

NOTICE INVITING TENDER (NIT) for

"Supply and Spreading of 125micron dust Sand and related work in dust tunnel building at T-5 track" at NATRAX, Pithampur, Dhar-Madhya Pradesh.

Tender No:NATRAX/PROC/PG-C&M/26/143

नेशनल ऑटोमोटिव टेस्ट ट्रैक्स (NATRAX) नेशनल ऑटोमोटिव बोर्ड (NAB) के तहत एक ऑटोमोटिव परीक्षण और प्रमाणन केंद्र है, जो भारत सरकार के भारी उद्योग मंत्रालय के तहत एक स्वायत्त निकाय है। NATRAX प्रूविंग ग्राउंड विश्व-स्तरीय परीक्षण और मूल्यांकन सेवाएं प्रदान करता है, जो राष्ट्रीय और अंतर्राष्ट्रीय मानकों के अनुसार दो/तीन पहियों से भारी वाणिज्यिक वाहनों तक सभी श्रेणियों के वाहनों के लिए उपयुक्त हैं।

National Automotive Test Tracks (NATRAX) is an Automotive Testing & Certification Centre under National Automotive Board (NAB) which is an autonomous body under Ministry of Heavy Industries, Government of India. NATRAX proving ground offers world-class testing and evaluation services catering for all categories of vehicles from two/three wheelers to heavy commercial vehicles as per National and International standards.

NATRAX, पीथमपुर, धार-मध्य प्रदेश में स्थित NATRAX कार्यालय में "टी-5 ट्रैक पर धूल सुरंग निर्माण में 125 माइक्रोन धूल रेत की आपूर्ति और फैलाव तथा संबंधित कार्य" के लिए दो बोली प्रणाली में सीलबंद निविदाएं आमंत्रित करता है।

NATRAX hereby invites sealed tenders in **TWO BID SYSTEM** for "Supply and Spreading of 125micron dust Sand and related work in dust tunnel building at T-5 track" at NATRAX, Pithampur, Dhar-Madhya Pradesh.

निविदासंख्या NATRAX/PROC/ PG-C&M/26/143 के अंतर्गत।

Under Tender No. NATRAX/PROC/ PG-C&M/26/143

कृपया ध्यान दें, NATRAX, आदेश संख्या P-45021/2/2017-पीपी (बीई-II) दिनांक 4 जून 2020, के अनुसार उद्योग और आंतरिक व्यापार, भारत सरकार के संवर्धन विभाग द्वारा जारी "सार्वजनिक खरीद (मेक इन इंडिया को प्राथमिकता), आदेश 2017- संशोधन" पर आदेश और इस संबंध में अन्य दिशानिर्देशों का पालन करेगा

Please note that, NATRAX shall follow the order on "Public Procurement (Preference to Make in India), Order 2017- Revision" issued by Department for Promotion of Industry and Internal Trade, Government of India, as per their Order Number P-45021/2/2017-PP (BE-II) dated 4th June 2020 and other guidelines in this regard.

The details of the tender are as mentioned below:

Particular	In Hindi	In English
Tender No.	NATRAX/PROC/ PG-C&M/26/143	NATRAX/PROC/ PG-C&M/26/143
Name of the work	"नेट्रैक्स, पीथमपुर, धार-मध्य प्रदेश में टी-5 ट्रैक पर धूल सुरंग निर्माण में 125 माइक्रोन धूल रेत की आपूर्ति और फैलाव तथा संबंधित कार्य।"	"Supply and Spreading of 125micron dust Sand and related work in Dust tunnel building at T-5 track at NATRAX, Pithampur, Dhar-Madhya Pradesh.
Minimum Eligibility Criteria/ न्यूनतम पात्रता मानदंड	1. कानूनी रूप से वैध इकाई: बोलों लगाने वाला अनिवार्य रूप से कानूनी रूप से वैध इकाई या तो मालिकाना फर्म, साझेदारी फर्म, प्राइवेट लिमिटेड कंपनी के रूप में होना चाहिए। जेवी/कंसोर्टियम के रूप में बोली लगाने वाले को अनुमति नहीं है	1. Legal Valid Entity: The Bidder shall necessarily be a legally valid entity either in the form of Proprietary firm, Partnership firm, Private Limited Company. Bidder in the form of JV/consortium is not permitted.
Minimum Eligibility Criteria/ न्यूनतम पात्रता	2. वित्तीय क्षमता: पिछले 3 वित्तीय कारोबार (2022-23, 2023-24 और 2024-25) में औसत वित्तीय कारोबार कम से कम 12.00 लाख रुपये होना चाहिए।	2. Financial Capacity: Should have the Average Financial turnover of at least Rs. 12 Lakhs in the last 3 financial years (2022-23, 2023-24 & 2024-25).

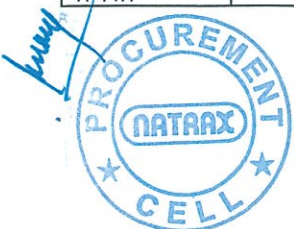

B/S

Minimum Eligibility Criteria/ न्यूनतम पात्रता मानदंड	3. तकनीकी क्षमता: पिछले 7 वर्षों में समान कार्य* घटक पूरा किया हो। i. अनुमानित लागत का कम से कम 80% का एक समान कार्य। ii. अनुमानित लागत के कम से कम 50% के दो समान कार्य। iii. अनुमानित लागत के कम से कम 40% के तीन समान कार्य।	3. Technical Capability: Should have completed <i>Similar works*</i> component in the last 7 years. i. One similar work of at least 80% of estimated cost. ii. Two similar works of at least 50% of estimated cost. iii. Three similar works of at least 40% of estimated cost.
	समान कार्य* - किसी भी केंद्रीय/राज्य सरकारी संगठनों/पीएसयू/प्रतिष्ठित निजी फर्मों में किसी भी ऑटोमोबाइल टेस्ट ट्रैक/प्रूविंग ग्राउंड/एक्सप्रेसवे/राष्ट्रीय राजमार्ग/राज्य राजमार्ग के लिए सड़क/ट्रैक कार्य के लिए "सिविल निर्माण/सिविल रखरखाव कार्य" से संबंधित कार्यों को सफलतापूर्वक पूरा किया गया।	Similar works* - Successfully completed works pertaining to "Civil Construction /Civil Maintenance work for road/Track work for any automobile test tracks/Proving Ground/Express way/National High way/State Highway in any Central/State Govt organizations/PSUs/Reputed Private firms.
Bid Security Amount (EMD)/ बोली सुरक्षा राशि (ईएमडी)	ईएमडी का मूल्य: Rs.14,000/-, राष्ट्रीय मोटर वाहन परीक्षण ट्रैक के पक्ष में होगा और पीथमपुर में एक शाखा वाले अनुसूचित बैंक से कम से कम 120 दिनों के लिए वैध निम्न में से किसी भी रूप में होगा (तकनीकी बोली के साथ संलग्न किया जाए)।	The value of the EMD shall be Rs. 14,000/- favoring National Automotive Test Tracks and shall be in any of the following forms valid for at-least 120 days from a scheduled bank having a branch at Pithampur. (To be enclosed along with the technical bid).
	1. पीथमपुर में देय डीडी।	1. DD payable at Pithampur.
	2. बैंक गारंटी।	2. Bank Guarantee.
	3. बैंकर्स चेक।	3. Banker's Cheque.
	4. फिक्स्ड डिपॉजिट रसीद	4. Fixed Deposit Receipt (FDR)
सरकारी दिशानिर्देशों के अनुसार, MSME/ स्टार्ट-अप्स के लिए ईएमडी छूट दी गई है	As per Govt guidelines, EMD is exempted for MSME/Start-ups	
Cost of tender documents/निविदा दस्तावेजों की लागत।: free of cost/मुफ्त		
Estimate cost/लागत का अनुमान लगाएं।	Rs.6,74,000/- (incl. GST)/₹ 6,74,000/- (जीएसटी सहित)	
Work Completion period/कार्य समाप्ति अवधि।	Two(2) months(Inclusive of rainy season)/ दो (2) महीने(बरसात के मौसम सहित)।	
Sale of Tender documents/ निविदा दस्तावेजों की बिक्री।	संपूर्ण निविदा दस्तावेज NATRAX की वेबसाइट www.natrax.in और cPPP पोर्टल पर निःशुल्क उपलब्ध हैं। इच्छुक बोलीदाता (a.prabhakar@natrax.in या natraxpithampur@gmail.com) पर ईमेल लिख सकते हैं या कार्यदिवसों में नीचे दिए गए कार्यालय पते पर जाकर सॉफ्ट कॉपी प्राप्त कर सकते हैं।	The complete "Tender Documents" can be downloaded from NATRAX website www.natrax.in and cPPP portal on free of cost. Interested bidders may write an email on (a.prabhakar@natrax.in,natraxpithampur@gmail.com) or collect soft copy by visiting below office address in working days.
	राष्ट्रीय ऑटोमोटिव टेस्ट ट्रैक (NATRAX) NH-52, पुराना आगरा-मुंबई राजमार्ग, पीथमपुर फ्लाईओवर के पास, खंडवा चौकी (पीथमपुर के पास), धार जिला, मध्य प्रदेश।	National Automotive Test Tracks (NATRAX) NH - 52 Old Agra-Mumbai Highway, Near to Pithampur Flyover, Post Khandwa (Near Pithampur), Dhar district, Madhya Pradesh.



13/3

<p>Submission Tender documents/ प्रस्तावित निविदा दस्तावेज़ जमा करें।</p>	<p>बिड ऑफ़लाइन मोड (या) ऑनलाइन मोड के माध्यम से जमा की जा सकती है। जो बिडर्स ऑनलाइन मोड के माध्यम से बिड सबमिट करना चाहते हैं, वे निम्न ईमेल आईडी पर भेज सकते हैं:</p> <p>a.prabhakar@natrax.in, natraxpithampur@gmail.com</p> <p>बिडर्स को तकनीकी बिड / वित्तीय बिड अलग-अलग जमा करनी चाहिए और दोनों फाइलों में अलग पासवर्ड सुरक्षा वाली फाइलें होनी चाहिए और पासवर्ड केवल NATRAX की लिखित अनुरोध पर ही प्रदान किया जाएगा, बिड सबमिशन के साथ नहीं।</p>	<p>Bids can be submitted through off-line mode (or) Online mode.</p> <p>BIDDERS INTERESTED TO SUBMIT BIDS THROUGH ONLINE MODE MUST SEND BIDS ON BELOW EMAIL ID'S.</p> <p>a.prabhakar@natrax.in, natraxpithampur@gmail.com,</p> <p>BIDDERS SHOULD SUBMIT TECHNICAL BIDS & FINANCIAL BIDS SEPERATELY AND BOTH FILES SHOULD CONTAIN SEPERATE PASSWORD PROTECTED FILES. PASSWORD(S) HAS TO BE PROVIDED ONLY ON WRITTEN REQUEST FROM NATRAX AND NOT ALONG WITH BID SUBMISSION.</p>
<p>Period of issue of tender documents./ टेंडर दस्तावेज़ों के जारी होने की अवधि।</p>	<p>From 24th April 2026 to 17:00 Hrs on 7th May 2026.</p>	
<p>The Last Date of receipt of pre bid queries, if any/ यदि कोई हो तो पूर्व-प्रस्ताव प्रश्नों की प्राप्ति की अंतिम तिथि।</p>	<p>Up to 17:00 Hrs on 29th April 2026.</p>	
<p>Date for Pre-Bid clarification meeting/ पूर्व-निविदा स्पष्टीकरण बैठक की तिथि।</p>	<p>30th April 2026 at 11:00 Hrs. (online mode & link will be shared seperately on written request from bidders on the above mentioned email ID)</p>	
<p>Last date/Time for submission of Sealed Bids/ सील बंद बोलियों के सबमिशन की अंतिम तिथि/समय।</p>	<p>Up to 15:00 Hrs on 8th May 2026, at HQ office NATRAX</p>	
<p>Date/Time of opening of technical bids/ तकनीकी बोलियों के खुलने की तिथि/समय।</p>	<p>15:30 Hrs on 8th April ^{MAY} 2026 at HQ office NATRAX</p>	
<p>अस्वीकरण</p> <ul style="list-style-type: none"> • NATRAX बिना कोई कारण बताए निविदा को अस्वीकार/ संशोधित/ रद्द करने का अधिकार सुरक्षित रखता है। • दस्तावेज़ को हिंदी और अंग्रेजी दोनों भाषाओं में तैयार किया गया है; हालाँकि किसी भी विसंगति के मामले में अंग्रेजी प्रबल होगी। 	<p>Disclaimer</p> <ul style="list-style-type: none"> • NATRAX reserves the right to reject/modify/cancel the tender without assigning any reason thereof. • The document has been prepared in both the language Hindi & English; however in case of any discrepancy the English shall prevail. 	
<p align="center">National Automotive Test Tracks (NATRAX) NH-52, Old Agra-Mumbai Highway, Near to Pithampur Flyover, Post Khandwa (Near Pithampur, Dist. Dhar (M.P). website: www.natrax.in Phone: +91-9893892310 Email: a.prabhakar@natrax.in; natraxpithampur@gmail.com</p>		

Head -Procurement & Stores

Pg 3/3





NATIONAL AUTOMOTIVE TEST TRACKS

TENDER DOCUMENTS FOR

**“Supply and Spreading of dust sand and related work at
Dust Tunnel Building at T-5 Track at NATRAX-
Pithampur” Dhar District, Madhya Pradesh.
(Supply and Spreading of 125 micron dust sand and related work)in Dust Tunnel
Building at T-5 Track)**

Tender No:NATRAX/PROC/PG-C&M/26/143

COVER PAGE

This Tender Contains:

1. Technical Bid:

- (i) Other Conditions of Contract (OCC)
- (ii) Technical Conditions of Contract (TCC)

2. Financial Bid

- (i) Letter of Financial Proposal
- (ii) Bill of Quantities (BOQ)

National Automotive Test Tracks (NATRAX)

NH-52, Old Agra- Mumbai Highway, Near to Pithampur Flyover, Post Khandwa (Near
Pithampur)

Dhar District, Madhya Pradesh-454774

Phone: +919893892310, Fax – 07292-256101

Email: a.prabhakar@natrax.in or natraxpithampur@gmail.com





Part/Section	Details	Ref. Page
Technical Bid		
Part 1	The Other Conditions of Contract (OCC)	
Section 1	Section 1- Technical Bid Submission Form	04
Section 2	Section 2- Disclaimer	05
Section 3	Section 3- Instructions to the Bidders	07
Section 4	Section 4- General Conditions of Contract (GCC)	25
Section 5	Section 5- Special Conditions of Contract (SCC)	26
Section 5.1	Section 5.1- Milestones - Deleted	
Section 6.0	Contract forms for Information and due acceptance	
Section 6.1	Form of Articles of Agreement	30
Section 6.2	Form for Sub Contractor's Warranty - Deleted	33
Section 6.3	Form of Performance Bank Guarantee	33
Section 7.0	Contract forms for Evaluation	
Section 7.1	Form for Financial capacity	37
Section 7.2	List of Equipment's	37
Section 7.3	Personal Capability-	38
Section 7.4	Technical Capability	38
Section 8	Section 8- Contact Details Form	39
Section 9	Section 9- Check List	40
Part 2	The Other Conditions of Contract (OCC)	
Section 10.1	Technical Specifications-	42
Section 10.2	Technical Specifications	42
Section 10.3	Technical Specifications	43
Section 11	Drawings	44
Section 12	Forms for pre-bid (Technical & Commercial) Queries	45
Financial Bid		
Section 13	Financial Bid submission form	46
Section 14	Bill of Quantities (BOQ)	47&48

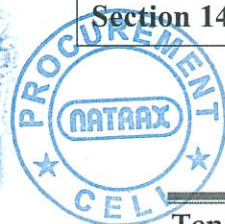



NATIONAL AUTOMOTIVE TEST TRACKS

TENDER DOCUMENTS FOR

**“Supply and Spreading of dust sand and related work at
Dust Tunnel Building at T-5 Track at NATRAX-
Pithampur” Dhar District, Madhya Pradesh.**
(Supply and Spreading of 125 micron dust sand and related work)in Dust Tunnel
Building at T-5 Track)

Tender No:NATRAX/PROC/PG-C&M/26/143.

COVER PAGE- OTHER CONDITIONS OF CONTRACT (OCC)

This Tender Contains:

1. The Other Conditions of Contract (OCC) in the following parts:
 - Section 1- Technical Bid Submission Form
 - Section 2- Disclaimer
 - Section 3- Instructions to the Bidders
 - Section 4- General Conditions of Contract (GCC)
 - Section 5- Special Conditions of Contract (SCC)
 - Section 5.1- Milestones
 - Section 6- Contract Forms for information and due acceptance.
 - 6.1 Form of Articles of Agreement
 - 6.2 Form for Sub Contractor's Warranty-Deleted
 - 6.3 Form of Performance Bank Guarantee
 - Section 7- Contract forms for evaluation.
 - 7.1 Form for Financial capacity
 - 7.2 List of Equipment's
 - 7.3 Personal Capability
 - 7.4 Technical Capability
 - Section 8- Contact Details Form
 - Section 9- Check List

National Automotive Test Tracks (NATRAX)

NH-52, Old Agra- Mumbai Highway, Near to Pithampur Flyover, Post Khandwa (Near Pithampur)
Dhar District, Madhya Pradesh-454774
Phone: +919893892310, Fax – 07292-256101

Email: a.prabhakar@natrax.in or natraxpithampur@gmail.com





Section-1- TECHNICAL PROPOSAL SUBMISSION FORM

LETTER OF BID

[Location, Date]

To,

The Head Procurement & Stores

NATIONAL AUTOMOTIVE TEST TRACKS (NATRAX)

Agra – Mumbai Highway (NH – 52),

Next to Pithampur Flyover,

Post- Khandwa (Near Pithampur) Dist. Dhar

Madhya Pradesh – 454774

Email:natraxpithampur@gmail.com or a.prabhakar@natrax.in

Ref: Tender No. -----

We, the undersigned, declare that “We have examined and have no reservations to the Bidding Documents, including Addenda issued in accordance with Instructions to Bidders. We offer to execute in conformity with the Bidding Documents of the following Works **“Supply and Spreading of dust sand and related work at Dust Tunnel Building at T-5 Track at NATRAX- Pithampur” Dhar District, Madhya Pradesh(Supply and Spreading of 125 micron dust sand and related work)in Dust Tunnel Building at T-5 Track) under Tender No: NATRAX/PROC/PG-C&M/26/143.**

Bid shall be valid for a period of **120 days** from the actual date of submission of bid, in accordance with the Bidding Documents, and it shall remain binding upon us and may be accepted at any time before the expiration of that period.

- (a) If our bid is accepted, we commit to obtain a performance security in accordance with the Bidding Documents,
- (b) We are not associated nor have been associated in the past, directly or indirectly, with a consultant, or any other entity that has prepared the design, specifications and other documents for this Invitation for Bids.
- (c) We also declare that the Government of India Or any Govt. bodies has not declared us, and any of our Sub contractors or Consultants for any part of the Contract ineligible or black listed on charges of engaging in corrupt, fraudulent, collusive or coercive practices or any failure/lapses of serious nature.
- (d) We understand that you are not bound to accept the highest ranked bid or any other bid that you may receive.

Yours sincerely,

Authorized Signature [In full]:

Authorized Signature [In initials]:

Name and Title of Signatory:

Name of Firm:

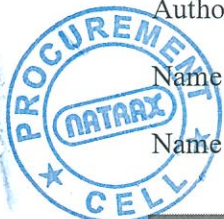



Address:

[Note1: Authorized person signing shall attach to this document a proof of authorization for signing on behalf of the Bidder Company]

[Note2: To be signed in blue ink]

[Note3] To be executed on Bidder's letter Head.

SECTION-2- DISCLAIMER

- 2.1. NATRAX is an Automotive Testing & Certification Centre under NATIONAL AUTOMOTIVE BOARD (NAB). NATRAX Centre is being set up on approx. 3000 acres for comprehensive Testing & evaluation of all type of automobiles near Pithampur, Dist. Dhar (Madhya Pradesh, India).

This Bidding Document ("Bidding Document") has been prepared by (NATRAX/ Employer") for the purpose of providing certain information to the entities, who have been participated in this open tender, through a competitive bidding process for the selection of a bidder for "Tender document for **Supply and Spreading of dust sand and related work in Dust Tunnel Building at T-5 Track at NATRAX- Pithampur Dhar District, Madhya Pradesh**" (Supply and spreading of 125micron dust sand and related work in Dust Tunnel Building at T-5 Track)- under Tender No: Tender No:NATRAX/PROC/PG-C&M/26/143

The information contained in the Bidding Document is being provided for the limited purposes of enabling the bidders to prepare and submit a bid and for no other purpose. Under no circumstances shall NATRAX, or its respective advisors, consultants, contractors, servants and/or agents incur any liability arising out of or in respect of the issue of this Bidding Document or the selection procedure.

- 2.2. This Bidding Document is being made available by NATRAX to the bidders on the terms set out in this Bidding Document. The transfer, possession or use of this Bidding Document in any manner contrary to any applicable law is expressly prohibited. The bidders shall inform themselves concerning, and shall observe any applicable legal requirements.
- 2.3. This Bidding Document is a summary of available information and no reliance shall be placed on any information or statements contained herein, and no representation or warranty, expressed or implied, is or will be made in relation to such information and no liability is or will be accepted by NATRAX, its respective advisers, consultants, contractors, servants and/or its advisers in relation to the accuracy, adequacy or completeness of such information or statements made, nor shall it be assumed that such information or statements will remain unchanged.
- 2.4. The information does not purport to be comprehensive or to have been independently verified. Nothing in this Bidding Document shall be construed as legal, financial or tax advice. NATRAX will not be liable for any costs, expenses, however so incurred by the bidders in connection with the preparation of their bids.
- 2.5. NATRAX reserves the right to amend this Bidding Document and any information contained herein at any time by a notice, in writing, to the bidders.





- 2.6. Nothing in this Bidding Document is, nor shall be relied upon as, a promise or representation as to NATRAX's ultimate decision in the selection of the successful bidder as to undertake the work ("Contractor"). NATRAX expects to shortlist the successful bidder (s) in accordance with this Bidding Document on the basis of the bids submitted. The bidder(s) shall not, therefore, assume that they will have the opportunity to revise their bids following submission and before short-listing, except as provided in this Bidding Document. However, NATRAX reserves the right to change the basis of or the procedures (including the timetable) relating to the bidding process, reject any, or all, of the bids, not to invite a bidder to proceed further, not furnish a bidder with additional information nor otherwise to negotiate with a bidder in respect of the works or the selection of the Contractor at any time. NATRAX does not undertake to accept the lowest or indeed any bid.
- 2.7. No person other than [HEAD PROCUREMENT & STORES] has been authorised by NATRAX to give any information or to make any representation not contained in this Bidding Document and, if given or made, any such information or representation shall not be relied upon as having been so authorised.
- 2.8. Nothing contained in this Bidding Document is, or shall be relied upon as, a representation of fact or promise as to the future. Any summaries or descriptions of documents or contractual arrangements contained in any part of this Bidding Document are only indicative and cannot be and are not intended to be comprehensive, nor any substitute for the underlying documentation (whether existing or to be concluded in the future), and are in all respects qualified in their entirety by reference to them.
- 2.9. NATRAX, its respective advisers, consultants, contractors, servants and/or agents do not accept any responsibility for the legality, validity, effectiveness, adequacy or enforceability of any documentation executed, or which may be executed, in relation to the selection and appointment of a Contractor. No legal or other obligation shall arise between any bidder and NATRAX unless and until a binding contract ("Contract") has been formally executed by NATRAX and the Contractor and any conditions precedent to the effectiveness of the Contract have been fulfilled. NATRAX shall not be obliged to appoint any of the bidders to undertake the performance, execution and implementation of the work and NATRAX reserves the right not to proceed with the selection procedure and to withdraw from the selection procedure, or any part thereof, at any time.
- 2.10. Nothing in this Bidding Document shall constitute the basis of the contract or the selection of the contractor nor shall such documentation/ information be used in construing any such Contract. Each bidder must rely on the terms and conditions contained in any contract, when, and if, finally executed, subject to such limitations and restrictions which may be specified in such contract. Reference is drawn to the Special Conditions of Contract (SCC) which shall form a part of the Contract.
- 2.11. The bidder(s) are prohibited from any form of collusion or arrangement (directly or through their respective advisors or consultants) in an attempt to influence the award process. Giving or offering of any gift, bribe or inducement or any attempt to any such act on behalf of a bidder towards any officer/ employee of NATRAX or to any other person in a position to influence the decision of NATRAX for showing any favour in relation to this selection process or any other contract, shall render such bidder to such liability/penalty as NATRAX may deem proper, including but not limited to rejection of the bid of the bidder.





- 2.12. The laws of the Republic of India shall be applicable to this Bidding Document. The Courts at Madhya Pradesh shall have exclusive jurisdiction in relation to any disputes arising from this Bidding Document.
- 2.13. This Bidding Document is confidential and personal to each bidder. The bidders shall not disclose any of Confidential Information given in the tender document to any person or body corporate except to the extent permitted under this Bidding Document. The bidders shall promptly return this Bidding Document to NATRAX upon request or as specified in this Bidding Document. Any failure to furnish or comply with the terms of the Letter of Undertaking shall entitle NATRAX to disqualify the relevant bidder.
- 2.14. Each bidder's acceptance of delivery of this Bidding Document constitutes its agreement to, and acceptance of, the terms set forth in this Disclaimer.

SECTION-3- INSTRUCTIONS TO THE BIDDERS (ITB)

1.1. GENERAL INSTRUCTIONS

- 1.1.1. National Automotive Test Tracks (NATRAX) is an test centre under National Automotive Board, an autonomous body constituted by Ministry of Heavy Industries, Government of India for execution of National Automotive Test Tracks (NATRAX).

National Automotive Test Tracks (NATRAX) "Employer", is an Automotive Testing & Certification Centre under NAB. NATRAX is being set up on approx. 3000 acres for comprehensive Testing & evaluation of all type of automobiles near Pithampur, Dist. Dhar (Madhya Pradesh, India).

NATRAX herewith invites sealed Bids in two packet system from the reputed firm/agencies who meet the minimum eligibility criteria as mentioned below for the works, "**Supply and Spreading of dust sand and related work in Dust Tunnel Building at T-5 Track**" at NATRAX- Pithampur" Dhar District, Madhya Pradesh"(Supply and spreading of 125micron dust sand and related work in Dust Tunnel Building at T-5 Track)- under Tender No: Tender No:NATRAX/PROC/PG-C&M/26/143

Those who meet the minimum eligibility criteria as mentioned in this section (and also in NIT) may only be eligible to become successful in the bidding process. **The bidder in the form of JV/Consortium is not permitted.** The details of the tender are as mentioned below.





Description of works	Period of Completion	Estimated Cost	EMD Amount	Date of Prebid meeting	Date for submission of Bids	Date of opening of Bid
“Supply and Spreading of dust sand and related work in Dust Tunnel Building at T-5 Track” at NATRAX-Pithampur- Dhar District, Madhya Pradesh. under Tender No:NATRAX/PROC/PG-C&M/26/143	02 months from the date of issue of ‘NTP’	Rs 6.74 lakhs (all inclusive GST)	INR 14,000 or Exempted as per MSME/Start-Ups	30th April 2026 को 11.00 बजे / 11.00 Hrs on 30th April 2026 through online mode	Up to 15.00 Hrs on 8 th May 2026, at HQ office NATRAX Pithampur Distt. Dhar (M.P.)	8 th May 2026 at 15.30 Hrs at NATRAX HUB/ at NATRAX, Pithampur.

1.1.2. The term “Employer”, mentioned in any part of this tender documents means, NATRAX. For all the purpose of bidding, selection process and clarifications, the Employer is represented by **Head Procurement & stores**.

1.1.3. While all efforts have been made to avoid errors in the drafting of the tender documents, the Bidder is advised to check the same carefully. No claim on account of any errors detected in the tender documents shall be entertained.

1.1.4. The Employer desires that the bidders, suppliers, and contractors under the Project, observe the highest standard of ethics during the performance, procurement and execution of such contracts. In pursuance of this requirement, the Employer:

Defines, for the purposes of this provision, the terms set forth below:

- (i) “Corrupt Practice” means the offering, giving, receiving, or soliciting, directly or indirectly, anything of value to influence improperly the actions of another party;
- (ii) “Fraudulent Practice” means any act of submission of forged documentation, or omission, including a misrepresentation, that knowingly or recklessly misleads, or attempts to mislead, a party to obtain a financial or other benefit or to avoid an obligation, or to succeed in a competitive bidding process;
- (iii) “Coercive Practice” means impairing or harming, or threatening to impair or harm, directly or indirectly, any party or the property of the party to influence improperly the actions of a party;
- (iv) “Collusive Practice” means an arrangement between two or more parties designed to achieve an improper purpose, including influencing improperly the actions of another party.

- (a) Will reject the award of Contract, even at a later stage, if it determines that the bidder recommended/ selected for award/awarded has, directly or through an agent, engaged in Corrupt, Fraudulent, Collusive, Or Coercive Practices in competing for the Contract;





- (a) Will reject the award of Contract, even at a later stage, if it determines that the bidder recommended/ selected for award/awarded has, directly or through an agent, engaged in Corrupt, Fraudulent, Collusive, Or Coercive Practices in competing for the Contract;
 - (b) Will sanction a party or its successors, including declaring ineligible, either indefinitely or for a stated period of time, to participate in any further bidding/ procurement proceedings under the Project, if it at any time determines that the party has, directly or through an agent, engaged in Corrupt, Fraudulent, Collusive, Or Coercive Practices in competing for, or in executing, the contract; and
 - (c) Will have the right to require the bidders, or its suppliers, contractors and consultants to permit the Employer to inspect their accounts and records and other documents relating to the bid submission and contract performance and to have them audited by auditors appointed by the Employer at the cost of the bidders.
 - (d) The Bidder must obtain for himself on his own responsibility and at his own expenses all the information which may be necessary for the purpose of making a bid and for entering into a contract, must examine the Drawings, must inspect the sites of the work, acquaint himself with all local conditions, means of access to the work, nature of the work and all matters pertaining thereto. The Employer will in no case be responsible or liable for those costs, regardless of the conduct or outcome of the bidding process.
- 1.1.5. Each page of the Tender documents should be stamped and signed by the person or persons submitting the Tender in token of his/their having acquainted himself/ themselves and accepted the entire tender documents including various conditions of contract. Any Bid with any of the documents not so signed is liable to be rejected at the discretion of NATRAX. The signatures shall be in blue ink.
- 1.1.6. The tender prepared by the Bidder and all correspondence and documents relating to the tender exchanged between the Bidder and NATRAX shall be in the English language.
- 1.1.7. The bidder shall attach the copy of the authorization letter/power of Attorney as the proof of authorization for signing on behalf of the Bidder.
- 1.1.8. The contract shall be governed by NATRAX's General Conditions for Contract (GCC), Special Conditions for Contract (SCC), Technical Conditions for Contract (TCC) and all other relevant conditions & documents on the tender documents.
- 1.1.9. The Bidders are expected to carefully examine all the contents of the tender documents including instructions, conditions, terms, specifications, drawings and get clarifications, if required, from NATRAX and take them fully into account before submitting their offer. Failure to comply with the requirements as detailed in these documents shall be at the Bidder's own risk. Bidders which are not responsive to the requirements of the tender documents **will be rejected**.
- 1.1.10. All Bidders are hereby explicitly informed that conditional offers or offers with deviations from the conditions of Contract, the bids not meeting the minimum eligibility criteria, Technical Bids, not accompanied with EMD of requisite amount in acceptable format, Bids in altered/modified formats, or in deviation with any other requirements, stipulated in the tender documents are **liable to be rejected**.
- 1.1.11. The Bid submitted on behalf of a Firm shall be signed by all the Partners of the Firm or by a Partner who has the necessary authority on behalf of the Firm to enter into the proposed contract. Otherwise, **the bid is liable to be rejected by the NATRAX**.





The bidders are expected to meet the minimum eligibility criteria as given in the Notice Inviting Tender to participate in this tender. **NATRAX will reject the Bids that do not meet the minimum eligibility criteria as laid down, based on their submission along with the tender documents, even after the bid opening process is concluded.**

1.1.12. The 'contact details form' need to be filled, signed and submitted to NATRAX within 3 days of purchase of tender. NATRAX will use such details to communicate via e-mail with the bidder for issuing addenda/corrigendum, including the change of key tendering dates, revisions etc. NATRAX will not be responsible for non receipt of any such communication to the bidders, who have not submitted the contact details form.

1.1.13. The tender is issued to all bidders as soft copy through email if required by agency as per request and Tender document may download from our website www.natrax.in. The bidders shall not tamper or modify any part of the tender documents in any manner, other than certain forms/BOQ, allowed as per conditions of tender. In case of any discrepancy between editable/PDF formats, PDF formats will supersede. In case in part of the bid is found to be tampered or modified, the bids are liable to be rejected and the full earnest Deposit will be forfeited and liable to be banned from from doing any business with NATRAX.

1.1.14. Bidder in the form of JV/consortium is not permitted. Preference shall be given to bidders as per Order No. P-45021/2/2017-PP (BE-II) dated 4th June 2020, issued by Department for Promotion of Industry and Internal Trade, Government of India subject to submission of necessary documents in this regard by the bidders.

1.2. MINIMUM ELIGIBILITY CRITERIA

The qualification will be based on Bidder's meeting all the following minimum **pass/fail** criteria regarding their particular experience, financial position, personnel and equipment capabilities and other relevant information as demonstrated by the Bidders responses in the forms attached. **The qualifications, capacity and resources of proposed sub-contractors will not be taken into account in determining the Bidders compliance with the qualifying criteria.**

The bidder whose bid meet the following minimum eligibility criteria would only be considered as responsive and evaluated by NATRAX.

- i. **MEC-1 Legally Valid Entity:** *The Bidder shall necessarily be a legally valid entity either in the form of Proprietary firm, Partnership firm, Private Limited Company. Bidder in the form of JV/consortium is not permitted. A proof for supporting the legal validity of the Bidder shall be submitted.*
- ii. **MEC-2 Financial Capacity:** *Should have the Average Financial turnover of at least Rs. 12 Lakhs in the last 3 financial years (2022-23, 2023-24 & 2024-25). Documentary evidence in the form of certified Audited Balance Sheets of relevant periods or a certificate from the Chartered Accountant / Cost Accountant indicating the turnover details for the relevant period shall be uploaded with the bid.*

In case the date of constitution / incorporation of the bidder is less than 3-year-old, the average turnover in respect of the completed financial years after the date of constitution shall be taken into account for this criterion. Relevant proof for supporting the above shall be submitted or certificate from CA will be required as suggested in Section 7.1.





iii. **MEC-3 Technical Capability:** Should have completed **Similar works*** component in the last 3 years meeting the following criteria:

- (a) One similar completed work costing not, not less than @ **80% of estimated cost.**
(OR)
- (b) Two similar completed works costing not, not less than @ **50% of estimated cost.**
(OR)
- (c) Three similar completed works costing not, not less than @ **40% of estimated cost.**

“Similar Works* Successfully completed works pertaining/having experience to Civil Construction/Civil Maintenance work for Road/Track work for any Automobile Test Tracks/Proving Ground/Express way/National High Way/State High way in any Central/State Govt.Organizations/PSUs/Reputed Pvt.Firms.

Copy of valid LOA/Agreement/Work order & completion certificate.

*For the purpose of assessment of technical capability, the latest cutoff date of work is **30 days prior to last date of submission of Bid Document.***

As the proof for having fully adhered to the minimum eligibility criteria at para (3), NATRAX shall accept the self-attested completion certificates issued by Govt. Depts/Autonomous bodies/PSUs/reputed private firms/automobile manufacturers/Pvt. Ltd. Firms (at the discretion of NATRAX) only. In case of submission of certificates from the private firms, the TDS certificate in support of the certificate issued by the private firms shall also be submitted. Any document other than the above will not be accepted by NATRAX.

- v **EMD amount:** Rs.14,000/-shall be submitted in favour of “National Automotive Test Tracks payable at Pithampur in the form of Demand Draft/Bank Guarantee/Banker’s Cheque/Fixed Deposit Receipt(FDR) or EMD shall be Exempted MSME Registered vendors as per Govt guidelines.

1.3. SITE VISIT

1.3.1. The Bidders are advised to visit and examine the Site of Works and its surroundings, with prior notice to NATRAX, at his/their cost and obtain for himself / themselves on his/their own responsibility, all information that may be necessary for preparing the tender and entering into a Contract. The Bidder shall be deemed to have inspected the Site and its surroundings before hand and taken into account all relevant factors pertaining to the site in the preparation and submission of the Tender.

1.3.2. The bidder and any of its personnel or agents will be granted permission by the Employer to enter upon its premises and lands for the purpose of such visit, but only upon the express condition that the bidder, its personnel, and agents, will release and indemnify the Employer and its personnel and agents from and against all liability in respect thereof, and will be responsible for death or personal injury, loss of or damage to property, and any other loss, damage, costs, and expenses incurred as a result of the inspection.



1.3.3. **Address of the Site: National Automotive Test Tracks (NATRAX),NH-52, Old Agra- Mumbai Highway, Near to Pithampur Flyover,Post Khandwa (Near Pithampur),Dist. Dhar (M.P.)-454774.**

1.4. SPECIFIC INSTRUCTIONS ON WORKS

1.4.1. The detailed scope of works are described under Technical Conditions of Contract (TCC), along with the detailed specifications, drawings, bill of quantities etc.

1.4.2. The successful bidder has to start the works simultaneously so as to complete the works within the specified completion period.

1.4.3. The sub-contractor, if any proposed by the successful bidder, after award of work, should have adequate experience, own/established access to required man power, machineries and construction equipments and the contractor shall get prior approval from NATRAX before the start of the work.

1.4.4. The work shall be carried out strictly in accordance with the specifications given in the tender and also in compliance of the requirements of the Authorities concerned and deviation on any account will not be permitted.

1.4.5. The Bidder shall carry out all the works strictly in accordance with Drawings, details, specifications, standard engineering practices and instructions of NATRAX or NATRAX's authorized representative. In case the changes that have been made in the design by NATRAX during execution, the Bidder shall have to carry out the same within the provisions of contract and mutually agreed terms and conditions.

1.4.6. The successful Bidder must co-operate with the other contractors/suppliers and representatives appointed by NATRAX to ensure that the work proceeds smoothly with the least possible delay and to the satisfaction of NATRAX.

1.4.7. The successful Bidder is bound to carry out the works, that consists of any minor/sub items, necessary for the completion of the works as covered in this tender to achieve end results and conventionally included in works, even though such minor/sub items are not included in the Bill of quantities and drawings, are deemed to be priced in the other items/works. No separate claim on this account shall be entertained, unless it is explicitly brought to the notice of NATRAX in writing before the start of such item works and accepted by NATRAX.

1.4.8. The works/services under this tender will be governed by item rate contract.

1.4.9. In case the work is awarded in parts by splitting the contract among the bidders and the other works such as services/ utilities which may be done simultaneously by NATRAX's other specialized agencies, then the works to be carried out in co-ordination with such agencies for integration of works by overlapping various activities.

1.5. TIME SCHEDULE FOR COMPLETION OF WORKS

1.5.1. Time is the essence of the contract. The work is to be completed within the stipulated time i.e. **02 (Two) months** from the date of issue of '**Notice to Proceed**' to the successful Bidder.

1.5.2. Time allowed for carrying out the works as mentioned in the tender documents shall be strictly observed by Bidder and it shall be reckoned from the date of issue of '**Notice to Proceed**'. **In the event of urgency this may also be consider from the date of Issue of LoA if the same is desired by NATRAX.**





1.6. EARNEST MONEY DEPOSIT (BID SECURITY AMOUNT)

- 1.6.1. The bids should be accompanied by an Earnest Money Deposit as specified in the form of Bank Guarantee / Banker's Cheque / Demand Draft /Fixed Deposit , drawn in favour of *National Automotive Test Tracks, payable at Pithampur valid for 120 days, from any of the scheduled bank in India*. The BG issued by any scheduled bank in India in bank's own approved format is acceptable to NATRAX.
- 1.6.2. A tender which is not accompanied by such Earnest Money Deposit will be rejected.
- 1.6.3. **NATRAX reserves the right of forfeiture of Earnest Money Deposit in case, the bidder:**
- Does not reply to any queries raised by NATRAX, within the stipulated period that may be raised after opening of the technical or financial bids.
 - After opening the financial bids, revokes his technical/financial offer or alters any of the quoted rates/conditions of tender.
 - Does not accept the corrections made by NATRAX to its Bid Price, pursuant to examination of financial proposal and correction of arithmetical errors.
 - Has not accepted '**Letter of Acceptance**' within the stipulated time.
 - Fails to provide/ furnish the Performance Bank Guarantee within stipulated period as mentioned in the Letter of Acceptance.
- 1.6.4. In case of forfeiture of EMD, the Bidder shall be debarred from the bidding, incase of Re-invitation of bids and all forthcoming tenders of NATRAX.

1.7. PRE-BID MEETING

- 1.7.1. The bidder or his official representative is invited to attend a pre-bid meeting, which, if convened, will take place at the NATRAX Site, **National Automotive Test Tracks (NATRAX),NH-52, Old Agra- Mumbai Highway,Near to Pithampur Flyover,Post Khandwa (Near Pithampur),Dist. Dhar (M.P.)-454774**

Virtual meeting Link of the meeting shall be shared only with those who submit their pre-bid query by 17.00 Hrs on 29th April 2026

- 1.7.2. The purpose of the meeting will be to clarify issues and to answer questions on any matter that may be raised at that stage.
- 1.7.3. The bidder is requested, to submit any questions in writing, e-mail or by fax, to reach the Employer not later than **11.00 Hrs on 30th April 2026**.
- 1.7.4. Minutes of the meeting, including the text of the questions raised and the responses given, together with any responses prepared after the meeting, will be issued without delay to all purchasers of the bidding documents. Any modification of the bidding documents listed in Sub-Clause which may become necessary as a result of the pre-bid meeting shall be made by the Employer exclusively through the issue of an Addendum, vide Clause 8 and not through the minutes of the pre-bid meeting.





1.7.5. Non-attendance at the pre-bid meeting will not be a cause for disqualification of a bidder.

1.8. AMENDMENT TO THE TENDER DOCUMENT

1.8.1. Any amendment to the tender document may be issued to the bidders through addendum/ corrigendum, prior to date of opening of the tenders, to intimate the bidders regarding revisions/changes/modifications to tender documents, changes in the key tendering dates, clarifications on queries raised by the bidders etc. All such communications to the bidder would be in the form of soft copy and may sent to the bidder's **E-mail ID as mentioned in the 'contact details form', submitted by the bidder within 3 days after the purchase of tender documents or e-published on NATRAX and/or Govt.'s e-procurement portals.**

1.8.2. In order to afford prospective bidders, reasonable time for preparing their tenders after taking into account such amendments, NATRAX may, at its discretion, extend the deadline for submission of tenders.

1.8.3. Addendum/corrigendum shall be an integral part of the tender and required to be complied as per para-10, 'Instructions for preparation of bids'.

1.8.4. A prospective bidder requiring any clarification of the bidding documents may notify the Employer in writing or by e-mail/Fax at the Employer's address indicated in the Tender document. The Employer will respond to any request for clarification, which he receives earlier than 7 days prior to the deadline for submission of bids. Copies of the Employer's response will be forwarded to all purchasers of the bidding documents, including a description of the inquiry but without identifying its source. NATRAX will not be held responsible for non receipt of any such communication to the bidders, who have not submitted the contact details form within 3 days of receipt of tender document.

1.9. VALIDITY OF BIDS

1.9.1. Bids shall remain valid and open for acceptance for a period of **120 days** from the last date of submission of Bids.

1.9.2. If a bidder withdraws or revokes his offer or revises the quoted rate or condition for any item within the aforesaid period, his Earnest Money Deposit is liable to be forfeited.

1.9.3. In case NATRAX calls the bidder for negotiations then this shall not amount to cancellation or withdrawal of original offer which shall be binding on the bidder.

1.9.4. Any Bid having validity lower than that specified above shall be rejected by NATRAX as being non responsive. However, NATRAX may request the Bidders in writing to extend the Bid unconditionally beyond the Bid validity period up to an additional period of sixty (60) days without any modification and with out giving any reason thereof on exceptional cases. Conditional extension of bid validity shall not be accepted and NATRAX reserves right to reject such bid/s and proceed with the bidding process with the remaining bidders.



1.10. INSTRUCTIONS FOR PREPARATION OF BIDS

CONTENTS OF THE BIDDING DOCUMENT

(I) THE TECHNICAL BID CONTAINS THE FOLLOWING SECTIONS:

Other Conditions of Contract (OCC)

Section 1- Technical Bid Submission Form

Section 2- Disclaimer

Section 3- Instructions to the Bidders

Section 4- General Conditions of Contract (GCC)

Section 5- Special Conditions of Contract (SCC)

Section 6- Contract Forms for information and due acceptance.

6.1 Form of Articles of Agreement

6.2 Form for Sub Contractor's Warranty

6.3 Form of Performance Bank Guarantee

Section 7- Contract forms for evaluation.

7.1 Form for Financial capacity

7.2 Form for technical Capability

7.3 Personal Capability

7.4 Technical Capability

Section 8- Contact Details Form

Section 9- Check List

The Technical Conditions of Contract (TCC):

Section 10 - Detailed Technical Specifications.

Section 11- Drawings.

Section 12- Forms for Technical & Commercial Queries





THE FINANCIAL BID CONTAINS THE FOLLOWING SECTIONS:

Section 13- Financial Bid Submission Form

Section 14- BOQ (Bill of Quantities for Financial Quotes)

A. PREPARATION FOR TECHNICAL BID (To be packed in a separate envelope)

1.10.1. The Tender Documents are available in our website: www.natrax.in and the Bidders shall take printouts of all the documents (including all drawings) in paper size A4, (prints on both sides, colour/B&W are accepted) and shall be bound in proper manner, in the order of Section Nos. and the pages shall be serially numbered. All pages need to be stamped and signed.

Wherever editable format is used, (Technical bid submission form) it shall be inserted duly filled and signed at appropriate places. Bidders shall not change/tamper any content of the formats, font size or orientation in any of the editable/PDF formats.

1.10.2. The addenda (corrigendum) issued by NATRAX shall also be signed and submitted in paper size A-4.

1.10.3. The Technical Bid shall also contain the additional documents required to be submitted as per the MEC at clause 2, (as above) for the purpose of evaluation of Bids and it shall be bound separately with all pages numbered serially. **The Bidder may avoid unwanted documentations, which are not sought as the part of tender.**

B. PREPARATION FOR FINANCIAL BID (To be packed in a separate envelope)

1.10.4. The financial Bid submission form (issued in editable format) shall be prepared duly filling (only) the required information, stamped and signed at appropriate places. Bidders shall not edit/change/tamper any of the content of the format, font size or orientation, other than the information which are the required to be filled, under the provisions of tender.

1.10.5. The financial bid (BOQ) shall be PREFERABLY prepared separately in paper size A3 and shall be bound properly with each page serially numbered. In case of any revision/change/modification on financial bid format, only on the latest format shall be used for preparation of the financial bid. Submissions on old/previous formats are liable to be rejected.

1.10.6. The prices shall be quoted in Indian Rupees only. The bidder must quote their price strictly as per the items as described in the BOQ and shall be inclusive of all taxes and duties.

1.10.7. **The quoted rates shall preferably be a round figure, without any fraction and if unavoidable, in the opinion of the Bidder, it shall be limited to maximum of 2 (two) decimals.** Anything beyond two decimals will not be considered.

1.10.8. If requested, the financial Bid (BOQs) shall be issued as soft copy in excel formats, locked with password protected columns, except for the price columns, where the bidder need to fill his rate in figures and words and total amount in Figures. These columns are open for editing purpose and it has not been prefixed with any kind of arithmetical formulae for generating the total automatically. The Bidder shall use its own methods for arithmetical calculation of bid prices. Bidder shall either enter the prices in figures and words directly on the soft copy OR may fill the columns for the





prices in figures and words by hand writing with pen, (blue Ink) in a clear and legible manner. The BOQs in PDF formats are also attached and in case of discrepancy this will supersede over the editable formats.

1.10.9. Any corrections / over-writing made by the bidder in his own hand written entries shall be stamped and signed by them against the respective entries.

1.10.10. The items which are not specifically detailed in the BOQ item description, but are part of the item as per standard engineering practices, are deemed to be included in the respective price and no separate / additional amount in price will be permitted for the same. The bidder shall also consider the relevant tender clause to finalise their bid price.

1.10.11. The Bidders are required to submit their Bid in a **single sealed envelope** containing **two separate** packets and the outer envelope shall be superscribed "**Bid for Tender No: NATRAX/PROC/PG-C&M/26/143**", with the Name and address of the Bidder.

The said outer envelope shall contain the following **sealed envelopes**:

(a) **Financial Bid**, as given in the Tender or its latest revision issued by NATRAX, in a **separate sealed envelope**, superscribed "**Financial Bid for Tender No: NATRAX/PROC/PG-C&M/26/143**", with the Name and address of the Bidder.

(b) **Technical Bid**, as given in the Tender, along with all required additional information, documents in support of the minimum eligibility criteria, the addenda/corrigendum if any issued by NATRAX and Valid EMD of requisite amount, in a **separate sealed envelope**, superscribed "**Technical Bid for Tender No: NATRAX/PROC/PG-C&M/26/143**", with the Name and address of the Bidder.

1.11. INSTRUCTIONS FOR SUBMISSION OF BIDS

1.11.1. The Bids (in offline form) shall be submitted within the stipulated time period at site office of NATRAX Site, National Automotive Test Tracks (NATRAX), NH-52, Old Agra- Mumbai Highway, Near to Pithampur Flyover, Post Khandwa (Near Pithampur), Dist. Dhar (M.P.)-454774.

(OR)

The bids (Technical and Financial bids) in online form are to be submitted by the Bidder(s) in **Password protected form** at the following email ID's not later than the aforesaid time & date or as next convenient date & time on pre-intimation. (for password protection details please refer relevant pages of this document). Password shall be shared by the bidders as requested by NATRAX through mail at time opening of Technical and Financial bids only.

Email to: a.prabhakar@natrax.in, natraxpithampur@gmail.com

1.11.2. Bids sent telegraphically or through other means of transmission (telefax, e-mail etc.) which cannot be delivered in a sealed envelope shall be treated as non-responsive, invalid and shall be rejected.



1.11.3. The Bids will be opened as scheduled at site office of NATRAX Site, National Automotive Test Tracks (NATRAX),NH-52, Old Agra- Mumbai Highway,Near to Pithampur Flyover,Post Khandwa (Near Pithampur),Dist. Dhar (M.P.)-454774 in the presence of Bidders or their duly authorised representatives who choose to remain present at the time of opening the tender.

1.11.4. No Bid will be accepted after the aforesaid date and time. However on exceptional cases NATRAX reserves right to extend the time/last date of submission of bids to a next convenient time/date, before opening of the Technical bids.

1.12. WITHDRAWAL OF BID

1.12.1. No Bidder is permitted to withdraw their already submitted bid after the the last date/time of submission of bids. Incase of bids send by courier/post etc. can be withdrawn before the closure of last date /time for submission of bids, on written request from the bidder.

1.13. BID OPENING PROCEDURE

1.13.1. The bids shall be opened in the presence of bidders or their duly authorized representatives at the time mentioned in the tender/corrigendum, in the presence of the members of the NATRAX's Tender opening committee.

1.13.2. A letter of authorization shall be submitted to NATRAX, by the Bidder's representative before the opening of Bids.

1.13.3. Absence of bidders or their duly authorized representatives shall not impair the legality of the bid opening process.

1.13.4. All bidders or their duly authorized representatives shall be required to sign the main bid envelopes by way of confirmation of sealed bid status at the time of opening of bids.

1.13.5. After identification signing, the committee member/representative shall open the main bid envelope.

A. [TECHNICAL BID]

1.13.6. The technical bid envelope shall be then opened and the EMD shall be verified for specified value and validity. This will not give any right to the bidder to claim that he is successful in the bidding process. The Financial bid envelopes shall be required to sign by all the authorized representatives and the same will be kept under the custody of NATRAX. The technical Bids will be evaluated later to ensure that the bidder meets the minimum eligibility criteria as specified in the Instruction to the bidders (and NIT).

1.13.7. Refusal to sign on any of the bid envelopes by any of the bidder or his duly authorized representative may disqualify him from the process at the discretion of members of the tender opening committee present at the time of opening of the Bids.

1.13.8. The bids shall be declared to be 'Valid' or 'Invalid' at the conclusion of preliminary scrutiny process, at the discretion of the members of the tender opening committee present on the spot. The decision on declaring the bid is also subject to the submission of valid EMD of requisite amount and prima facie appearance of the bidding documents on totality.

1.13.9. Bids declared invalid shall be returned on the spot to the respective bidders. In case, the Bidder or it representative whose Bid has been declared invalid is not present at the time





of opening of the Bids, the Bid shall be returned to the Bidder duly intimating him to collect the same from NATRAX.

1.13.10. The conditional acceptance of any bid that does not meet the above preliminary acceptance criteria shall solely rest with NATRAX, in case of submission of substantially responsive bid in the opinion of NATRAX, supported with adequate documental evidence/cerfication of bidder in writting.

1.13.11. Refusal to any of the decision of NATRAX by any of the bidder or his duly authorized representative may disqualify him from the bidding process at the discretion of members of the tender opening committee present at the time of opening of the Bids.

1.13.12. Decision of NATRAX shall be final and No correspondence or claim whatsoever from such/any Bidders shall be entertained or responded by NAT

1.14. CLARIFICATIONS ON TECHNICAL BID EVALUATION

1.14.1. The technical bids shall be evaluated based on the available documents submitted by the bidder. To assist in the examination, evaluation and comparison of the bids, and qualification of the bidders, the Employer may, at its discretion, ask any bidder for a clarification of its bid. Any clarification submitted by a bidder that is not in response to a request by the Employer shall not be considered. The Employer's request for clarification and the response shall be in writing.

1.14.2. No change in the substance of the bid shall be sought, offered, or permitted and No additional/fresh information shall be sought by NATRAX, if considered/rectified, it would unfairly affect the competitive position of other bidders presenting substantially responsive bids.

1.14.3. If a bidder does not provide clarifications of its bid by the date and time set in the Employer's request for clarification, its bid may be rejected.

1.14.4. NATRAX also reserves right to seek confirmation/clarification from the issuer agency, on the supporting documents submitted by the bidder as per clause 3.2.1.

1.14.5. If the bidder is qualified in the technical bid evaluation and in case of omission of any documents in the bid, other than the documents as per clause 3.2.1, NATRAX may, at its discretion, ask the bidder in writting, to submit the same before opening of the financial bids, to consolidate their technical offer.

1.15. TECHNICAL BID EVALUATION (SEGREGATED TYPE)

1.15.1. NATRAX shall follow the **segregated bid evaluation system**, where the technical bids and the financial bids are evaluated separately, without integrating their merits in the technical/financial evaluation stages.

1.15.2. The technical bid evaluation is done based on the following criteria:

- (i) The responsiveness of the bid, i.e; receipts of duly filled, signed and accepted bid documents in complete, including addenda and Authorisation letter/Power of Attorney.
- (ii) Receipt of valid EMD with requisite amount in acceptable format.
- (iii) Documents in proof of meeting the minimum eligibility criteria.
- (iv) Any other documents as required to support the responsiveness of the bidder, as per tender.





1.15.3. A substantially responsive bid is one that meets the requirements of the Bidding Document without material deviation, reservation, or omission. A material deviation, reservation, or omission is one that, if accepted, it would affect in any substantial way, the scope, quality, or performance of the Works (specified in the Contract) or limit in any substantial way, inconsistent with the Bidding Document, the Employer's rights or the bidder's obligations under the proposed Contract.

1.15.4. During the evaluation of bids, the following definitions shall apply:

- (i) "Deviation" is a departure from the requirements specified in the Bidding Document;
- (ii) "Reservation" is the setting of limiting conditions or withholding from complete acceptance of the requirements specified in the Bidding Document; and
- (iii) "Omission" is the failure to submit part or all of the information or documentation required in the Bidding Document.

1.15.5. If a bid is not responsive to the requirements of the Bidding Document, it shall be rejected by the Employer and may not subsequently be made responsive by correction of the material deviation, reservation, or omission. No further evaluation of Technical Proposals will be carried out of those bidders whose Technical proposal is determined to be non-responsive and their Financial Proposals will be returned unopened.

1.15.6. The bidder, whose bid is found to be responsive in the evaluation stage, is only be considered as qualified and the result of the technical evaluation shall be **PASS/FAIL**.

1.15.7. The bidder who qualified in the technical evaluation stage shall only be called for opening of financial bids. NATRAX shall intimate the bidders, the time/ venue for the financial Bid opening in written communication.

1.16. FINANCIAL BID OPENING PROCEDURE

1.16.1. The Financial Bids of all the qualified Bidders shall be opened on the appointed date and time in presence of the qualified bidders/their authorized representatives, who choose to be present at the time of opening of the financial bids.

1.16.2. All the qualified bidders/their authorized representatives present at the time of opening of the Financial Bids shall be asked to sign on all the sealed envelopes containing the Financial Bid.

1.16.3. Any bidder objecting to the same shall be disqualified and his financial bid shall be returned on the spot.

1.16.4. Financial Bids of the qualified Bidders shall be opened in the presence of bidders or their authorized representatives.

1.16.5. Absence of bidders or their authorized representatives shall not legally impair the process.

1.16.6. The financial bid price, as indicated in the financial bid submission form of each bidder shall be read out on the spot, however, it shall be clearly stated that the final financial bid prices would be arrived at after detailed scrutiny/correction of arithmetical error in the financial bid.

1.16.7. Each qualified Bidder or their authorized representative shall be required to sign on the Bid price declaration sheet, against their respective price declared and also on the financial bid submission forms of all the bids. Any Bidder objecting to the same shall be disqualified.





1.16.8. Mere becoming the lowest bidder, prior to financial bid scrutiny will not give any right to the Lowest bidder to claim that he is successful in the bidding process.

1.17. FINANCIAL BID EVALUATION

1.17.1. The responsiveness of the bid shall be assessed based on the submission, on the latest financial format in case revised by addenda. For the evaluation of the Financial Bids, the eventual Bid prices shall be ascertained after considering all the terms and conditions associated with the Bid price specified in the Financial Bid document (such as unit, qty, rate and total) and after detailed scrutiny of the financial bid.

1.17.2. For evaluation of bid prices, NATRAX shall consider the item rate up to the fraction of 2 decimals only.

Procedure for Arithmetical correction

1.17.3. NATRAX reserves the right to include or exclude any component of the financial bid or the price quoted by the Bidder, and/or, load the bid price as per its discretion to bring the bids at a common platform and to ensure level playing of bids to work out the Bid Price for evaluation and comparison of bid prices.

1.17.4. If there is a discrepancy between the sub total/s and the total price that is obtained by multiplying the unit price and quantity/adding the sub total/s, the sub total/s shall prevail and the total price shall be corrected, unless in the opinion of the Employer that there is an obvious misplacement of the decimal point in the sub total price, in which case the total price as quoted shall govern and the sub total/s shall be corrected;

1.17.5. If there is an error in a total, corresponding to the addition or subtraction of sub totals, the subtotals shall prevail and the total shall be corrected; and

1.17.6. If there is a discrepancy between words and figures, the amount in words shall prevail, unless the amount expressed in words is related to an arithmetic error, in which case the amount in figures shall prevail subject to relevant clauses referred above.

1.17.7. The amount stated in the Letter of Bid will be adjusted by the Employer in accordance with the above procedure for the correction of errors and, shall be considered as binding upon the bidder. If the bidder does not accept the corrected amount of bid, its bid will be rejected, and the bid security shall be forfeited as per relevant clauses.

1.17.8. If a discount is offered in a financial proposal, such discount will be applied on prorata basis against each item of the financial form except the price part/s not considered for the "Total price for the package".

1.17.9. In case an additional component is loaded by the bidder on its bid price, after totaling the prices of schedules, such sum shall be applied on prorata basis on all the items to work out the item rates.

1.18. DETERMINATION OF THE SUCCESSFUL BIDDER

1.18.1. The Bidder meeting the minimum eligibility criteria with the lowest bid price, subject to arithmetical correction, shall be deemed as the successful Bidder.

1.18.2. In the event of more than one bidder with the lowest price bids (say equal), the bidder with the highest 'cumulative average turn over of the last 3 F.Ys' would be deemed as 'Successful Bidder' with respect to the submission of proof of documents as required by the client/submitted by the bidders.





1.19. CONTRACT NEGOTIATIONS

- 1.19.1. If the bid is seriously unbalanced, front loaded or substantially below updated cost estimates in the opinion of the Employer, the Employer may require the bidder to produce detailed price analyses for any or all items of the Bill of Quantities, to demonstrate the internal consistency of those prices with the construction methods and the works schedule proposed.
- 1.19.2. In such cases, Contract Negotiations shall be carried out with the successful bidder before the issue of Letter of Acceptance. In case the bid is front loaded as mentioned above, NATRAX shall negotiate the price and may accept if the bidder offers a discount as 'lump sum price' on total bid price/sub total or discount on specific item rates. No hike on the already quoted item rate shall be accepted during negotiation.
- 1.19.3. In case the contract negotiation is failed in the opinion of the NATRAX, NATRAX shall intimate the same to the bidder in writing and shall invite the second lowest bidder to negotiate the Contract. If this fails, NATRAX shall negotiate with the remaining responsive bidders in order of their relative ranking, subject to the right of the Employer to reject all the bids.
- 1.19.4. NATRAX does not undertake to accept the lowest or indeed any bid.
- 1.19.5. In case required by NATRAX, contract negotiations on other commercial terms and technical related Issues can also be done with the bidders, but no material deviation from the conditions of tender shall be sought or agreed.

1.20. NOTIFICATION OF AWARD BY ISSUANCE OF 'LETTER OF ACCEPTANCE'

- 1.20.1. Prior to the expiry of the period of Bid validity prescribed, NATRAX shall issue to the successful Bidder the "Letter of Acceptance" (LoA) in duplicate, who will return one copy to NATRAX duly acknowledged, accepted and signed by the authorized signatory, within **Three (3) days** of receipt of the same by him.
- 1.20.2. The issuance of the Letter of Acceptance to the bidder shall constitute an integral part and it will be a binding to the contract. Upon the issuance of the LoA, NATRAX shall encash/redeem/request to extend the EMD amount/validity, as per the conditions of contract.
- 1.20.3. The time taken between the date of issue of LoA and Notice to Proceed shall not prevent the contractor to mobilize the man power/equipments at site.

1.21. PERFORMANCE BANK GUARANTEE

- 1.21.1. The Successful Bidder within **Fifteen (15) days** of the acceptance of the LoA, shall execute a Performance Bank Guarantee as per contract, from a scheduled Bank, for an amount equivalent to the **5% of the accepted Contract Value**, which shall be kept valid for the entire period of work, i.e. till the completion of 30 days after the date of issue of the 'Defect rectification certificate'.
- 1.21.2. The Performance Bank Guarantee of the successful Bidder will be invoked and forfeited if he fails to comply with any of the conditions of contract.





1.22. ISSUANCE OF 'NOTICE TO PROCEED'

After the acceptance of the LoA and securing PBG from the successful bidder, NATRAX shall issue the 'Notice to proceed' (NTP), to the contractor authorising him to take possession of the allocated project site for pre-construction activities. Further 'NTP' shall be issued to the contractor along with relevant Technical inputs/GFC drawings/Fabrication drawings etc. to commence the construction activities. The time for completion of works as mentioned in the tender will be counted from this date issue of NTP. Refer clause 3 of the GCC for details.

1.22.1. NATRAX shall not entertain any claim, whatsoever, on account of time between the above two NTPs, if sought by the contractor.

1.23. SIGNING OF CONTRACT AGREEMENT

1.23.1. The successful Bidder shall enter into contract and shall execute and sign the Contract Agreement in accordance with the Articles of Agreement, within **Fifty (15) days** from the date of issue of letter of acceptance. But the written acceptance by NATRAX of a Bid will constitute a binding to Contract between NATRAX and the person so tendering, whether such formal agreement is not subsequently executed.

1.23.2. NATRAX shall prepare the draft Articles of Agreement in the Proforma included in this Document, duly incorporating all the terms of agreement between the two parties and send the same in duplicate to the successful Bidder for their concurrence within **Ten (10) days** of the date of receipt of the "Letter of Acceptance" duly acknowledged, accepted and signed by the successful Bidder.

1.23.3. The successful Bidder shall return the duly concurred copies of the draft Articles of Agreement within **Five (5) days** of receipt of the draft Articles of Agreement from NATRAX. Bidder shall prepare two copies of Articles of Agreement in a correct amount of stamp paper, duly adjudicated by the registrar of Stamps, of the State of Madhya Pradesh, where the contract agreement is proposed to be executed and the parties shall execute the contract agreement at the NATRAX, duly signed by the authorized signatories of both the parties. The authorised signature of the bidder shall be the same person who has signed on the bidding documents on behalf of the bidder, unless the change in the authorised person is notified by the Bidder in writing and a power of attorney is submitted by the bidder in this regard.

1.23.4. Further, the authorised person of NATRAX shall sign on all pages of the bidding documents submitted by the successful bidder and execute the complete set of contract agreement. One copy of the executed Articles of Agreement along with the complete set of contract documents shall be issued to the Contractor, within 10 days of execution of contract agreement.

1.24. RETURNING OF EARNEST MONEY DEPOSIT (BID SECURITY AMOUNT)

1.24.1. The Earnest Money Deposit of the unsuccessful bidders in the *technical Bid evaluation stage* shall be returned along with their un-opened financial bids within 7 days after opening of the eligible financial Bids.





- 1.24.2. The Earnest money Deposit of the unsuccessful bidders in the *financial bid evaluation stage* shall be returned within 7 days, on award of contract to the Successful bidder.
- 1.24.3. The Earnest money deposit of all the bidders shall be returned along with their unopened financial bids, in case of cancellation of Tender after the opening of Bids and prior to opening of financial bids
- 1.24.4. The Earnest money deposit of the Successful Bidder will be returned, upon the receipt of the PBG.

1.25. NATRAX's RIGHT TO ACCEPT /REJECT ANY OR ALL BIDDERS AND DIVIDE THE CONTRACTS

NATRAX reserves the right to accept / reject or modify any tender, and to annul the tender process and reject all tenders, at any time prior to award of Contract without assigning any reasons, or to divide the Contract between/amongst Bidders without thereby incurring any liability to the affected Bidder or Bidders or any obligations to inform the affected Bidder or Bidders of the grounds for NATRAX's action. The Bidders shall not have any cause of action or claim against NATRAX for rejection of their proposals.

1.26. PROCESS TO BE CONFIDENTIAL

- 1.26.1. Except the public opening of Bids, information relating to the examination, clarification, evaluation and comparison of bids and recommendations concerning the award of Contract shall not be disclosed to Bidders or other persons not officially concerned with such process.
- 1.26.2. Any effort by a Bidder to influence NATRAX or any of its functionaries in the process of examination, clarification, evaluation and comparison of tenders and in decisions concerning award of contract, may result in the rejection of the Bid.





Section-4- General Conditions of Contract [GCC]

NATIONAL AUTOMOTIVE TEST TRACKS

GENERAL CONDITIONS OF CONTRACT

**General Conditions of Contract(GCC) is available
in our website www.natrax.in**

**Please refer GCC before quoting tender and your
quoted rates shall be considered as per terms and
conditions of contracts mentioned in GCC**





Section- 5 - SPECIAL CONDITIONS OF CONTRACT [SCC]

5.1. The following clauses under this Special Conditions of Contract (SCC) complements to the corresponding clauses in the GCC. As per GCC, clause 1.5 (Priority of Documents), the SCC takes precedence over the GCC. Whenever there is a conflict, the provisions herein shall prevail over those in the GCC.

5.2. STATEMENTS TO COMPLEMENT THE GENERAL CONDITIONS OF CONTRACT

S. No	Conditions	Ref. to GCC	Statements
1	Amount of Recoverable advance Payments towards Mobilization of works/Materials.	1.1 & 26.11.1 26.11.2	Up to Ten (10) % of the Accepted Contract Price, with a simple interest rate of 10% per annum on the balance outstanding, against the BG of 110% of requisite advance amount, valid up to contract period/ up to recovery of full amount, whichever is earlier, shall be paid upon release of NTP and on request of the contractor. i.e. "The mobilization advance shall not be paid in less than two instalments" as decided by NATRAX representative on specific request by the contractor. On each occasion of the release of mobilization advance, Bank Guarantee equivalent to 110% of the advance so paid shall be furnished by the contractor for the period mentioned above.
2	The Default Interest Rate	1.1, 34.2	14% interest for the period, In case of non return of mobilization advance after stipulated due date.
3	The Defects Rectification Period, counted from the Date of completion of works (DoCW), as mentioned in the Completion certificate.	1.1	6 months
4	Guarantee Period for utility items (Counted from DoCW)	1.1	Deleted
5	Latent Defect Rectification Period , Counted from the next day after the date of Completion of Defects Rectification Period.	1.1	Deleted.



S. No	Conditions	Ref. to GCC	Statements
6	Liquidated Damages	1.1	0.1% of the final Contract Price per day. (Maximum up to 10 % of the Contract price)
7	Milestone Event	1.1	Deleted
8	Project site	1.1	National Automotive Test Tracks (NATRAX),NH-52, Old Agra- Mumbai Highway, Near to Pithampur Flyover, Post Khandwa (Near Pithampur) ,Dist. Dhar (M.P.)-454774
9	Provisional Sum	1.1	Nil
10	Provisional Sum Works	1.1	Nil
11	Time for Completion	1.1	02 (Two) Months from the date of issue of Notice to Proceed for complete work.
12	Address for Communication	1.4.1 (ii)	National Automotive Test Tracks (NATRAX) NH-52, Old Agra-Mumbai Highway, Near to Pithampur Flyover, Post Khandwa (Near Pithampur, Dist. Dhar (M.P.) Email:natraxpithampur@gmail.com
13	Amount of Performance Guarantee	1.9.1	5 % of the contract price.
14	Period of Performance Guarantee	1.9.1	Valid for 04 Months from the date of Issue of NTP
15	Date of return of the Performance Guarantee	1.9.6	The date within 30 days, after the date of issue of "Defect Rectification Certificate"
16	Percentage to be retained as Retention Amount	1.9.5	NA
17	Date of release of the Retention Amount	1.9.5 (ii)	NA
18	Property in excavated material	5.5, 13.7& 29.2	NA
19	Applicable Clearances that are NATRAX Responsibility	6.1.3 (iii)	<i>Only the statutory approvals in respect of NATRAX</i>
20	Claims	19A.1	No claims, including price variation etc. are permitted during the execution of works within the fixed completion period as mentioned in the Notice to proceed and also in the extended period in case the extension is granted.
22	Maximum Liquidated Damages	20.1	Maximum 10% of the final Contract Price.



S. No	Conditions	Ref. to GCC	Statements
23	Payment of Bonus	20.4	Nil
24	Variation of quantities	22.2.2 (ii) 23.4	<p>This tender is based upon the drawings enclosed with technical specifications and BOQ. NATRAX reserves the right to vary any individual item to any extent either positive or negative within the scope of work as defined. The decision as to items are within the scope of work shall be of NATRAX which is final & binding.</p> <p>Therefore, in case of variation in quantity as given in BOQ either positive or negative no rate revision is applicable.</p>
25	Contractor's Changes	23.3.3	Nil
26	Valuation of Changes	23.5.1 (1)	New Rate or Price shall be derived from any relevant rates or prices in the Contract.
		23.5.1 (2)	<p>New rate or price shall be derived from the MP SOR for building work 2024 & latest MPSOR for Road & Bridges rates and MPSOR 2022 for Electrical Works(E&M) which ever applicable. In case the rates are not available in MP SOR for building work 2024 & latest MPSOR for Road & Bridges rates and MPSOR 2022 for Electrical Works(E&M) rates, the same shall be derived from the competitive market quotes, obtained by NATRAX representative.</p> <p>The contractor's profit and overheads together shall be taken as 10% only.</p>
		23.5.1 (3)	Rates or prices shall be those in the Contract of that particular omitted item of work.
27	Payment against materials stored at site.	26.3.3(ii)	Can be considered only against the actual cost of material as per invoice.
28	Mode of Payment	26.7	<i>Through RTGS/NEFT</i>
29	Currency of Payment	26.9	Indian Rupees Only.
30	Repayment of Recoverable advance amount towards Mobilization of works.	26.11.6	Repayment of Advance amount towards mobilization shall be made in 3 equal instalments, by way of A/c. Payee cheque/DD, payable at Pithampur, in favour of 'National Automotive Test Tracks' or by way of deduction from IPC as opted by contractor.





S. No	Conditions	Ref. to GCC	Statements
31	Taxes	27.1	The rates quoted by the contractor shall be deemed to be inclusive of the Goods and Service Tax (GST) and other levies, duties, royalties, cess, tax, toll taxes of central and state governments, local bodies and authorities that the contractor will have to pay for the performance of this contract. NATRAX will perform such duties in regard to the deduction of such taxes at source as per applicable law. The tax if any paid by the contractor shall not be reimbursed by NATRAX. And change in legislation will not applicable for reimbursement of tax.

Important note: Wherever the word NATRIP/NATIS appears in this document may please be read as NAB/NATRAX.





SECTION-5.1-Milestones

Deleted

Section- 6.1- FORMAT OF ARTICLES OF AGREEMENT

**CONTRACT AGREEMENT No.: Tender No. _____ , Dated-----
.....the 2026**

THIS AGREEMENT is made on between **National Automotive Test Tracks (NATRAX)**, a Unit of **National Automotive Board Society** having its registered office at 124, Udyog Bhawan, New Delhi - 110001 (hereinafter referred to as “the Employer” which expression shall include its successors and assigns), and whose principal place of business is at National Automotive Test Tracks (NATRAX), NH-52, Old Agra-Mumbai Highway, Near to Pithampur Flyover, Post Khandwa (Near Pithampur),Dist. Dhar (M.P.)-454774 , of the One Part,

AND

M/s., having its registered office at, (Hereinafter referred to as “the Contractor”), of the Other Part:

WHEREAS the Employer invited bids through open tender, vide Invitation for Bids dated, 24th April 2026 “**Supply and Spreading of dust sand and related work in Dust Tunnel Building at T-5 Track” at NATRAX- Pithampur” Dhar District, Madhya Pradesh**”(Supply and spreading of 125micron dust sand and related work in Dust Tunnel Building at T-5 Track)- **under Tender No: Tender No:NATRAX/PROC/PG-C&M/26/143**

AND WHEREAS the Employer has selected, as the successful bidder (“the Contractor”) pursuant to the bidding process and negotiation of contract prices, awarded the **Letter of Acceptance (LOA) No.**, to the Contractor on for a total sum of [Rupees Only].

- I. **AND WHEREAS** the Employer desires that the Works (as defined in the Bidding Document) be implemented, performed, executed and completed by the Contractor, including the remedying of any defects therein and wishes to appoint the Contractor for carrying out such Works.
- II. **AND WHEREAS** the Contractor acknowledges that the Employer has entered into or will enter into other contracts with other contractors and/or parties for elements of the Project (as defined in the General Conditions of Contract) (and not comprised in the Works) and that the Employer will have Related Works performed and that it is of paramount importance that the Works are fully and completely co-ordinated by the contractor with the Related Works in view of their concurrent and sequential nature.
- III. **AND WHEREAS** the terms and conditions of this Contract have been fully negotiated between the Employer and the Contractor as parties of competent capacity and equal standing.
- IV. The Employer and the Contractor agree as follows:

In this Agreement (including the recitals) capitalized words and expressions shall have the same meanings as are respectively assigned to them in the Contract documents referred to.





2. The following documents shall be deemed to form and be read and construed as part of this Agreement. This Agreement shall prevail over all other Contract documents.

The Letter of Acceptance (LoA) issued by NATRAX.

The complete Bid as submitted by the Contractor.

The Addenda issued by NATRAX.

Any other documents forming part of this Contract Agreement till date. (PBG, BGs, PoA etc.)

The negotiated Bill of Quantities.

Supplementary Agreements executed from time to time.

3. Any changes/modifications/amendments required to be incorporated in the Contract Agreement at a later stage shall be discussed and mutually agreed by both the parties and such supplementary agreements shall be binding on both the parties and shall form the part of this contract agreement.
4. The key personnel earmarked for this Project from NATRAX and Project Management Consultants shall be intimated to the contractor from time to time. The key personnel to be deployed for the project from the Contractor's side shall be decided and mutually agreed from time to time.
5. The contractor's submissions under clause 3.3 (c) of the General Conditions of Contract, 'the Initial Program', shall be further detailed and a realistic 'Detailed Work Schedule' shall be prepared, complying to the 'time for completion', as specified in the Special Conditions of Contract and submitted to the Employer, within 21 days from the date of issue of the relevant 'Notice to Proceed' and the said Detailed Work Schedule shall be discussed and mutually agreed by both the parties, within 30 days from the date of issue of the relevant 'Notice to Proceed', to be issued for the works.
6. In consideration of the payments to be made by the Employer to the Contractor as indicated in this Agreement, the Contractor hereby covenants with the Employer to execute the Works and to remedy defects therein in conformity, in all respects with the provisions of the Contract.
7. The Employer hereby covenants to pay the Contractor in consideration of the execution and completion of the Works and the remedying of defects therein, the Contract Price or such other sum as may become payable under the provisions of the Contract at the times and in the manner prescribed by the Contract.
8. This Contract shall be governed by and construed in accordance with the laws of India. Each Party hereby submits to the jurisdiction as set out in the Dispute Resolution Procedure in the Conditions of Contract.

V. IN WITNESS WHEREOF the parties hereto have caused this Agreement to be executed in accordance with the laws of India on the day, month and year indicated above.

For and in the name of NATRAX under NATRIP
acting through and represented by Sh.
..... (.....)

For and in the name of the M/s.
acting through and represented by
Sh.





(Signature)	(Signature)
Witnessed by: Sh.)/NATRAX	Witnessed by : Sh., M/s.....
(Signature)	(Signature)





Section 6.2- Form of Sub contractor's Warranty -Deleted.

SECTION 6.3- PERFORMANCE BANK GUARANTEE

(TO BE EXECUTED ON NON-JUDICIAL STAMPED PAPER OF AN APPROPRIATE VALUE)

National Automotive Test Tracks (NATRAX),
NH-52, Old Agra- Mumbai Highway,
Near to Pithampur Flyover,
Post Khandwa (Near Pithampur),
Dist. Dhar (M.P.)-454774

Date :

Bank Guarantee No :
Amount of Guarantee :
Guarantee Period : From to.....
Guarantee Expiry Date :
Last date of Lodgement :

WHEREAS National Automotive Test Tracks (NATRAX), having its corporate office at NBCC Place, 3rd Floor, South Tower, Bhishma Pitamah Marg, Pragati Vihar, Lodhi Road, New Delhi-110003 and site office at NH-52, Old Agra- Mumbai Highway, Near to Pithampur Flyover, Post Khandwa (Near Pithampur), Dist. Dhar (M.P.)-454774. **"The Owner"** which expression shall unless repugnant to the context includes their legal representatives, successors and assigns) and having their registered office at 124, Udyog Bhawan, New Delhi - 110011, has executed a binding to the contract on [*Please insert date of acceptance of the letter of acceptance(LoA)*] (**"Contract"**) with [*insert name of the Successful Bidder*](hereinafter referred to as the **"Contractor"** which expression shall unless repugnant to the context include its legal representatives, successors and permitted assigns) for the performance, execution and implementation of the Works (**"Works"** shall have the meaning ascribed to it in the Contract] based on the terms & conditions set out in the Tender Documents number [*insert reference number of the Tender Documents*] dated [*insert date of issue of Tender Documents*].....and various other documents forming part thereof.

AND WHEREAS one of the conditions of the Contract is that the Contractor shall furnish to the Owner a Bank Guarantee from a scheduled bank in India having a branch at Pithampur for an amount equal to 5% (five percent) of the total Contract Sum (the amount guaranteed under this bank guarantee shall hereinafter be referred to as the **"Guaranteed Amount"**) against due and faithful performance of the Contract from the post-commissioning stage of the Works under the Contract, including the performance bank guarantee obligation and other obligations of the Contractor for the supplies made and the Works being performed and executed by under the Contract. This bank guarantee shall be valid from the date hereof up to the expiry of the Warranty Period including any extension thereof.

AND WHEREAS the Contractor has approached [*insert the name of the scheduled bank*] (here in after referred to as the **"Bank"**) having its registered office at [*insert the address*].....and at the request of the Contractor and in consideration of the promises made by the Contractor, the Bank has agreed to give such guarantee as hereunder:-





- (i) The Bank hereby undertakes to pay under this guarantee, the Guaranteed Amount claimed by the Owner without any further proof or conditions and without demur, reservation, contest, recourse or protest and without any enquiry or notification to the Contractor merely on a demand in the form set out in Appendix I (“**Demand**”) from the Owner stating that the amount claimed is due to the Owner under the Contract. Any such demand made on the Bank by the Owner shall be conclusive as regards the amount due and payable by the Bank under this bank guarantee and the Bank shall pay without any deductions or set-offs or counterclaims whatsoever, the total sum claimed by the Owner in such Demand. The Owner shall have the right to make an unlimited number of Demands under this bank guarantee provided that the aggregate of all sums paid to the Owner by the Bank under this bank guarantee shall not exceed the Guaranteed Amount. In each case of demand, resulting to change of PBG values, the Owner shall surrender the current PBG to the bank for amendment in price.
- (ii) However, the Bank’s liability under this bank guarantee shall be restricted to an amount not exceeding [figure of Guaranteed Amount to be inserted here].....
...only).
- (iii) The Owner will have the full liberty without reference to the Bank and without affecting the bank guarantee to postpone for any time or from time to time the exercise of any powers and rights conferred on the Owner under the Contract and to enforce or to forbear endorsing any powers or rights or by reasons of time being given to the Contractor which under law relating the Surety would but for the provisions have the effect of releasing the surety.
- (iv) The rights of the Owner to recover the Guaranteed Amount from the Bank in the manner aforesaid will not be affected or suspended by reasons of the fact that any dispute or disputes have been raised by the Contractor and / or that any dispute(s) are pending before any office, tribunal or court in respect of such Guaranteed Amount and/ or the Contract.
- (v) The guarantee herein contained shall not be affected by the liquidation or winding up, dissolution, change of constitution or insolvency of the Contractor but shall in all respects and for all purposes be binding and operative until payment of all money due to the Owner in respect of such liability or liabilities is effected.
- (vi) This bank guarantee shall be governed by and construed in accordance with the laws of the Republic of India and the parties to this bank guarantee hereby submit to the jurisdiction of the Courts of Madhya Pradesh for the purposes of settling any disputes or differences which may arise out of or in connection with this bank guarantee and for the purposes of enforcement under this bank guarantee.
- (vii) All capitalized words used but not defined herein shall have the meanings assigned to them under the Contract.
- (viii) NOTWITHSTANDING anything stated above, the liability of the Bank under this bank guarantee is restricted to the Guaranteed Amount and this bank guarantee shall expire on the expiry of the Warranty Period under the Contract.**
- (ix) Unless a Demand under this bank guarantee is filed against the Bank within six (6) months from the date of expiry of this bank guarantee all the rights of the Owner under this bank guarantee shall be forfeited and the Bank shall be relieved and discharged from all liabilities hereunder.

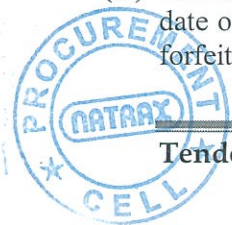



- (x) However, in the opinion of NATRAX, if the Contractor's obligations against which this bank guarantee is given are not completed or fully performed by the Contractor within the period prescribed under the Contract, on request of the Contractor, the Bank hereby agrees to further extend the bank guarantee, till the Contractor fulfils its obligations under the Contract.
- (xi) We have the power to issue this bank guarantee in your favour under Memorandum and Article of Association and the Undersigned has full power to do so under the Power of Attorney dated [*date of power of attorney to be inserted*]......granted to him by the Bank.

Date:

Bank

Corporate Seal of the Bank

By its constituted Attorney Signature of a person duly authorized to sign on behalf of the Bank.





Appendix-I

FORM OF DEMAND

[To the issuing Bank]

Dear Sirs

The Contract between National Automotive Test Tracks (NATRAX) and [*Please insert the name of the Successful Bidder*]

Bank Guarantee No. ***** (“the Bank Guarantee”)

We refer to the above Contract and Bank Guarantee. Terms defined in the Bank Guarantee shall have the same meaning when used herein.

In accordance with the terms of the Bank Guarantee, we require payment by you of the sum of Rs. [*****] (***) Rupees) to the following account:

Account Number: [] with [] Bank, [] Branch, Sort Code [].

Yours sincerely,

[Signed by
[]
for and on behalf of
NATRAX





Section 7.1- FORM FOR FINANCIAL CAPACITY

FINANCIAL DATA IN INR

*Financial Capacity: Should have the Averagl Financial turnover of at least **Rs.12 Lakhs.** in the last 3 financial years ((2022-23, 2023-24, 2024-25),). Relevant proof for supporting the above shall be submitted or certificate from CA will be require..*

Financial Years	2022-2023	2023-2024	2024-2025
Financial Turnover			

Section 7.2- List of Equipment (Minimum Requirement as and when required)

1) Whereas it is entirely the responsibility of the Contractor to deploy sufficient machineries and mechanical equipment to ensure compliance with his obligations under the Contract, the list hereunder is included for information. This list constitutes the Employer's estimate of the minimum essential basic holding of plant and mechanical equipment which the Contractor will require in order to meet all of his performance obligations under this Contract.

S. No.	Name/Type of Equipment	Max. age (in Years)	Nos.
1	Manual Weigh Batcher	7-8	01
2	Mixer machine	7-8	01
3	Tractor	7-8	01
4	Tractor mounted Pile drilling Machine	5-7	01
5	Welding/ drilling machine	5-7	01
6	Tools & Tackles for fitting of accessory	5-7	01





Section 7.3 PERSONAL CAPABILITIES :

1) The Bidder shall supply general information on the management structure of the firm and shall make provision for suitably qualified personnel to fill the key positions as required during contract implementation and as suggested in Section.

MINIMUM KEY PERSONNEL FOR THE PROJECT

Whereas it is entirely the responsibility of the contractor to deploy sufficient Key Personnel at his office and at the site to ensure compliance with his obligations under the Contract. The list hereunder constitutes the Employer's assessment of minimum key site personnel requirements and is issued for information only.

S.No.	Personnel	Qualification/ Experience	Nos.
1	Site Engineer	Diploma in Civil Engineering 5 years Exp.	01
2	Site Supervisor	Experience in Civil Engineering work with + 3 years Exp.	01

Section 7.4- FORM FOR TECHNICAL CAPABILITY

(Refer the Minimum Eligibility Criteria at 2 (iii) of the ITB)

Here the Bidder shall fill the details of the "Supply and Spreading of dust sand and related work in Dust Tunnel Building at T-5 Track" at NATRAX-Pithampur- Dhar District, Madhya Pradesh.

Bidder should have successfully completed *similar works component during the last Seven(7) years pertaining to any of the following criteria:

- Three similar completed works, costing not less than the amount equal to 40% of the estimated cost of each work.
(OR)
- Two similar completed works, costing not less than the amount equal to 50% of the estimated cost of each work.
(OR)
- One similar completed works costing, not less than the amount equal to 80% of the estimated cost.

For the purpose of assessment of technical capability, the latest cutoff date of work is 30 days prior to last date of submission of Bid Document.

***Similar work:** Successfully Completed works pertaining to Civil Construction/ Civil Maintenance work for road/Track work for any Automobile Test Tracks/Proving Ground/Express way/National High way/State High way in any Central Govt/State Govt/Public Sector Undertaking/Reputed Firms.

Copy of Valid LOA/Agreement/work order & Completion Certificate.





Section 8- CONTACT DETAILS FORM

BIDDERS ARE REQUESTED TO SUBMIT THE FOLLOWING DETAILS WITHIN 7 DAYS FROM THE DATE OF PURCHASE OF TENDER DOCUMENTS

[THE SIGNED DOCUMENT MAY BE SCANNED/FAXED]

**“Supply and Spreading of dust sand and related work in Dust Tunnel Building at T-5 Track”
at NATRAX-Pithampur- Dhar District, Madhya Pradesh. Under Tender
No:NATRAX/PROC/PG-C&M/26/143**

GENERAL DETAILS OF BIDDER

- 1. NAME OF THE COMPANY :
- 2. COMMUNICATION ADDRESS :
- 3. PHONE NO. :.....:
- 4. FAX NO. :.....
- 5. E-Mail ID. :.....

PARTICULAR DETAILS OF THE BIDDER’S REPRESENTATIVE

- 6. NAME OF THE CONTACT PERSON
- 7. DESIGNATION :.....
- 8. PHONE NO. (DIRECT) :.....
- 9. MOBILE NO. :.....
- 10. E-MAIL ID :.....
- 11. NAME OF THE ALTERNATE
CONTACT PERSON :.....
- 12. E-MAIL ID :.....

**Signature of the
Authorized Signatory**

NOTE: You are requested to check the E-mail IDs given by you regularly for the incoming mails form NATIS.





Section-9- Checklist

Sl. No	GENERAL	YES/NO
1	Have you send the contact details form to NATRAX?	
2	Have you read and understood various conditions of contracts like ITB,GCC, SCC,TCC (Technical specifications, drawings) and all other contractual requirements ?	
	TECHNICAL BID	
3	Have you enclosed the EMD for Rs. 14,000/- in the technical Bid?	
4	Have you taken prints of all the sections of tender, including addenda, in the prescribed paper size and signed on all the pages of the tender documents?	
5	Have you attached proof for having met the following minimum eligibility criteria?	
5.1	<i>legally valid entity: Certificates issued by registrar of firms/companies</i>	
5.2	<i>Financial Capacity of last 3 financial years</i>	
5.3	<i>Technical Capability: Certificates issued by govt. Depts/ Autonomous bodies/ PSUs/Reputed Private Firms (only). TDS certificate/C.A's certificate in case required</i>	
6	Have you attached the proof of authorisation to sign on behalf of the bidder _____ in _____ the technical Bid?	
7	Have your technical bid been prepared for packing as per Tender?	
	FINANCIAL BID	
8	Have your financial Bid proposal is duly filled, sealed and signed on all pages?	
9	Have you filled your quotes against all items?	
10	Have you verified the calculation of prices?	
11	Have your financial bid been properly packed as per Tender?	





NATIONAL AUTOMOTIVE TEST TRACKS

TENDER DOCUMENTS

“Supply and Spreading of dust sand and related work in Dust Tunnel Building at T-5 Track at NATRAX-Pithampur”(Supply and spreading of 125micron dust sand and related work in Dust Tunnel Building at T-5 Track)

Tender No: NATRAX/PROC/PG-C&M/26/143

Cover Page- Technical Conditions of Contract (TCC)

The Technical Conditions of Contract contains the following Sections:

Section 10.1	-	Technical Specifications Civil Works
Section 10.2	-	Technical Specifications Electrical Works-Nil
Section 10.3	-	Technical Specifications Plumbing Work-Nil
Section 11	-	Drawings
Section 12	-	Forms for Technical & Commercial Queries

National Automotive Test Tracks (NATRAX)

NH-52, Old Agra- Mumbai Highway, Near to Pithampur Flyover, Post Khandwa (Near Pithampur)

Dhar District, Madhya Pradesh-454774

Phone: +919893892310, Fax – 07292-256101

Email:natraxpithampur@gmail.com or a.prabhakar@natrax.in





10.10 TECHNICAL SPECIFICATIONS

“Supplying and Spreading dust sand and related works in Dust Tunnel Building at T-5 NATRAX, Pithampur, Dhar (M.P.)”(Supplying and spreading of 125micron dust sand and related work in Dust Tunnel building work at T-5 Track)

Preamble

1. The General Technical Specifications for the construction of the works shall be **Specifications for Road and Bridge Works (Fifth Revision) of Ministry of Road Transport & Highways, published by the Indian Roads Congress (herein after called MORTH Specifications)**. This part deemed to be bound into this document.
2. The Technical Specifications shall be read in conjunction with the other Sections of the bid documents as specified in Instruction to Bidders and other related documents
3. In case of any conflict on unit of measurement and payment in this specification and that in the BOQ, the unit in BOQ shall prevail.
4. The quantity provided in BoQ derived from the scheme drawings provided with tender Document, the work shall be executed as per approved GFCD'S only which will be submitted by contractor based on input provided in the tender documents.
5. The work in general shall be carried out as per Specifications for Ministry of Road Transport & Highways (MoRTH) Specifications for Road and Bridge Works ((Fifth Revision) and its latest amendments for which specification are not included in the specification, all such works in general shall be carried out as per latest (MoRTH) Specifications as describe below: -

I) The work in general shall be carried out as per latest (MoRTH) Specifications (updated with correction slips issued up to last date of submission of tender) unless otherwise specified in the nomenclature of the individual item or in the particular specifications for civil works and CPWD specification, and latest or 1994 for electrical work updated with correction slips issued Upto last date of submission of tender.

II) For items not covered under “(MoRTH) Specifications (Civil Works)/ latest CPWD specification”, the work shall be done as per latest relevant IS Codes of Practice. In any particular matter if (MoRTH) specifications and IS specifications both are silent than any other relevant codes of practice like ASTM/AASTHO /DIN may be referred.

6. In the absence of any definite provisions on any particular issue in the aforesaid Specifications, reference may be made to the latest BIS codes and specifications of





BIS, BS, ASTM or AASHTO in that order. Where even these are silent, the construction and completion of the works shall conform to sound engineering practice as approved by the Engineer in charge and in case of any dispute arising out of the interpretation of the above, the decision of the Engineer-in-charge shall be final and binding on the Contractor.

7. Whenever reference is made in the Contract to specific standards and codes to be met by the goods and materials to be furnished, and work performed or tested, the provisions of the latest current edition or revision of the relevant standards and codes in effect shall apply, unless otherwise expressly stated in the Contract. Where such standards and codes are national, or relate to a particular country or region, other authoritative standards which ensure an equal or higher quality than the standards and codes specified will be accepted subject to the Engineer's prior review and written approval. Differences between the standards specified and the proposed alternative standards must be fully described in writing by the Contractor and submitted to the Engineer's at least 28 days prior to the date when the Contractor desires the Engineer's approval. In the event the Engineer determines that such proposed deviations do not ensure equal or higher quality, the Contractor shall comply with the standards specified in the documents.

PART-A TECHNICAL SPECIFICATION

SECTION-200 SITE CLEARANCE

SECTION 300: EARTHWORK, EROSION CONTROL AND DRAINAGE-

SECTION 400: SUB-BASES, BASES (NON-BITUMINOUS) & SHOULDERS

SECTION 1700: STRUCTURAL CONCRETE

NOTE- ANY OTHER RELEVANT MORTH SPECIFICATION APPLICABLE TO BE FOLLOWED DURING EXECUTION OF WORK.





Section 10.2&10.30 Technical Specifications-Electrical and Plumbing works-Nil

Section 11 – Drawings:

Cross Section for Dust Tunnel

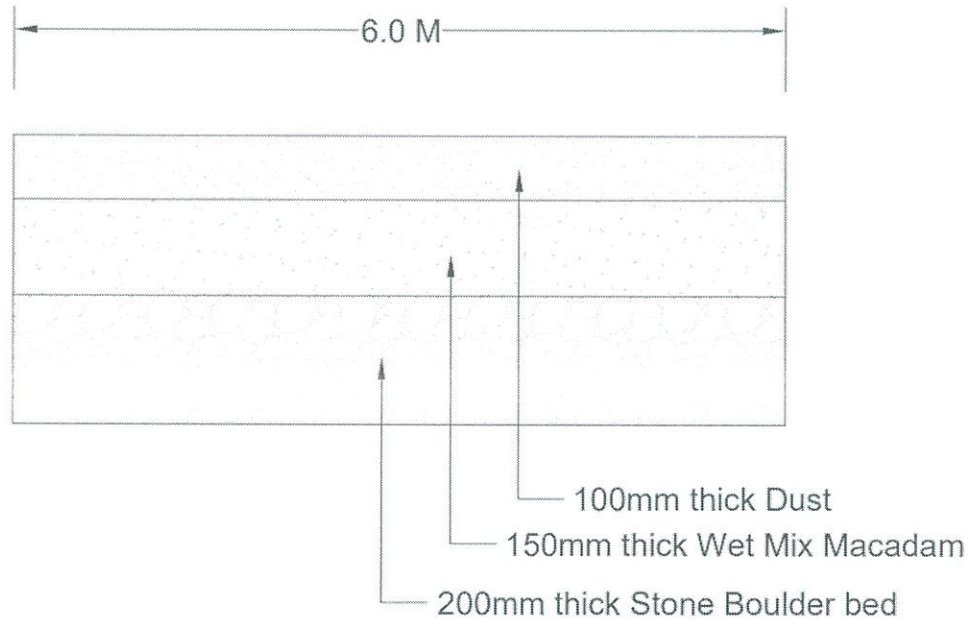



SECTION 13- FINANCIAL PROPOSAL SUBMISSION FORM

(To be Executed on Letterhead of the Bidder)

FINANCIAL PROPOSAL SUBMISSION FORM

[Location, Date]

To: The Head- Procurement & stores
National Automotive Test Tracks (NATRAX),
NH-52, Old Agra- Mumbai Highway,
Near to Pithampur Flyover,
Post Khandwa (Near Pithampur),
Dist. Dhar (M.P.)-454774

Dear Sir,

We, the undersigned, offer to provide the contract services in accordance with your Tender No. -----
----- and our Technical Bid, dated.....

Our attached Financial Bid includes the price in the format for financial bid provided (BOQ) as part of tender documents. The **total price of our offer** is INR _____ (in figures and words) and includes all the deliverables under this tender as per our Technical Bid.

The above total bid price includes a price discount/rebate (if any) of% (in figures and words) OR INR.....(in figures and words).

We hereby declare that all the information and statements made in this Bid is true and complete in all respects and is as per the guidelines and terms & conditions laid down in the tender document. We further understand that our financial bid is subject to scrutiny/arithmetical checks and any information which is found false or is not as per the guidelines and terms & conditions of the tender document may lead to our disqualification.

Our Financial Bid shall be binding upon us subject to the modifications resulting from Contract negotiations, up to expiration of the validity period of the Bid.

We understand NATIS has right to accept or reject our Bid or split the works among the bidders for the purpose of award, as per its discretion.

Yours sincerely,

Authorized Signature [In full]: _____

Authorized Signature [In initials]: _____

Name and Title of Signatory: _____

Name of Firm: _____

Address: _____

[Note : To be signed in blue ink]





Name of the work: Supply and Spreading of Dust Sand and related work in dust Tunnel Building at T-5 Track at NATRAX-Pithampur-Dhar-Madhya Pradesh(Supplying and spreading of 125micron Dust Sand and related work in Dust Tunnel Building at T-5 Track).

Section 14 Bill of Quantities (BOQ)(Item Rate to be Quoted)

S. No	DSR Code	Description of Item	Unit	Quantity	Rate Rs.in Fig (incl. GST and all)	Rate Rs. in WORDS GST and all)	Amount Rs. (Inclusive of GST and all)
1	2.6.1/P-87	Earth work in excavation/Removal by mechanical means(Hydraulic Excavator) Manual means over area (30cm in depth,Exceeding 1.5 M in width as well as 10 Sqm in plan) including getting out and Disposal of excavated earth lead upto 50m and for all lift ,as Directed by Engineer-In-Charge.	CuM	144.00			
2	23.5/P-308	Supplying,Filling,Spreading,laying and Leveling of Gravels/Stone Boulders pf size range 50mm to 200mm in the bed in required thickness,for all leads & lift,all complete as per Direction of engineer-In-Charge.	CuM	144.00			
3	16.79/P-238	Providing, Laying,Spreading and Compacting graded stone aggregate(Size:53mm to 0.075 mm) to wet mix mecadam(WMM) specification including premix the materials with water at OMC in for all lead & lifts,Laying in uniform layer with mechanical means and compacting with vibratory roller of 8 to 10 tonne capacity to achieve desired density,Complete as per Specification and direction of Engineer-In-Charge.	CuM	108.00			

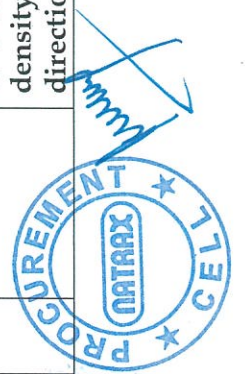



S. No	DSR Code	Description of Item	Unit	Quantity	Rate Rs.in Fig (incl. GST and all)	Rate Rs. in WORDS GST and all)	Amount Rs. (Inclusive of GST and all)
4	4.1.2/P-96	Providing and Laying Plain/Reinforced Cement Concrete in position cement concrete of specified grade excluding cost of centering and shuttering -All work upto plinth level, M20 Grade,1:1.5:3(1Cement:1.5Coarse Sand :3Coarse aggregate 20mm Nominal Size)	CuM	2.70			
5	4.3.1/P-98	Centering and Shuttering Including Strutting, Propping etc. and Removal of formwork for: Foundation, Footings, Bases for Column	SqM.	0.90			
6	1159/P-16	Supplying & laying of 125Micron dust sand over a prepared WMM bed conforming to IS sieve in dust tunnel building.	CuM	72.00			
Total amount Rs(including GST)							

SEAL & SIGN OF BIDDER

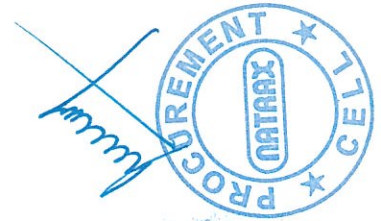



Steps for loading passwords in PDF Files-Method I

Step 1- please open PDF file and click on "Advance" tab.

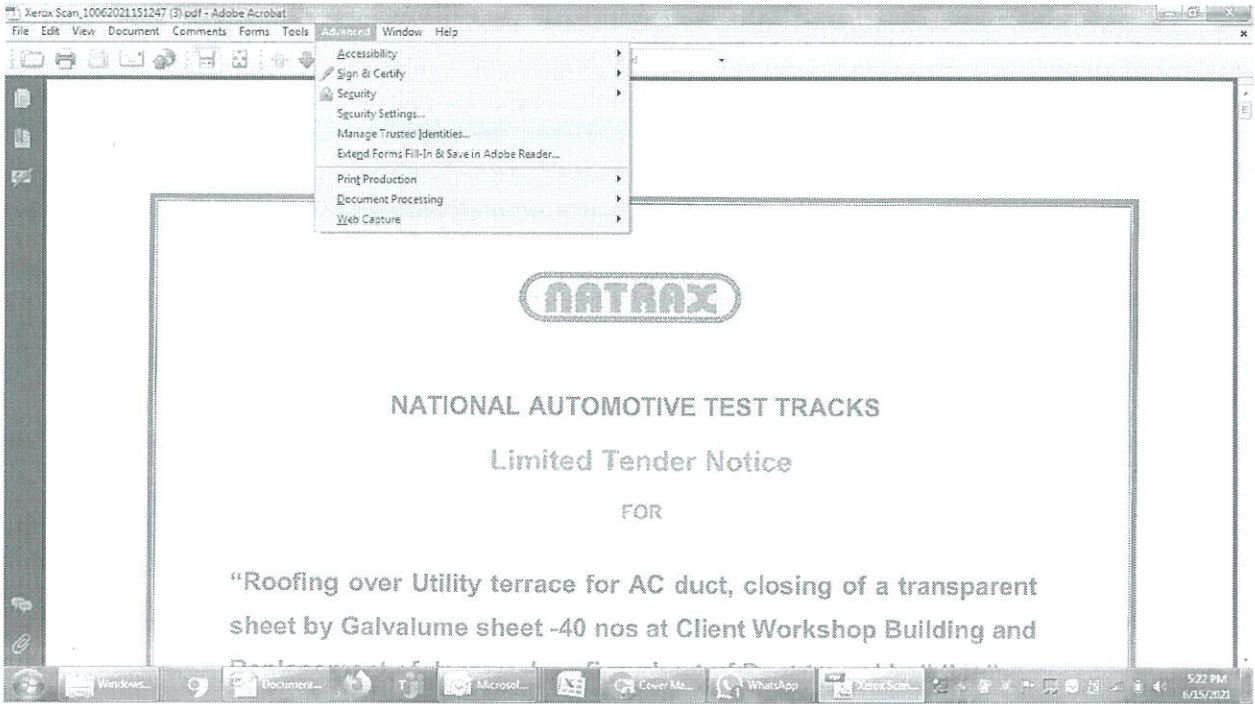

Step 2- in the advance tab, please click on the "Security" tab.

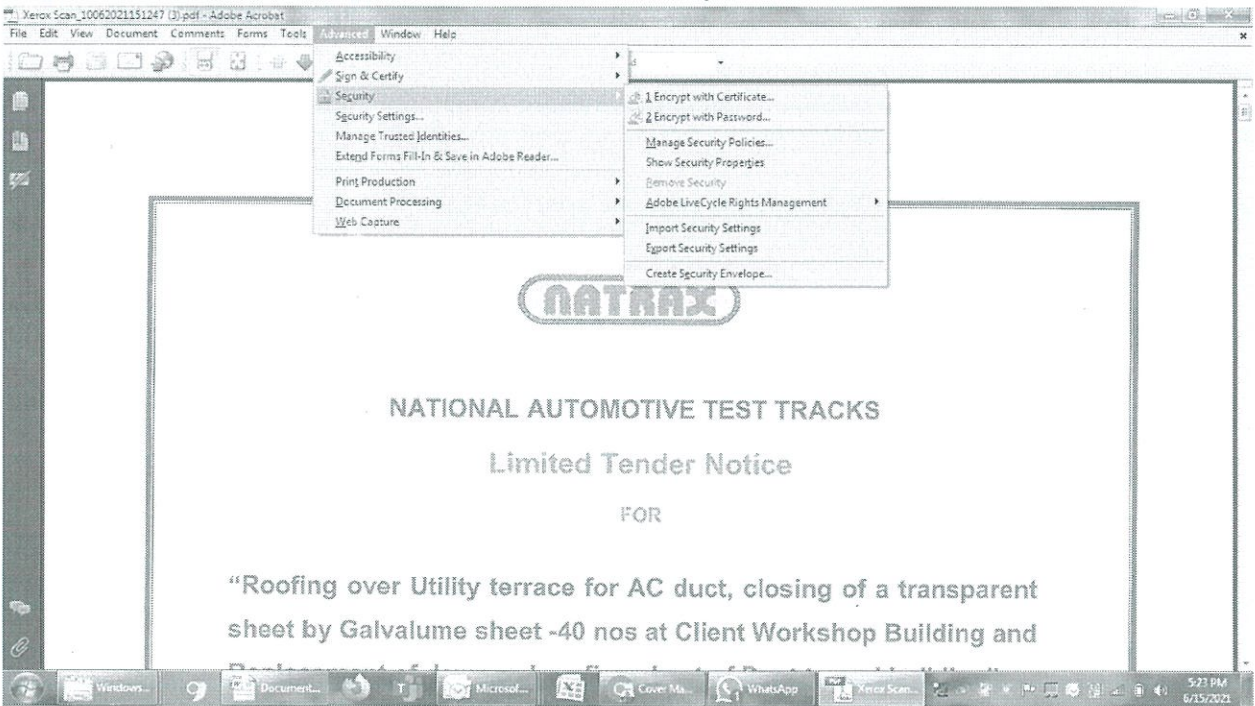



Step 3- in security tab, please click on "2 Encrypt with Password".

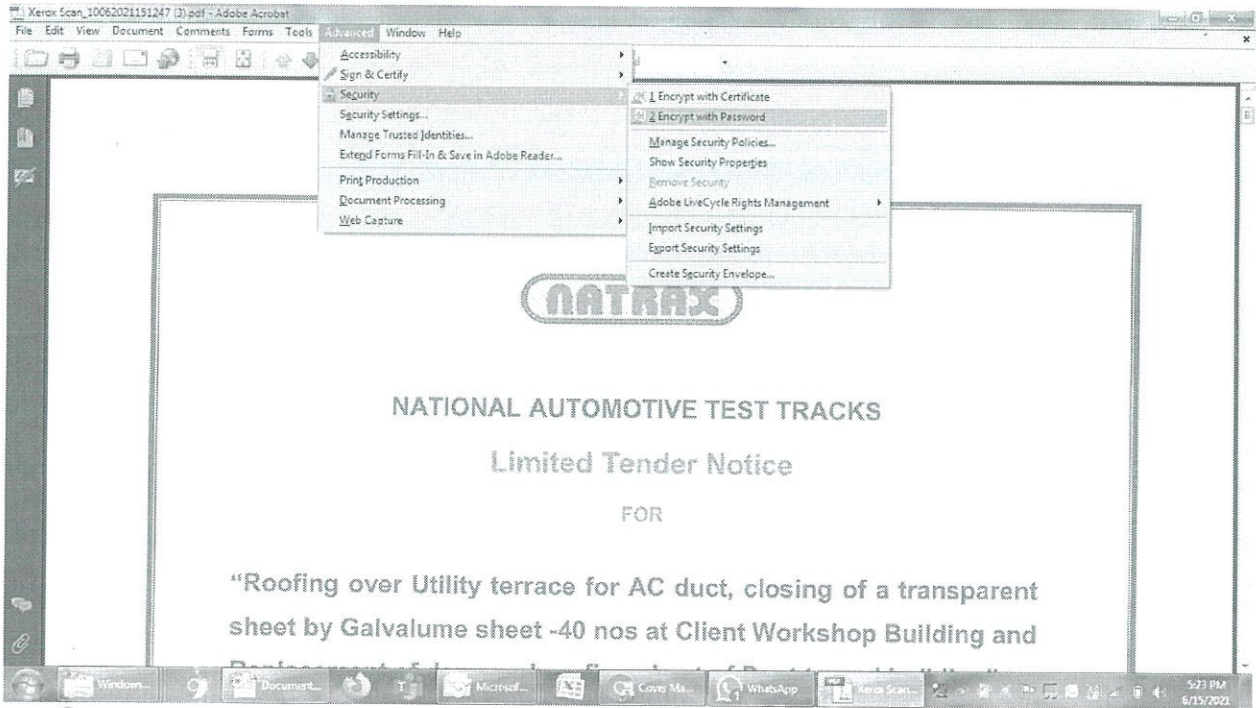

Step 4- after that below window will open, please check in option "Required a password to open the document". Then please fill password and click "ok".

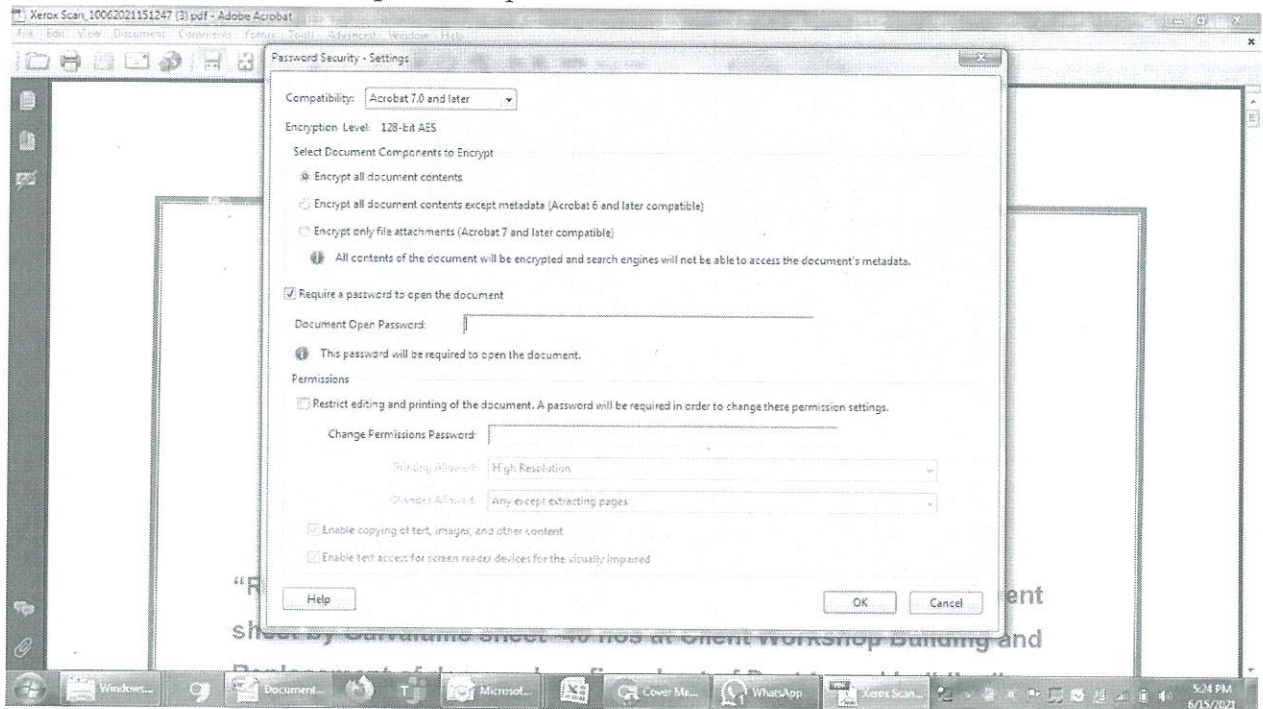

Step 5- after that below window will be open, please fill same password again, and click "ok".

