



NATIONAL AUTOMOTIVE TEST TRACKS

TENDER DOCUMENTS FOR

**"Providing/Casting RCC Dead Load Block (DLB) for  
Testing Laden Vehicle (LCV & HCV)" at NATRAX-  
Pithampur"**

Tender No. NATRAX/PROC/PG-C&M/26/135.



National Automotive Test Tracks (NATRAX)

NH-52, Old Agra- Mumbai Highway, Near to Pithampur Flyover, Post Khandwa  
(Near Pithampur)

Dhar District, Madhya Pradesh-454774

Phone: +919893892310, Fax - 07292-256101



Tender No. NATRAX/PROC/PG-C&M/26/135



NOTICE INVITING TENDER

**"Providing/Casting RCC Dead Load Block (DLB) for Testing Laden Vehicle (LCV & HCV)" at NATRAX- Pithampur"**

"

**Tender No. NATRAX/PROC/PG-C&M/26/135.**

<p>नेशनल ऑटोमोटिव टेस्ट ट्रैक्स (NATRAX), नेशनल ऑटोमोटिव बोर्ड (NAB) के तहत एक ऑटोमोटिव टेस्टिंग एंड सर्टिफिकेशन सेंटर है, जो भारी उद्योग मंत्रालय, भारत सरकार द्वारा गठित एक स्वायत्त निकाय है। NATRAX को लगभग 3000 एकड़ भूमि पर पीथमपुर, जिला धार, (मध्य प्रदेश, भारतके पास), सभी प्रकार के ऑटोमोबाइल के व्यापक परीक्षण और मूल्यांकन के लिए स्थापित किया गया है।</p>	<p>National Automotive Test Tracks (NATRAX) is an Automotive Testing &amp; Certification Centre under National Automotive Board (NAB) which is an autonomous body under Ministry of Heavy Industries, Government of India. NATRAX has been set up on approx. 3000 acres of land for comprehensive testing and evaluation of all types of automobiles ranging from two wheelers to heavy commercial vehicles.</p>
<p>NATRAX, निविदा संख्या NATRAX/PROC/PG-C&amp;M/26/135 के तहत NATRAX-पीथमपुर में लोड किए गए वाहनों (LCV और HCV) की टेस्टिंग के लिए RCC डेड लोड ब्लॉक (DLB) उपलब्ध कराना/बनाना का प्रस्ताव के लिए दो बोली प्रणाली में मुहरबंद निविदाएं आमंत्रित करता है।</p>	<p>NATRAX hereby invites sealed tenders in two bids system for "Providing/Casting RCC Dead Load Block (DLB) for Testing Laden Vehicle (LCV &amp; HCV)" at NATRAX- Pithampur" under Tender No. NATRAX/PROC/PG-C&amp;M/26/135</p>
<p>कृपया ध्यान दें, NATRAX, आदेश संख्या P-45021/2/2017-पीपी (बीई-II) दिनांक 4 जून 2020, के अनुसार उद्योग और आंतरिक व्यापार, भारत सरकार के संवर्धन विभाग द्वारा जारी "सार्वजनिक खरीद (मेक इन इंडिया को प्राथमिकता), आदेश 2017- संशोधन" पर आदेश और इस संबंध में अन्य दिशानिर्देशों का पालन करेगा</p>	<p>Please note that, NATRAX shall follow the order on "Public Procurement (Preference to Make in India), Order 2017- Revision" issued by Department for Promotion of Industry and Internal Trade, Government of India, as per their Order Number P-45021/2/2017-PP (BE-II) dated 4th June 2020 and other guidelines in this regard.</p>



**Tender No. NATRAX/PROC/PG-C&M/26/135**



The details of the tender are as mentioned below;

Particular	In Hindi	In English
Tender No.	<u>NATRAX/PROC/PG-C&amp;M/26/135.</u>	<u>NATRAX/PROC/PG-C&amp;M/26/135.</u>
Name of work	NATRAX-पीथमपुर में लोड किए गए वाहनों (LCV और HCV) की टेस्टिंग के लिए RCC डेड लोड ब्लॉक (DLB) उपलब्ध कराना/बनाना का प्रस्ताव।	"Providing/Casting RCC Dead Load Block (DLB) for Testing Laden Vehicle (LCV & HCV)" at NATRAX- Pithampur
Minimum Eligibility Criteria	<p>1. कानूनी रूप से वैध इकाई: बोली लगाने वाला अनिवार्य रूप से कानूनी रूप से वैध इकाई या तो मालिकाना फर्म, साझेदारी फर्म, प्राइवेट लिमिटेड कंपनी के रूप में होना चाहिए। जेवी/कंसोर्टियम के रूप में बोली लगाने वाले को अनुमति नहीं है</p> <p>2. वित्तीय क्षमता: कम से कम रुपये का औसत वार्षिक वित्तीय कारोबार पिछले 3 वित्तीय वर्षों ( 2022-23, 2023-24 &amp; 2024-25) में 25 लाख होना चाहिए।</p> <p>3. तकनीकी क्षमता: पिछले 7 वर्षों में समान कार्य* घटक पूरा किया हो।</p> <p>i. अनुमानित लागत का कम से कम 80% का एक समान कार्य।</p> <p>ii. अनुमानित लागत के कम से कम 50% के दो समान कार्य।</p> <p>iii. अनुमानित लागत के कम से कम 40% के तीन समान कार्य।</p> <p>किसी भी सरकारी विभाग/प्रतिष्ठित फर्म/प्राइवेट संस्थान/शैक्षणिक संस्थान/आदि के लिए बिल्डिंग/फेंसिंग/फैब्रिकेशन/RCC रोड और संबंधित कामों को सफलतापूर्वक पूरा करना, जिसमें बिल्डिंग/ट्रैक/रोड की टेस्टिंग भी शामिल है।</p>	<p>1. Legal Valid Entity: The Bidder shall necessarily be a legally valid entity either in the form of Proprietary firm, Partnership firm, Private Limited Company. Bidder in the form of JV/consortium is not permitted</p> <p>2. Financial Capacity: Should have the Average Annual Financial turnover of at least Rs. 25 Lakh in the last 3 financial years ( 2022-23, 2023-24 &amp; 2024-25).</p> <p>3. Technical Capability: Should have completed <i>Similar works*</i> component in the last 7 years.</p> <p>i. One similar work of at least 80% of estimated cost.</p> <p>ii. Two similar works of at least 50% of estimated cost.</p> <p>iii. Three similar works of at least 40% of estimated cost.</p> <p><i>"Similar Works" Successful completion of civil engineering works for buildings/ roads/ test tracks/ fencing works /fabrication works /RCC road and allied work for testing Building/Track/Road for any Government Department/ Reputed firm/ Private Institute/ Academic Institute/etc.</i></p>



*[Handwritten signature]*

Tender No. NATRAX/PROC/PG-C&M/26/135



Bid Security Amount (EMD)	ईएमडी का मूल्य: INR 18,000 / -, राष्ट्रीय मोटर वाहन परीक्षण ट्रैक के पक्ष में होगा और पीथमपुर में एक शाखा वाले अनुसूचित बैंक से कम से कम 120 दिनों के लिए वैध निम्न में से किसी भी रूप में होगा (तकनीकी बोली के साथ संलग्न किया जाए)। 1. पीथमपुर में देय डीडी। 2. बैंक गारंटी। 3. बैंकर्स चेक।	The value of the EMD shall be INR 18,000/- favoring National Automotive Test Tracks and shall be in any of the following forms valid for at-least 120 days from a scheduled bank having a branch at Pithampur (To be enclosed along with the technical bid). 1. DD payable at Pithampur. 2. Bank Guarantee. 3. Banker's Cheque.
Cost of tender documents	बिना मूल्य के	Free of Cost
Estimate cost	Rs 8,72,000/- रुपये (जीएसटी सहित)	Rs 8,72,000/- (incl. GST)
Completion period	40 दिन (बारिश के मौसम सहित)	40 days (incl. rainy season)
Sale of tender documents	BOQ और ड्रॉइंग सहित संपूर्ण "निविदा दस्तावेज़" NATRAX और CPPP पोर्टल और <a href="http://www.natrax.in">www.natrax.in</a> से बिना मूल्य के द्वारा 28 जनवरी 2026 से 10 फरवरी 2026 को 17.00 बजे तक बजे तक दिए गए खाते के विवरण में जमा करके डाउनलोड किए जा सकते हैं। या "नेशनल ऑटोमोटिव टेस्ट ट्रैक्स" (NATRAX) NH-52, ओल्ड आगरा-मुंबई हाईवे, पीथमपुर फ्लाईओवर के पास, पोस्ट खंडवा (पीथमपुर के पास, जिला धार (म.प्र.)) के कार्यालय से सीधे लिए जा सकता है।	The complete "Tender Documents" can be downloaded from NATRAX website <a href="http://www.natrax.in">www.natrax.in</a> and <a href="http://cppp">cppp</a> portal on free of cost from 10.00 hrs on 28 <sup>th</sup> January 2026 to 17.00 hrs on 17 <sup>th</sup> Feb 2026. Interested bidders may write an email on ( <a href="mailto:a.prabhakar@natrax.in">a.prabhakar@natrax.in</a> , <a href="mailto:je.procurement@natrax.in">je.procurement@natrax.in</a> ) or collect soft copy by visiting below office address in working days; National Automotive Test Tracks (NATRAX) NH-52, Old Agra-Mumbai Highway, Near to Pithampur Flyover, Post Khandwa (Near Pithampur), Dhar district, Madhya Pradesh
Period of issue of tender documents.		28 <sup>th</sup> January 2026 10:00 Hrs. to 17.00 Hrs on 17 <sup>th</sup> Feb, 2026.
The Last Date of receipt of pre bid queries from bidders, if any,		Within 9 <sup>th</sup> February 2026 17:00 Hrs
Date for pre bid clarification meeting		ऑनलाइन मोड के माध्यम से 10 <sup>th</sup> feb 2026 को 11.00 बजे / 11.00 Hrs on 10 <sup>th</sup> Feb 2026, through on line mode (Meeting link shall be shared separately)

Tender No. NATRAX/PROC/PG-C&M/26/135

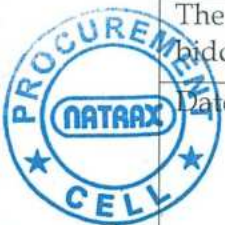

*[Handwritten signature]*



Last date/Time for submission of Sealed Bids	18 <sup>th</sup> Feb 2026 को 16:00 बजे तक मुख्यालय कार्यालय NATRAX में / Up to 16.00 Hrs on 18 <sup>th</sup> February, 2026, at HQ office NATRAX
Date/Time of opening of technical bids.	18 <sup>th</sup> Feb 2026 at 4:30 PM at NATRAX HUB/ 18 <sup>th</sup> February, 2026 को 16.30 बजे मुख्यालय कार्यालय NATRAX में / 16.30 Hrs on 18 <sup>th</sup> February 2026 at HQ office NATRAX
<ul style="list-style-type: none"><li>• NATRAX बिना कोई कारण बताए निविदा को अस्वीकार/संशोधित/रद्द करने का अधिकार सुरक्षित रखता है।</li><li>• दस्तावेज़ को हिंदी और अंग्रेजी दोनों भाषाओं में तैयार किया गया है; हालाँकि किसी भी विसंगति के मामले में अंग्रेजी प्रबल होगी।</li></ul>	<ul style="list-style-type: none"><li>• NATRAX reserves the right to reject/modify/cancel the tender without assigning any reason thereof.</li><li>• The document has been prepared in both the language Hindi &amp; English; however, in case of any discrepancy the English shall prevail.</li></ul>

**National Automotive Test Tracks (NATRAX)**  
NH-52, Old Agra-Mumbai Highway,  
Near to Pithampur Flyover,  
Post Khandwa (Near Pithampur, Dist. Dhar (M.P.).

Phone: +91-9893892310, Email: [a.prabhakar@natrax.in](mailto:a.prabhakar@natrax.in); [je.procurement@natrax.in](mailto:je.procurement@natrax.in),  
Website: [www.natrax.in](http://www.natrax.in)



Tender No. NATRAX/PROC/PG-C&M/26/135



**NATIONAL AUTOMOTIVE TEST TRACKS**

**TENDER DOCUMENTS FOR**

**“Providing/Casting RCC Dead Load Block(DLB) for  
Testing Laden Vehicle(LCV&HCV)”at NATRAX-  
Pithampur” Dhar District, M.P**

**Tender No:NATRAX/PROC/PG-C&M/26/135.**

**COVER PAGE**

**This Tender Contains:**

**1. Technical Bid:**

- (i) Other Conditions of Contract (OCC)
- (ii) Technical Conditions of Contract (TCC)

**2. Financial Bid**

- (i) Letter of Financial Proposal
- (ii) Bill of Quantities (BOQ)

**National Automotive Test Tracks (NATRAX)**

NH-52, Old Agra- Mumbai Highway, Near to Pithampur Flyover, Post Khandwa (Near  
Pithampur), Dhar District, Madhya Pradesh-454774

Phone: +919893892310, Fax – 07292-256101





## Table of content

Part/Section	Details	Ref. Page
<b>Technical Bid</b>		
<b>Part 1</b>	<b>The Other Conditions of Contract (OCC)</b>	
Section 1	Section 1- Technical Bid Submission Form	
Section 2	Section 2- Disclaimer	
Section 3	Section 3- Instructions to the Bidders	
Section 4	Section 4- General Conditions of Contract (GCC)	
Section 5	Section 5- Special Conditions of Contract (SCC)	
Section 5.1	Section 5.1- Milestones	
Section 6.1	Form of Articles of Agreement	
Section 6.2	Form for Sub Contractor's Warranty	
Section 6.3	Form of Performance Bank Guarantee	
Section 7.1	Form for Financial capacity	
Section 7.2	Form for technical Capability (Annex- A&B)	
Section 7.3	Personal Capability	
Section 7.4	Technical Capability	
Section 8	Section 8- Contact Details Form	
Section 9	Section 9- Check List	
<b>Part 2</b>	<b>The Other Conditions of Contract (OCC)</b>	
Section 10.1	Technical Specifications Civil Works	
Section 10.2	Technical Specifications Utility Works	
Section 11	Drawings	
Section 12	Forms for pre-bid (Technical & Commercial) Queries	
<b>Financial Bid</b>		
Section 13	<b>Financial Bid submission form</b>	
Section 14	<b>Bill of Quantities (BOQ)</b>	





NATIONAL AUTOMOTIVE TEST TRACKS

**TENDER DOCUMENTS FOR**

**“Providing/Casting RCC Dead Load Block(DLB) for Testing Laden Vehicle(LCV&HCV)” at NATRAX- Pithampur”**

Tender No:NATRAX/PROC/PG-C&M/26/135.

COVER PAGE- OTHER CONDITIONS OF CONTRACT (OCC)

This Tender Contains:

1. The Other Conditions of Contract (OCC) in the following parts:
  - Section 1- Technical Bid Submission Form
  - Section 2- Disclaimer
  - Section 3- Instructions to the Bidders
  - Section 4- General Conditions of Contract (GCC)
  - Section 5- Special Conditions of Contract (SCC)
    - Section 5.1- Milestones
  - Section 6- Contract Forms for information and due acceptance.
    - 6.1 Form of Articles of Agreement
    - 6.2 Form for Sub Contractor's Warranty
    - 6.3 Form of Performance Bank Guarantee
  - Section 7- Contract forms for evaluation.
    - 7.1 Form for Financial capacity
    - 7.2 Form for technical Capability (Annex- A&B)
    - 7.3 Personal Capability
    - 7.4 Technical Capability
  - Section 8- Contact Details Form
  - Section 9- Check List

**National Automotive Test Tracks (NATRAX)**

NH-52, Old Agra- Mumbai Highway, Near to Pithampur Flyover, Post Khandwa (Near Pithampur)

Dhar District, Madhya Pradesh-454774

Phone: +919893892310, Fax – 07292-256101





**Section-1- TECHNICAL PROPOSAL SUBMISSION FORM**

**LETTER OF BID**

[Location, Date]

To,  
The Head Procurement & Stores  
NATIONAL AUTOMOTIVE TEST TRACKS (NATRAX)  
Agra – Mumbai Highway (NH – 52),  
Next to Pithampur Flyover,  
Post- Khandwa (Near Pithampur) Dist. Dhar  
Madhya Pradesh – 454774  
Ref: Tender No. -----

We, the undersigned, declare that: “We have examined and have no reservations to the Bidding Documents, including Addenda issued in accordance with Instructions to Bidders. We offer to execute in conformity with the Bidding Documents of the following Works **“Providing/Casting RCC Dead Load Block(DLB) for testing Laden Vehicle(LCV&HCV)at NATRAX-Pithampur, Dhar District, M.P under Tender No: NATRAX/PROC/PG-C&M/26/135.** Bid shall be valid for a period of **120 days** from the actual date of submission of bid, in accordance with the Bidding Documents, and it shall remain binding upon us and may be accepted at any time before the expiration of that period.

- (a) If our bid is accepted, we commit to obtain a performance security in accordance with the Bidding Documents;
- (b) We are not associated nor have been associated in the past, directly or indirectly, with a consultant, or any other entity that has prepared the design, specifications and other documents for this Invitation for Bids.
- (c) We also declare that the Government of India Or any Govt. bodies has not declared us, and any of our Sub contractors or Consultants for any part of the Contract ineligible or black listed on charges of engaging in corrupt, fraudulent, collusive or coercive practices or any failure/lapses of serious nature.
- (d) We understand that you are not bound to accept the highest ranked bid or any other bid that you may receive.

Yours sincerely,

Authorized Signature [In full]:

Authorized Signature [In initials]:

Name and Title of Signatory:

Name of Firm:

Address:

[Note1: Authorized person signing shall attach to this document a proof of authorization for signing on behalf of the Bidder Company]

[Note2: To be signed in blue ink]

[Note3] To be executed on Bidder's letter Head.





## SECTION-2- DISCLAIMER

- 2.1. NATRAX is an Automotive Testing & Certification Centre under NATIONAL AUTOMOTIVE BOARD (NAB). NATRAX Centre is being set up on approx. 3000 acres for comprehensive Testing & evaluation of all type of automobiles near Pithampur, Dist. Dhar (Madhya Pradesh, India).

This Bidding Document ("Bidding Document") has been prepared by (NATRAX/ Employer") for the purpose of providing certain information to the entities, who have been participated in this open tender, through a competitive bidding process for the selection of a bidder for "Tender document for "Providing/Casting RCC Dead Load Block(DLB) for testing Laden Vehicle(LCV&HCV)at NATRAX- Pithampur, Dhar District, M.P under Tender No: NATRAX/PROC/PG-C&M/26/135.

The information contained in the Bidding Document is being provided for the limited purposes of enabling the bidders to prepare and submit a bid and for no other purpose. Under no circumstances shall NATRAX, or its respective advisers, consultants, contractors, servants and/or agents incur any liability arising out of or in respect of the issue of this Bidding Document or the selection procedure.

- 2.2. This Bidding Document is being made available by NATRAX to the bidders on the terms set out in this Bidding Document. The transfer, possession or use of this Bidding Document in any manner contrary to any applicable law is expressly prohibited. The bidders shall inform themselves concerning, and shall observe any applicable legal requirements.
- 2.3. This Bidding Document is a summary of available information and no reliance shall be placed on any information or statements contained herein, and no representation or warranty, expressed or implied, is or will be made in relation to such information and no liability is or will be accepted by NATRAX, its respective advisers, consultants, contractors, servants and/or its advisers in relation to the accuracy, adequacy or completeness of such information or statements made, nor shall it be assumed that such information or statements will remain unchanged.
- 2.4. The information does not purport to be comprehensive or to have been independently verified. Nothing in this Bidding Document shall be construed as legal, financial or tax advice. NATRAX will not be liable for any costs, expenses, however so incurred by the bidders in connection with the preparation of their bids.
- 2.5. NATRAX reserves the right to amend this Bidding Document and any information contained herein at any time by a notice, in writing, to the bidders.
- 2.6. Nothing in this Bidding Document is, nor shall be relied upon as, a promise or representation as to NATRAX's ultimate decision in the selection of the successful bidder as to undertake the work ("Contractor"). NATRAX expects to shortlist the successful bidder (s) in accordance with this Bidding Document on the basis of the bids submitted. The bidder(s) shall not, therefore, assume that they will have the opportunity to revise their bids following submission and before short-listing, except as provided in this Bidding Document. However, NATRAX reserves the right to change the basis of or the procedures (including the timetable) relating to the bidding process, reject any, or all, of the bids, not to invite a bidder to proceed further, not furnish a bidder with additional information nor otherwise to negotiate





with a bidder in respect of the works or the selection of the Contractor at any time. NATRAX does not undertake to accept the lowest or indeed any bid.

- 2.7. No person other than [HEAD PROCUREMENT & STORES] has been authorised by NATRAX to give any information or to make any representation not contained in this Bidding Document and, if given or made, any such information or representation shall not be relied upon as having been so authorised.
- 2.8. Nothing contained in this Bidding Document is, or shall be relied upon as, a representation of fact or promise as to the future. Any summaries or descriptions of documents or contractual arrangements contained in any part of this Bidding Document are only indicative and cannot be and are not intended to be comprehensive, nor any substitute for the underlying documentation (whether existing or to be concluded in the future), and are in all respects qualified in their entirety by reference to them.
- 2.9. NATRAX, its respective advisers, consultants, contractors, servants and/or agents do not accept any responsibility for the legality, validity, effectiveness, adequacy or enforceability of any documentation executed, or which may be executed, in relation to the selection and appointment of a Contractor. No legal or other obligation shall arise between any bidder and NATRAX unless and until a binding contract ("Contract") has been formally executed by NATRAX and the Contractor and any conditions precedent to the effectiveness of the Contract have been fulfilled. NATRAX shall not be obliged to appoint any of the bidders to undertake the performance, execution and implementation of the work and NATRAX reserves the right not to proceed with the selection procedure and to withdraw from the selection procedure, or any part thereof, at any time.
- 2.10. Nothing in this Bidding Document shall constitute the basis of the contract or the selection of the contractor nor shall such documentation/ information be used in construing any such Contract. Each bidder must rely on the terms and conditions contained in any contract, when, and if, finally executed, subject to such limitations and restrictions which may be specified in such contract. Reference is drawn to the Special Conditions of Contract (SCC) which shall form a part of the Contract.
- 2.11. The bidder(s) are prohibited from any form of collusion or arrangement (directly or through their respective advisers or consultants) in an attempt to influence the award process. Giving or offering of any gift, bribe or inducement or any attempt to any such act on behalf of a bidder towards any officer/ employee of NATRAX or to any other person in a position to influence the decision of NATRAX for showing any favour in relation to this selection process or any other contract, shall render such bidder to such liability/penalty as NATRAX may deem proper, including but not limited to rejection of the bid of the bidder.
- 2.12. The laws of the Republic of India shall be applicable to this Bidding Document. The Courts at Madhya Pradesh shall have exclusive jurisdiction in relation to any disputes arising from this Bidding Document.
- 2.13. This Bidding Document is confidential and personal to each bidder. The bidders shall not disclose any of Confidential Information given in the tender document to any person or body corporate except to the extent permitted under this Bidding Document. The bidders shall promptly return this Bidding Document to NATRAX upon request or as specified in this Bidding Document. Any failure to furnish or





comply with the terms of the Letter of Undertaking shall entitle NATRAX to disqualify the relevant bidder.

- 2.14. Each bidder's acceptance of delivery of this Bidding Document constitutes its agreement to, and acceptance of, the terms set forth in this Disclaimer.

## SECTION-3- INSTRUCTIONS TO THE BIDDERS (ITB)

### 1.1. GENERAL INSTRUCTIONS

- 1.1.1. National Automotive Test Tracks (NATRAX) is an test centre under National Automotive Board, an autonomous body constituted by Ministry of Heavy Industries, Government of India for execution of National Automotive Test Tracks (NATRAX).

National Automotive Test Tracks (NATRAX) "Employer", is an Automotive Testing & Certification Centre under NAB. NATRAX is being set up on approx. 3000 acres for comprehensive Testing & evaluation of all type of automobiles near Pithampur, Dist. Dhar (Madhya Pradesh, India).

NATRAX herewith invites sealed Bids in **two packet system** from the reputed Civil engineering works Contractors, experienced in construction of Buildings works, and who meet the minimum eligibility criteria as mentioned below for the works, **"Providing/Casting RCC Dead Load Block(DLB) for testing Laden Vehicle(LCV&HCV)"** at NATRAX- Pithampur, Dhar District, M.P under **Tender No: NATRAX/PROC/PG-C&M/26/135**. Those who meet the minimum eligibility criteria as mentioned in this section (and also in NIT) may only be eligible to become successful in the bidding process. **The bidder in the form of JV/Consortium is not permitted.** The details of the tender are as mentioned below.

Description of works	Period of Completion	Estimated Cost	EMD Amount	Date of Prebid meeting	Date for submission of Bids	Date of opening of Bid
"Providing/Casting RCC Dead Load Block(DLB) for testing Laden Vehicle(LCV&HCV) at NATRAX- Pithampur, Dhar District, M.P under Tender No: NATRAX/PROC/PG-C&M/26/135	40 days (inclusive of Rainy season) from the date of issue of 'NTP'.	Rs 8.72 lakhs (Inclusive GST)	INR 18,000/-	10th Feb 2026 को 11.00 बजे / 11.00 Hrs on 10th Feb 2026 through online mode	Up to 16.00 Hrs on 18 <sup>th</sup> Feb 2026, at HQ office NATRAX Pithampur Distt. Dhar (M.P.)	18 <sup>th</sup> Feb 2026 at 16.30 Hrs at NATRAX HUB/ at NATRAX, Pithampur.





- 1.1.2. The term "Employer", mentioned in any part of this tender documents means, NATRAX. For all the purpose of bidding, selection process and clarifications, the Employer is represented by **Head Procurement & stores**.
- 1.1.3. While all efforts have been made to avoid errors in the drafting of the tender documents, the Bidder is advised to check the same carefully. No claim on account of any errors detected in the tender documents shall be entertained.
- 1.1.4. The Employer desires that the bidders, suppliers, and contractors under the Project, observe the highest standard of ethics during the performance, procurement and execution of such contracts. In pursuance of this requirement, the Employer:

*Defines, for the purposes of this provision, the terms set forth below:*

- (i) *"Corrupt Practice" means the offering, giving, receiving, or soliciting, directly or indirectly, anything of value to influence improperly the actions of another party;*
  - (ii) *"Fraudulent Practice" means any act of submission of forged documentation, or omission, including a misrepresentation, that knowingly or recklessly misleads, or attempts to mislead, a party to obtain a financial or other benefit or to avoid an obligation, or to succeed in a competitive bidding process;*
  - (iii) *"Coercive Practice" means impairing or harming, or threatening to impair or harm, directly or indirectly, any party or the property of the party to influence improperly the actions of a party;*
  - (iv) *"Collusive Practice" means an arrangement between two or more parties designed to achieve an improper purpose, including influencing improperly the actions of another party.*
- (a) Will reject the award of Contract, even at a later stage, if it determines that the bidder recommended/ selected for award/awarded has, directly or through an agent, engaged in Corrupt, Fraudulent, Collusive, Or Coercive Practices in competing for the Contract;
  - (b) Will sanction a party or its successors, including declaring ineligible, either indefinitely or for a stated period of time, to participate in any further bidding/ procurement proceedings under the Project, if it at any time determines that the party has, directly or through an agent, engaged in Corrupt, Fraudulent, Collusive, Or Coercive Practices in competing for, or in executing, the contract; and
  - (c) Will have the right to require the bidders, or its suppliers, contractors and consultants to permit the Employer to inspect their accounts and records and other documents relating to the bid submission and contract performance and to have them audited by auditors appointed by the Employer at the cost of the bidders.
  - (d) The Bidder must obtain for himself on his own responsibility and at his own expenses all the information which may be necessary for the purpose of making a bid and for entering into a contract, must examine the Drawings, must inspect the sites of the work, acquaint himself with all local conditions, means of access to the work, nature of the work and all matters pertaining thereto. The Employer will in no case be responsible or liable for those costs, regardless of the conduct or outcome of the bidding process.

- 1.1.5. Each page of the Tender documents should be stamped and signed by the person or persons submitting the Tender in token of his/their having acquainted himself/ themselves and accepted the entire tender documents including various conditions of contract. Any Bid with any of the documents not so signed is liable to be rejected at the





discretion of NATRAX. The signatures shall be in blue ink.

- 1.1.6. The tender prepared by the Bidder and all correspondence and documents relating to the tender exchanged between the Bidder and NATRAX shall be in the English language.
- 1.1.7. The bidder shall attach the copy of the authorization letter/power of Attorney as the proof of authorization for signing on behalf of the Bidder.
- 1.1.8. The contract shall be governed by NATRAX's General Conditions for Contract (GCC), Special Conditions for Contract (SCC), Technical Conditions for Contract (TCC) and all other relevant conditions & documents on the tender documents.
- 1.1.9. The Bidders are expected to carefully examine all the contents of the tender documents including instructions, conditions, terms, specifications, drawings and get clarifications, if required, from NATRAX and take them fully into account before submitting their offer. Failure to comply with the requirements as detailed in these documents shall be at the Bidder's own risk. Bidders which are not responsive to the requirements of the tender documents will be rejected.
- 1.1.10. All Bidders are hereby explicitly informed that conditional offers or offers with deviations from the conditions of Contract, the bids not meeting the minimum eligibility criteria, Technical Bids, not accompanied with EMD of requisite amount in acceptable format, Bids in altered/modified formats, or in deviation with any other requirements, stipulated in the tender documents are **liable to be rejected**.
- 1.1.11. The Bid submitted on behalf of a Firm shall be signed by all the Partners of the Firm or by a Partner who has the necessary authority on behalf of the Firm to enter into the proposed contract. Otherwise, **the bid is liable to be rejected by the NATRAX**.
- 1.1.12. The bidders are expected to meet the minimum eligibility criteria as given in the Notice Inviting Tender to participate in this tender. **NATRAX will reject the Bids that do not meet the minimum eligibility criteria as laid down, based on their submission along with the tender documents, even after the bid opening process is concluded.**
- 1.1.13. **The 'contact details form' need to be filled, signed and submitted to NATRAX within 3 days of purchase of tender.** NATRAX will use such details to communicate via e-mail with the bidder for issuing addenda/corrigendum, including the change of key tendering dates, revisions etc. NATRAX will not be responsible for non receipt of any such communication to the bidders, who have not submitted the contact details form.
- 1.1.14. The tender is issued to all bidders as soft copy in the form of CD. The bidders shall not tamper or modify any part of the tender documents in any manner, other than certain forms/BOQ, allowed as per conditions of tender. In case of any discrepancy between editable/PDF formats, PDF formats will supersede. In case in part of the bid is found to be tampered or modified, the bids are liable to be rejected and the full earnest Deposit will be forfeited and liable to be banned from from doing any business with NATRAX.
- 1.1.15. **Bidder in the form of JV/consortium is not permitted. Preference shall be given to bidders as per Order No. P-45021/2/2017-PP (BE-II) dated 4<sup>th</sup> June 2020, issued by Department for Promotion of Industry and Internal Trade, Government of India subject to submission of necessary documents in this regard by the bidders.**





## 1.2. MINIMUM ELIGIBILITY CRITERIA

The qualification will be based on Bidder's meeting all the following minimum **pass/fail** criteria regarding their particular experience, financial position, personnel and equipment capabilities and other relevant information as demonstrated by the Bidders responses in the forms attached. **The qualifications, capacity and resources of proposed sub-contractors will not be taken into account in determining the Bidders compliance with the qualifying criteria.**

The bidder whose bid meet the following minimum eligibility criteria would only be considered as responsive and evaluated by NATRAX.

i. **Legally Valid Entity:** *The Bidder shall necessarily be a legally valid entity either in the form of Proprietary firm, Partnership firm, Private Limited Company. Bidder in the form of JV/consortium is not permitted. A proof for supporting the legal validity of the Bidder shall be submitted.*

ii. **Financial Capacity:** *Should have the Average Annual Financial turnover of at least Rs. 25 Laksh in the last 3 financial years (2022-23, 2023-24 & 2024-25). Documentary evidence in the form of certified Audited Balance Sheets of relevant periods or a certificate from the Chartered Accountant / Cost Accountant indicating the turnover details for the relevant period shall be uploaded with the bid.*

*In case the date of constitution / incorporation of the bidder is less than 3-year-old, the average turnover in respect of the completed financial years after the date of constitution shall be taken into account for this criterion. Relevant proof for supporting the above shall be submitted or certificate from CA will be required as suggested in Section 7.1.*

iii. **Technical Capability:** *Should have completed Similar works\* component in the last 7 years meeting the following criteria:*

- (a) One similar completed work costing not, not less than @ **80% of estimated cost.**  
(OR)
- (b) Two similar completed works costing not, not less than @ **50% of estimated cost.**  
(OR)
- (c) Three similar completed works costing not, not less than @ **40% of estimated cost.**

**"Similar Works"** *Successful Completion of Civil engineering works for buildings/roads/Test Tracks/fencing works/fabrication works/RCC road and allied work for testing Building/Track/Road for any Government Department/Reputed firm/Private Institute/Academic Institute etc.*

*For the purpose of assessment of technical capability, the latest cutoff date of work is 30 days prior to last date of submission of Bid Document.*



*As the proof for having fully adhered to the minimum eligibility criteria at para (3),*



*NATRAX shall accept the self-attested completion certificates issued by Govt. Depts/Autonomous bodies/PSUs/reputed private firms/automobile manufacturers/Pvt. Ltd. Firms (at the discretion of NATRAX) only. In case of submission of certificates from the private firms, the TDS certificate in support of the certificate issued by the private firms shall also be submitted. Any document other than the above will not be accepted by NATRAX.*

### 1.3. SITE VISIT

- 1.3.1. The Bidders are advised to visit and examine the Site of Works and its surroundings, with prior notice to NATRAX, at his/their cost and obtain for himself / themselves on his/their own responsibility, all information that may be necessary for preparing the tender and entering into a Contract. The Bidder shall be deemed to have inspected the Site and its surroundings before hand and taken into account all relevant factors pertaining to the site in the preparation and submission of the Tender.
- 1.3.2. The bidder and any of its personnel or agents will be granted permission by the Employer to enter upon its premises and lands for the purpose of such visit, but only upon the express condition that the bidder, its personnel, and agents, will release and indemnify the Employer and its personnel and agents from and against all liability in respect thereof, and will be responsible for death or personal injury, loss of or damage to property, and any other loss, damage, costs, and expenses incurred as a result of the inspection.
- 1.3.3. **Address of the Site: National Automotive Test Tracks (NATRAX),NH-52, Old Agra- Mumbai Highway, Near to Pithampur Flyover,Post Khandwa (Near Pithampur),Dist. Dhar (M.P.)-454774**

### 1.4. SPECIFIC INSTRUCTIONS ON WORKS

- 1.4.1. The detailed scope of works are described under Technical Conditions of Contract (TCC), along with the detailed specifications, drawings, bill of quantities etc.
- 1.4.2. The successful bidder has to start the works simultaneously so as to complete the works within the specified completion period.
- 1.4.3. The sub-contractor, if any proposed by the successful bidder, after award of work, should have adequate experience, own/established access to required man power, machineries and construction equipments and the contractor shall get prior approval from NATRAX before the start of the work.
- 1.4.4. The work shall be carried out strictly in accordance with the specifications given in the tender and also in compliance of the requirements of the Authorities concerned and deviation on any account will not be permitted.
- 1.4.5. The Bidder shall carry out all the works strictly in accordance with Drawings, details, specifications, standard engineering practices and instructions of NATRAX or NATRAX's authorized representative. In case the changes that have been made in the design by NATRAX during execution, the Bidder shall have to carry out the same within the provisions of contract and mutually agreed terms and conditions.
- 1.4.6. The successful Bidder must co-operate with the other contractors/suppliers and representatives appointed by NATRAX to ensure that the work proceeds smoothly with the least possible delay and to the satisfaction of NATRAX.





- 1.4.7. The successful Bidder is bound to carry out the works, that consists of any minor/sub items, necessary for the completion of the works as covered in this tender to achieve end results and conventionally included in works, even though such minor/sub items are not included in the Bill of quantities and drawings, are deemed to be priced in the other items/works. No separate claim on this account shall be entertained, unless it is explicitly brought to the notice of NATRAX in writing before the start of such item works and accepted by NATRAX.
- 1.4.8. The works under this tender will be governed by item rate contract.
- 1.4.9. 4.9 In case the work is awarded in parts by splitting the contract among the bidders and the other works such as services/ utilities which may be done simultaneously by NATRAX's other specialized agencies, then the works to be carried out in co-ordination with such agencies for integration of works by overlapping various activities.

#### 1.5. TIME SCHEDULE FOR COMPLETION OF WORKS

- 1.5.1. Time is the essence of the contract. The work is to be completed within the stipulated time i.e. 40 days from the date of issue of 'Notice to Proceed' to the successful Bidder.
- 1.5.2. Time allowed for carrying out the works as mentioned in the tender documents shall be strictly observed by Bidder and it shall be reckoned from the date of issue of 'Notice to Proceed'. In the event of urgency this may also be consider from the date of Issue of LoA if the same is desired by NATRAX.

#### 1.6. EARNEST MONEY DEPOSIT (BID SECURITY AMOUNT)

- 1.6.1. The bids should be accompanied by an Earnest Money Deposit as specified in the form of Bank Guarantee / Banker's Cheque / Demand Draft /Fixed Deposit , drawn in favour of *National Automotive Test Tracks, payable at Pithampur valid for 120 days, from any of the scheduled bank in India*. The BG issued by any scheduled bank in India in bank's own approved format is acceptable to NATRAX.
- 1.6.2. A tender which is not accompanied by such Earnest Money Deposit will be rejected.
- 1.6.3. **NATRAX reserves the right of forfeiture of Earnest Money Deposit in case, the bidder:**
- Does not reply to any queries raised by NATRAX, within the stipulated period that may be raised after opening of the technical or financial bids.
  - After opening the financial bids, revokes his technical/financial offer or alters any of the quoted rates/conditions of tender.
  - Does not accept the corrections made by NATRAX to its Bid Price, pursuant to examination of financial proposal and correction of arithmetical errors.
  - Has not accepted 'Letter of Acceptance' within the stipulated time.
  - Fails to provide/ furnish the Performance Bank Guarantee within stipulated period as mentioned in the Letter of Acceptance.
- 1.6.4. In case of forfeiture of EMD, the Bidder shall be debarred from the bidding, incase of Re-invitation of bids and all forthcoming tenders of NATRAX.





## 1.7. PRE-BID MEETING

- 1.7.1. The bidder or his official representative is invited to attend a pre-bid meeting, which, if convened, will take place at the NATRAX Site, **National Automotive Test Tracks (NATRAX),NH-52, Old Agra- Mumbai Highway,Near to Pithampur Flyover,Post Khandwa (Near Pithampur),Dist. Dhar (M.P.)-454774**

*Virtual meeting Link of the meeting shall be shared only with those who submit their pre-bid query by 11.00 Hrs on 10th Feb 2026*

- 1.7.2. The purpose of the meeting will be to clarify issues and to answer questions on any matter that may be raised at that stage.

- 1.7.3. The bidder is requested, to submit any questions in writing, e-mail or by fax, to reach the Employer not later than **17.00 Hrs on 9<sup>th</sup> Feb 2026**

- 1.7.4. Minutes of the meeting, including the text of the questions raised and the responses given, together with any responses prepared after the meeting, will be issued without delay to all purchasers of the bidding documents. Any modification of the bidding documents listed in Sub-Clause which may become necessary as a result of the pre-bid meeting shall be made by the Employer exclusively through the issue of an Addendum, vide Clause 8 and not through the minutes of the pre-bid meeting.

- 1.7.5. Non-attendance at the pre-bid meeting will not be a cause for disqualification of a bidder.

## 1.8. AMENDMENT TO THE TENDER DOCUMENT

- 1.8.1. Any amendment to the tender document may be issued to the bidders through addendum/ corrigendum, prior to date of opening of the tenders, to intimate the bidders regarding revisions/changes/modifications to tender documents, changes in the key tendering dates, clarifications on queries raised by the bidders etc. All such communications to the bidder would be in the form of soft copy and may sent to the bidder's **E-mail ID as mentioned in the 'contact details form', submitted by the bidder within 3 days after the purchase of tender documents or e-published on NATRAX and/or Govt.'s e-procurement portals.**

- 1.8.2. In order to afford prospective bidders, reasonable time for preparing their tenders after taking into account such amendments, NATRAX may, at its discretion, extend the deadline for submission of tenders.

- 1.8.3. Addendum/corrigendum shall be an integral part of the tender and required to be complied as per para-10, 'Instructions for preparation of bids'.

- 1.8.4. A prospective bidder requiring any clarification of the bidding documents may notify the Employer in writing or by e-mail/Fax at the Employer's address indicated in the





Tender document. The Employer will respond to any request for clarification, which he receives earlier than 7 days prior to the deadline for submission of bids. Copies of the Employer's response will be forwarded to all purchasers of the bidding documents, including a description of the inquiry but without identifying its source. NATRAX will not be held responsible for non receipt of any such communication to the bidders, who have not submitted the contact details form within 3 days of receipt of tender document..

#### 1.9. VALIDITY OF BIDS

- 1.9.1. Bids shall remain valid and open for acceptance for a period of **120 days** from the last date of submission of Bids.
- 1.9.2. If a bidder withdraws or revokes his offer or revises the quoted rate or condition for any item within the aforesaid period, his Earnest Money Deposit is liable to be forfeited.
- 1.9.3. In case NATRAX calls the bidder for negotiations then this shall not amount to cancellation or withdrawal of original offer which shall be binding on the bidder.
- 1.9.4. Any Bid having validity lower than that specified above shall be rejected by NATRAX as being non responsive. However, NATRAX may request the Bidders in writing to extend the Bid unconditionally beyond the Bid validity period up to an additional period of sixty (60) days without any modification and with out giving any reason thereof on exceptional cases. Conditional extension of bid validity shall not be accepted and NATRAX reserves right to reject such bid/s and proceed with the bidding process with the remaining bidders.

#### 1.10. INSTRUCTIONS FOR PREPARATION OF BIDS

##### A. CONTENTS OF THE BIDDING DOCUMENT

##### (I) THE TECHNICAL BID CONTAINS THE FOLLOWING SECTIONS:

##### Other Conditions of Contract (OCC)

Section 1- Technical Bid Submission Form

Section 2- Disclaimer

Section 3- Instructions to the Bidders

Section 4- General Conditions of Contract (GCC)

Section 5- Special Conditions of Contract (SCC)

Section 6- Contract Forms for information and due acceptance.

6.1 Form of Articles of Agreement

6.2 Form for Sub Contractor's Warranty

6.3 Form of Performance Bank Guarantee

Section 7- Contract forms for evaluation.





7.1 Form for Financial capacity

7.2 Form for technical Capability

Section 8- Contact Details Form

Section 9- Check List

The Technical Conditions of Contract (TCC):

Section 10 - Detailed Technical Specifications.

Section 11- Drawings.

Section 12- Forms for Technical & Commercial Queries

**THE FINANCIAL BID CONTAINS THE FOLLOWING SECTIONS:**

Section 13- Financial Bid Submission Form

Section 14- BOQ (Bill of Quantities for Financial Quotes)

**B. PREPARATION FOR TECHNICAL BID (To be packed in a separate envelope)**

**1.10.1.** The Tender Documents are issued to the bidders in the form of soft copy (in a CD) and the Bidders shall take printouts of all the documents (including all drawings) in paper size A4, (prints on dual sides, colour/B&W are accepted) and shall be bound in proper manner, in the order of Section Nos. and the pages shall be serially numbered. All pages need to be stamped and signed.

Wherever editable format is used, (Technical bid submission form) it shall be inserted duly filled and signed at appropriate places. Bidders shall not change/tamper any content of the formats, font size or orientation in any of the editable/PDF formats.

The addenda (corrigendum) issued by NATRAX shall also be signed and submitted in paper size A-4.

**1.10.2.** The Technical Bid shall also contain the additional documents required to be submitted as per the MEC at clause 2, (as above) for the purpose of evaluation of Bids and it shall be bound separately with all pages numbered serially. **The Bidder may avoid unwanted documentations, which are not sought as the part of tender.**

**C. PREPARATION FOR FINANCIAL BID (To be packed in a separate envelope)**

**1.10.3.** The financial Bid submission form (issued in editable format) shall be prepared duly filling (only) the required information, stamped and signed at appropriate places. Bidders shall not edit/change/tamper any of the content of the format, font size or orientation, other than the information which are the required to be filled, under the provisions of tender.



- 1.10.4. **The financial bid (BOQ) shall be PREFERABLY prepared separately in paper size A3** and shall be bound properly with each page serially numbered. In case of any revision/change/modification on financial bid format, only on the latest format shall be used for preparation of the financial bid. Submissions on old/previous formats are liable to be rejected.
- 1.10.5. The prices shall be quoted in Indian Rupees only. The bidder must quote their price strictly as per the items as described in the BOQ and shall be inclusive of all taxes and duties.
- 1.10.6. The quoted rates shall preferably be a round figure, without any fraction and if unavoidable, in the opinion of the Bidder, it shall be limited to maximum of 2 (two) decimals. Anything beyond two decimals will not be considered.
- 1.10.7. If requested, the financial Bid (BOQs) shall be issued as soft copy in excel formats, locked with password protected columns, except for the price columns, where the bidder need to fill his rate in figures and words and total amount in Figures. These columns are open for editing purpose and it has not been prefixed with any kind of arithmetical formulae for generating the total automatically. The Bidder shall use its own methods for arithmetical calculation of bid prices. Bidder shall either enter the prices in figures and words directly on the soft copy OR may fill the columns for the prices in figures and words by hand writing with pen, (blue Ink) in a clear and legible manner. The BOQs in PDF formats are also attached and in case of discrepancy this will supersede over the editable formats.
- 1.10.8. Any corrections / over-writing made by the bidder in his own hand written entries shall be stamped and signed by them against the respective entries.
- 1.10.9. The items which are not specifically detailed in the BOQ item description, but are part of the item as per standard engineering practices, are deemed to be included in the respective price and no separate / additional amount in price will be permitted for the same. The bidder shall also consider the relevant tender clause to finalise their bid price.
- 1.10.10. The Bidders are required to submit their Bid in a **single sealed envelope** containing **two separate** packets and the outer envelope shall be superscribed "**Bid for Tender No: NATRAX/PROC/PG-C&M/26/135**", with the Name and address of the Bidder.

The said outer envelope shall contain the following **sealed envelopes**:

- (a) **Financial Bid**, as given in the Tender or its latest revision issued by NATRAX, in a **separate sealed envelope**, superscribed "**Financial Bid for Tender No: NATRAX/PROC/PG-C&M/26/135**", with the Name and address of the Bidder.
- (b) **Technical Bid**, as given in the Tender, along with all required additional information, documents in support of the minimum eligibility criteria, the addenda/corrigendum if any issued by NATRAX and Valid EMD of requisite amount, in a **separate sealed envelope**, superscribed "**Technical Bid for Tender No: NATRAX/PROC/PG-C&M/26/135**", with the Name and address of the Bidder.





## 1.11. INSTRUCTIONS FOR SUBMISSION OF BIDS

- 1.11.1. The Bids shall be submitted within the stipulated time period at site office of NATRAX Site, National Automotive Test Tracks (NATRAX),NH-52, Old Agra-Mumbai Highway,Near to Pithampur Flyover,Post Khandwa (Near Pithampur),Dist. Dhar (M.P.)-454774.
- 1.11.2. Bids sent telegraphically or through other means of transmission (telefax, e-mail etc.) which cannot be delivered in a sealed envelope shall be treated as non-responsive, invalid and shall be rejected.
- 1.11.3. The Bids will be opened as scheduled at site office of NATRAX Site, National Automotive Test Tracks (NATRAX),NH-52, Old Agra- Mumbai Highway,Near to Pithampur Flyover,Post Khandwa (Near Pithampur),Dist. Dhar (M.P.)-454774 in the presence of Bidders or their duly authorised representatives who choose to remain present at the time of opening the tender.
- 1.11.4. No Bid will be accepted after the aforesaid date and time. However on exceptional cases NATRAX reserves right to extend the time/last date of submission of bids to a next convenient time/date, before opening of the Technical bids.

## 1.12. WITHDRAWAL OF BID

- 1.12.1. No Bidder is permitted to withdraw their already submitted bid after the the last date/time of submission of bids. Incase of bids send by courier/post etc. can be withdrawn before the closure of last date /time for submission of bids, on written request from the bidder.

## 1.13. BID OPENING PROCEDURE

- 1.13.1. The bids shall be opened in the presence of bidders or their duly authorized representatives at the time mentioned in the tender/corrigendum, in the presence of the members of the NATRAX's Tender opening committee.
- 1.13.2. A letter of authorization shall be submitted to NATRAX, by the Bidder's representative before the opening of Bids.
- 1.13.3. Absence of bidders or their duly authorized representatives shall not impair the legality of the bid opening process.
- 1.13.4. All bidders or their duly authorized representatives shall be required to sign the main bid envelopes by way of confirmation of sealed bid status at the time of opening of bids.
- 1.13.5. After identification signing, the committee member/representative shall open the main bid envelope.

### A. [TECHNICAL BID]

- 1.13.6. The technical bid envelope shall be then opened and the EMD shall be verified for specified value and validity. This will not give any right to the bidder to claim that he is successful in the bidding process. The Financial bid envelopes shall be required to sign by all the authorized representatives and the same will be kept under the custody of NATRAX. The technical Bids will be evaluated later to ensure that the bidder meets the minimum eligibility criteria as specified in the Instruction to the bidders (and NIT).





- 1.13.7. Refusal to sign on any of the bid envelopes by any of the bidder or his duly authorized representative may disqualify him from the process at the discretion of members of the tender opening committee present at the time of opening of the Bids.
- 1.13.8. The bids shall be declared to be 'Valid' or 'Invalid' at the conclusion of preliminary scrutiny process, at the discretion of the members of the tender opening committee present on the spot. The decision on declaring the bid is also subject to the submission of valid EMD of requisite amount and prima facie appearance of the bidding documents on totality.
- 1.13.9. Bids declared invalid shall be returned on the spot to the respective bidders. In case, the Bidder or its representative whose Bid has been declared invalid is not present at the time of opening of the Bids, the Bid shall be returned to the Bidder duly intimating him to collect the same from NATRAX.
- 1.13.10. The conditional acceptance of any bid that does not meet the above preliminary acceptance criteria shall solely rest with NATRAX, in case of submission of substantially responsive bid in the opinion of NATRAX, supported with adequate documentary evidence/certification of bidder in writing.
- 1.13.11. Refusal to any of the decision of NATRAX by any of the bidder or his duly authorized representative may disqualify him from the bidding process at the discretion of members of the tender opening committee present at the time of opening of the Bids.
- 1.13.12. Decision of NATRAX shall be final and No correspondence or claim whatsoever from such/any Bidders shall be entertained or responded by NAT

#### 1.14. CLARIFICATIONS ON TECHNICAL BID EVALUATION

- 1.14.1. The technical bids shall be evaluated based on the available documents submitted by the bidder. To assist in the examination, evaluation and comparison of the bids, and qualification of the bidders, the Employer may, at its discretion, ask any bidder for a clarification of its bid. Any clarification submitted by a bidder that is not in response to a request by the Employer shall not be considered. The Employer's request for clarification and the response shall be in writing.
- 1.14.2. No change in the substance of the bid shall be sought, offered, or permitted and No additional/fresh information shall be sought by NATRAX, if considered/rectified, it would unfairly affect the competitive position of other bidders presenting substantially responsive bids.
- 1.14.3. If a bidder does not provide clarifications of its bid by the date and time set in the Employer's request for clarification, its bid may be rejected.
- 1.14.4. NATRAX also reserves right to seek confirmation/clarification from the issuer agency, on the supporting documents submitted by the bidder as per clause 3.2.1.
- 1.14.5. If the bidder is qualified in the technical bid evaluation and in case of omission of any documents in the bid, other than the documents as per clause 3.2.1, NATRAX may, at its discretion, ask the bidder in writing, to submit the same before opening of the financial bids, to consolidate their technical offer.





## 1.15. TECHNICAL BID EVALUATION (SEGREGATED TYPE)

1.15.1. NATRAX shall follow the **segregated bid evaluation system**, where the technical bids and the financial bids are evaluated separately, without integrating their merits in the technical/financial evaluation stages.

1.15.2. The technical bid evaluation is done based on the following criteria:

- (i) The responsiveness of the bid, i.e; receipts of duly filled, signed and accepted bid documents in complete, including addenda and Authorisation letter/Power of Attorney.
- (ii) Receipt of valid EMD with requisite amount in acceptable format.
- (iii) Documents in proof of meeting the minimum eligibility criteria.
- (iv) Any other documents as required to support the responsiveness of the bidder, as per tender.

1.15.3. A substantially responsive bid is one that meets the requirements of the Bidding Document without material deviation, reservation, or omission. A material deviation, reservation, or omission is one that, if accepted, it would affect in any substantial way, the scope, quality, or performance of the Works (specified in the Contract) or limit in any substantial way, inconsistent with the Bidding Document, the Employer's rights or the bidder's obligations under the proposed Contract.

1.15.4. During the evaluation of bids, the following definitions shall apply:

- (i) "Deviation" is a departure from the requirements specified in the Bidding Document;
- (ii) "Reservation" is the setting of limiting conditions or withholding from complete acceptance of the requirements specified in the Bidding Document; and
- (iii) "Omission" is the failure to submit part or all of the information or documentation required in the Bidding Document.

1.15.5. If a bid is not responsive to the requirements of the Bidding Document, it shall be rejected by the Employer and may not subsequently be made responsive by correction of the material deviation, reservation, or omission. No further evaluation of Technical Proposals will be carried out of those bidders whose Technical proposal is determined to be non-responsive and their Financial Proposals will be returned unopened.

1.15.6. The bidder, whose bid is found to be responsive in the evaluation stage, is only be considered as qualified and the result of the technical evaluation shall be **PASS/FAIL**.

1.15.7. The bidder who qualified in the technical evaluation stage shall only be called for opening of financial bids. NATRAX shall intimate the bidders, the time/ venue for the financial Bid opening in written communication.

## 1.16. FINANCIAL BID OPENING PROCEDURE

1.16.1. The Financial Bids of all the qualified Bidders shall be opened on the appointed date and time in presence of the qualified bidders/their authorized representatives, who choose to be present at the time of opening of the financial bids.





- 1.16.2. All the qualified bidders/their authorized representatives present at the time of opening of the Financial Bids shall be asked to sign on all the sealed envelopes containing the Financial Bid.
- 1.16.3. Any bidder objecting to the same shall be disqualified and his financial bid shall be returned on the spot.
- 1.16.4. Financial Bids of the qualified Bidders shall be opened in the presence of bidders or their authorized representatives.
- 1.16.5. Absence of bidders or their authorized representatives shall not legally impair the process.
- 1.16.6. The financial bid price, as indicated in the financial bid submission form of each bidder shall be read out on the spot, however, it shall be clearly stated that the final financial bid prices would be arrived at after detailed scrutiny/correction of arithmetical error in the financial bid.
- 1.16.7. Each qualified Bidder or their authorized representative shall be required to sign on the Bid price declaration sheet, against their respective price declared and also on the financial bid submission forms of all the bids. Any Bidder objecting to the same shall be disqualified.
- 1.16.8. Mere becoming the lowest bidder, prior to financial bid scrutiny will not give any right to the Lowest bidder to claim that he is successful in the bidding process.

#### 1.17. FINANCIAL BID EVALUATION

- 1.17.1. The responsiveness of the bid shall be assessed based on the submission, on the latest financial format in case revised by addenda. For the evaluation of the Financial Bids, the eventual Bid prices shall be ascertained after considering all the terms and conditions associated with the Bid price specified in the Financial Bid document (such as unit, qty, rate and total) and after detailed scrutiny of the financial bid.
- 1.17.2. For evaluation of bid prices, NATRAX shall consider the item rate up to the fraction of 2 decimals only.

#### Procedure for Arithmetical correction

- 1.17.3. NATRAX reserves the right to include or exclude any component of the financial bid or the price quoted by the Bidder, and/or, load the bid price as per its discretion to bring the bids at a common platform and to ensure level playing of bids to work out the Bid Price for evaluation and comparison of bid prices.
- 1.17.4. If there is a discrepancy between the sub total/s and the total price that is obtained by multiplying the unit price and quantity/adding the sub total/s, the sub total/s shall prevail and the total price shall be corrected, unless in the opinion of the Employer that there is an obvious misplacement of the decimal point in the sub total price, in which case the total price as quoted shall govern and the sub total/s shall be corrected;
- 1.17.5. If there is an error in a total, corresponding to the addition or subtraction of sub totals, the subtotals shall prevail and the total shall be corrected; and
- 1.17.6. If there is a discrepancy between words and figures, the amount in words shall prevail, unless the amount expressed in words is related to an arithmetic error, in which case the amount in figures shall prevail subject to relevant clauses referred above.





- 1.17.7. The amount stated in the Letter of Bid will be adjusted by the Employer in accordance with the above procedure for the correction of errors and, shall be considered as binding upon the bidder. If the bidder does not accept the corrected amount of bid, its bid will be rejected, and the bid security shall be forfeited as per relevant clauses.
- 1.17.8. If a discount is offered in a financial proposal, such discount will be applied on prorata basis against each item of the financial form except the price part/s not considered for the "Total price for the package".
- 1.17.9. In case an additional component is loaded by the bidder on its bid price, after totaling the prices of schedules, such sum shall be applied on prorata basis on all the items to work out the item rates.

#### 1.18. DETERMINATION OF THE SUCCESSFUL BIDDER

The Bidder meeting the minimum eligibility criteria with the lowest bid price, subject to arithmetical correction, shall be deemed as the successful Bidder.

- 1.18.1. In the event of more than one bidder with the lowest price bids (say equal), the bidder with the highest 'cumulative annual average turn over of the last 3 F.Ys' would be deemed as 'Successful Bidder' with respect to the submission of proof of documents as required by the client/submitted by the bidders.

#### 1.19. CONTRACT NEGOTIATIONS

- 1.19.1. If the bid is seriously unbalanced, front loaded or substantially below updated cost estimates in the opinion of the Employer, the Employer may require the bidder to produce detailed price analyses for any or all items of the Bill of Quantities, to demonstrate the internal consistency of those prices with the construction methods and the works schedule proposed.
- 1.19.2. In such cases, Contract Negotiations shall be carried out with the successful bidder before the issue of Letter of Acceptance. In case the bid is front loaded as mentioned above, NATRAX shall negotiate the price and may accept if the bidder offers a discount as 'lump sum price' on total bid price/sub total or discount on specific item rates. No hike on the already quoted item rate shall be accepted during negotiation.
- 1.19.3. In case the contract negotiation is failed in the opinion of the NATRAX, NATRAX shall intimate the same to the bidder in writing and shall invite the second lowest bidder to negotiate the Contract. If this fails, NATRAX shall negotiate with the remaining responsive bidders in order of their relative ranking, subject to the right of the Employer to reject all the bids.
- 1.19.4. NATRAX does not undertake to accept the lowest or indeed any bid.
- 1.19.5. In case required by NATRAX, contract negotiations on other commercial terms and technical related Issues can also be done with the bidders, but no material deviation from the conditions of tender shall be sought or agreed.

#### 1.20. NOTIFICATION OF AWARD BY ISSUANCE OF 'LETTER OF ACCEPTANCE'

- 1.20.1. Prior to the expiry of the period of Bid validity prescribed, NATRAX shall issue to the successful Bidder the "Letter of Acceptance" (LoA) in duplicate, who will return one copy to NATRAX duly acknowledged, accepted and signed by the authorized signatory, within **Three (3) days** of receipt of the same by him.





1.20.2. The issuance of the Letter of Acceptance to the bidder shall constitute an integral part and it will be a binding to the contract. Upon the issuance of the LoA, NATRAX shall encash/redeem/request to extend the EMD amount/validity, as per the conditions of contract.

1.20.3. The time taken between the date of issue of LoA and Notice to Proceed shall not prevent the contractor to mobilize the man power/equipments at site.

#### 1.21. PERFORMANCE BANK GUARANTEE

1.21.1. The Successful Bidder within Fifteen (15) days of the acceptance of the LoA, shall execute a Performance Bank Guarantee as per contract, from a scheduled Bank, for an amount equivalent to the **5% of the accepted Contract Value**, which shall be kept valid for the entire period of work, i.e. till the completion of 30 days after the date of issue of the 'Defect rectification certificate'.

1.21.2. The Performance Bank Guarantee of the successful Bidder will be invoked and forfeited if he fails to comply with any of the conditions of contract.

#### 1.22. ISSUANCE OF 'NOTICE TO PROCEED'

After the acceptance of the LoA and securing PBG from the successful bidder, NATRAX shall issue the 'Notice to proceed' (NTP), to the contractor authorising him to take possession of the allocated project site for pre-construction activities. Further 'NTP' shall be issued to the contractor along with relevant Technical inputs/GFC drawings/Fabrication drawings etc. to commence the construction activities. The time for completion of works as mentioned in the tender will be counted from this date issue of NTP. Refer clause 3 of the GCC for details.

1.22.1. NATRAX shall not entertain any claim, whatsoever, on account of time between the above two NTPs, if sought by the contractor.

#### 1.23. SIGNING OF CONTRACT AGREEMENT

1.23.1. The successful Bidder shall enter into contract and shall execute and sign the Contract Agreement in accordance with the Articles of Agreement, within **Fifty (15) days** from the date of issue of letter of acceptance. But the written acceptance by NATRAX of a Bid will constitute a binding to Contract between NATRAX and the person so tendering, whether such formal agreement is not subsequently executed.

1.23.2. NATRAX shall prepare the draft Articles of Agreement in the Proforma included in this Document, duly incorporating all the terms of agreement between the two parties and send the same in duplicate to the successful Bidder for their concurrence within **Ten (10) days** of the date of receipt of the "Letter of Acceptance" duly acknowledged, accepted and signed by the successful Bidder.

1.23.3. The successful Bidder shall return the duly concurred copies of the draft Articles of Agreement within **Five (5) days** of receipt of the draft Articles of Agreement from NATRAX. Bidder shall prepare two copies of Articles of Agreement in a correct amount of stamp paper, duly adjudicated by the registrar of Stamps, of the State of Madhya Pradesh, where the contract agreement is proposed to be executed and the parties shall execute the contract agreement at the NATRAX, duly signed by the authorized signatories of both the parties. The authorised signature of the bidder shall be





the same person who has signed on the bidding documents on behalf of the bidder, unless the change in the authorised person is notified by the Bidder in writing and a power of attorney is submitted by the bidder in this regard.

- 1.23.4. Further, the authorised person of NATRAX shall sign on all pages of the bidding documents submitted by the successful bidder and execute the complete set of contract agreement. One copy of the executed Articles of Agreement along with the complete set of contract documents shall be issued to the Contractor, within 10 days of execution of contract agreement.

**1.24. RETURNING OF EARNEST MONEY DEPOSIT (BID SECURITY AMOUNT)**

- 1.24.1. The Earnest Money Deposit of the unsuccessful bidders in the *technical Bid evaluation stage* shall be returned along with their up-opened financial bids within 7 days after opening of the eligible financial Bids.

- 1.24.2. The Earnest money Deposit of the unsuccessful bidders in the *financial bid evaluation stage* shall be returned within 7 days, on award of contract to the Successful bidder.

- 1.24.3. The Earnest money deposit of all the bidders shall be returned along with their un-opened financial bids, in case of cancellation of Tender after the opening of Bids and prior to opening of financial bids.

- 1.24.4. The Earnest money deposit of the Successful Bidder will be returned, upon the receipt of the PBG.

**1.25. NATRAX's RIGHT TO ACCEPT /REJECT ANY OR ALL BIDDERS AND DIVIDE THE CONTRACTS**

NATRAX reserves the right to accept / reject or modify any tender, and to annul the tender process and reject all tenders, at any time prior to award of Contract without assigning any reasons, or to divide the Contract between/amongst Bidders without thereby incurring any liability to the affected Bidder or Bidders or any obligations to inform the affected Bidder or Bidders of the grounds for NATRAX's action. The Bidders shall not have any cause of action or claim against NATRAX for rejection of their proposals.

**1.26. PROCESS TO BE CONFIDENTIAL**

- 1.26.1. Except the public opening of Bids, information relating to the examination, clarification, evaluation and comparison of bids and recommendations concerning the award of Contract shall not be disclosed to Bidders or other persons not officially concerned with such process.

- 1.26.2. Any effort by a Bidder to influence NATRAX or any of its functionaries in the process of examination, clarification, evaluation and comparison of tenders and in decisions concerning award of contract, may result in the rejection of the Bid.





Section-4- General Conditions of Contract [GCC]

NATIONAL AUTOMOTIVE TEST TRACKS

## GENERAL CONDITIONS OF CONTRACT





## TABLE OF CONTENTS

1.	DEFINITIONS AND INTERPRETATIONS .....	34
1.1	Definitions.....	34
1.2	Interpretation.....	41
1.3	Record of Measurements and Arithmetic conventions.....	42
1.4	Communications.....	43
1.5	Background Information .....	43
1.6	Joint Ventures.....	45
1.7	Confidentiality.....	45
1.8	NATIS Representative's Instructions.....	47
1.9	Guarantees.....	48
1.10	Detailing.....	49
2.	THE NATIS REPRESENTATIVE .....	49
2.1	The NATIS Representative's duties and authorities.....	49
2.2	NATIS Representative's authority to delegate .....	51
2.3	Duration of powers and authorities .....	51
2.4	NATIS protection.....	51
3.	COMMENCEMENT AND THE NOTICE TO PROCEED .....	52
3.1	Condition Precedent .....	52
3.3	Following the Notice to Proceed.....	52
4.	THE PROJECT SITE.....	53
4.1	Access to and possession of the Project Site.....	53
4.2	Unauthorised persons .....	55
4.3	Rights of possession .....	55
4.4	Additional access and facilities .....	55
5.	CONDITION OF THE PROJECT SITE.....	55





5.1	Information from NATIS .....	55
5.2	Contractor to inspect .....	56
5.3	Claims.....	57
5.4	Fossils and antiquities .....	57
5.5	Property in excavated material .....	58
6.	THE CONTRACTOR .....	58
6.1	The Contractor's general responsibilities.....	58
6.2	The Contractor's representations and warranties .....	59
6.3	Contractor's Documents .....	61
6.4	Design Development .....	64
6.5	Contractor's Guarantee .....	65
7.	SUBCONTRACTORS .....	66
7.1	Subcontracting.....	66
7.2	Subcontractor's Warranty and Assignment of Sub-Contractor's Obligations .....	66
7.3	Responsibility.....	67
7.4	Subcontract Terms.....	67
7.5	Subcontract Management.....	69
8.	SUFFICIENCY OF THE CONTRACT SUM .....	70
9.	COMMENCEMENT OF THE WORKS .....	71
9.1	The Programme .....	71
9.2	"As built" drawings.....	75
9.3	Quality Assurance Plan .....	75
10.	REVIEW MEETINGS .....	75
11.	HEALTH, SAFETY, SECURITY AND ENVIRONMENT.....	76
11.1	Importance of Safety .....	76
11.2	Contractor's Health, Safety, Security and Environment Plan.....	76





11.3	Environmental Compliance.....	77
11.4	Fencing, lighting and guarding.....	78
12.	ELECTRICITY, WATER.....	79
12.1	General arrangements.....	79
13.	RELATED WORKS .....	80
13.1	Acknowledgement.....	80
13.2	Related Works' responsibilities .....	80
13.3	Co-ordination meetings .....	82
13.4	Allowance in the Contract Sum.....	82
13.5	Failure to co-ordinate .....	82
13.6	The NATIS Representative's assistance .....	83
13.7	Contractor to bear costs.....	83
13.8	Contractor's obligations.....	84
13.9	Contractor's indemnities.....	84
13.10	Temporary Works.....	84
14.	DELIVERY TO THE PROJECT SITE.....	84
14.1	Delivery to the Project Site.....	84
14.2	Packing List.....	85
14.3	Importation.....	85
14.4	Customs Clearance.....	85
14.5	Documents.....	85
15.	CONTRACTOR'S EQUIPMENT AND OTHER PROVISIONS .....	86
15.1	Contractor's Equipment and Temporary Works .....	86
15.2	NATIS not liable for damage .....	86
15.3	Conditions of hire of Contractor's Equipment.....	86





15.4	Hire purchase payments by NATIS.....	87
15.5	Re-export of Contractor's Equipment.....	87
15.6	Approval not implied.....	87
15.7	Incorporation of Clause into Subcontracts .....	88
15.8	Revesting and removal of Contractor's Equipment .....	88
16.	LABOUR AND CONTRACTOR'S PERSONNEL .....	88
16.1	Labour Compliances.....	88
16.2	Contractor to indemnify .....	90
16.3	Engagement of Labour .....	91
16.4	Project Site records and returns.....	91
16.5.	Contractor's Personnel .....	91
17.	TESTING / INSPECTION .....	95
17.1	General .....	95
17.2	Testing Costs .....	96
17.3	Project Site Tests.....	96
18.	TIME FOR COMPLETION, RATE OF PROGRESS AND ACCELERATION.....	97
18.1	Time for Completion.....	97
18.2	Rate of progress.....	97
18.3	Acceleration.....	98
19.	EXTENSION OF TIME FOR COMPLETION .....	100
19.1	Contractor's notice of event likely to cause delay.....	100
19.2	Reasons for delay and extension of time.....	100
19.3	Further particulars .....	101
19.4	Delay Events.....	102
19.5	NATIS Representative to determine extension .....	102
19.6	Compliance.....	103





19A.	PROCEDURE FOR CLAIMS .....	104
19A.1	Notice of claims.....	104
19A.2	Contemporary records .....	104
19A.3	Substantiation of claims .....	105
19A.4	Monthly particulars .....	105
19A.5	Payment of claims .....	105
20.	LIQUIDATED DAMAGES .....	106
20.1	Liquidated Damages for delay.....	106
20.2	Payment of Liquidated Damages.....	106
20.3	Genuine Pre-estimate of Damages .....	107
20.4	Payment of Bonus on early completion of works	
64		
21.	COMPLETION OF WORKS.....	107
21.1	Completion of Works .....	107
21.2	Application for and issue of the Completion Certificate .....	107
21.3	Completing Punch List Items and any other outstanding works .....	108
21.4	Completion of parts .....	109
22.	RECTIFICATION OF DEFECTS AND MAINTENANCE OF THE PERMANENT WORKS.....	109
22.1	Defects rectification by the Contractor.....	109
22.2	Defects Rectification Certificate .....	110
22.3	Continuing Obligations .....	110
22.4	Endemic Failures.....	111
22.5	Liability for Latent Defects .....	112
22.6	Maintenance Obligations.....	112
23.	CHANGES .....	112
23.1	General .....	113
23.2	Procedure for Changes .....	113





23.3	Contractor's Changes.....	115
23.4	Omissions.....	116
23.5	Valuation of Changes.....	117
23.6	Dayworks.....	118
24.	INTELLECTUAL PROPERTY.....	119
24.1	Intellectual Property.....	119
24.2	Unique Copyright.....	119
24.3	Infringing Matter.....	119
25.	INSURANCES.....	121
25.1	Project Facility Insurances.....	121
25.2	Contractor Insurances.....	121
25.3	Required Insurances.....	122
25.4	Evidence.....	122
25.5	Compliance.....	122
25.6	Premiums.....	123
25.7	Deductibles and application of insurance proceeds.....	123
26.	PAYMENT.....	123
26.1	Payment Schedule.....	123
26.2	Contractor's Application for Payment.....	123
26.3	Certificates of Payment.....	125
26.4	Payment.....	127
26.5	Final Payment.....	127
26.6	Disbursal of Final Payment.....	128
26.7	Mode of Payment.....	128
26.8	Corrections to Certificates of Payment.....	128
26.9	Currency of Payment.....	129
26.10	NATIS right to set off.....	129





26.11	Advance Payment.....	129
26.12	Effect of Payment.....	129
27.	TAXES AND DUTIES .....	130
27.1	Contractor to pay Taxes.....	130
27.2	Withholding Tax/Income Tax deducted at source.....	131
27.3	Exemptions and Concessions .....	131
27.4	General .....	131
28.	NATIS .....	132
28.1	NATIS obligations .....	132
29.	CONTRACTOR'S COVENANTS .....	132
29.1	Setting Out And Boreholes.....	132
29.2	Urgent repairs.....	133
29.3	Increased Monitoring and Right to Open Up .....	134
29.4	Improper work.....	135
29.5	Suspension.....	135
29.6	Audit.....	137
29.7	Illegal gratification .....	138
29.8	Avoidance of Damage to Roads and Bridges.....	139
29.9	Care of the Works, Liability for Accidents and Damage .....	140
29.10	Clearance of the Project Site .....	142
30.	FORCE MAJEURE.....	142
30.1	Force Majeure - Obligations of the Parties.....	142
30.2	Meetings with NATIS Representative.....	143
30.3	Reporting during the Force Majeure Period.....	143
30.4	Performance obligations.....	143
30.5	Liability for other losses, damages etc. ....	144



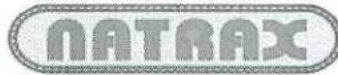

30.6	Exceptions to Force Majeure.....	144
31.	DISPUTE RESOLUTION PROCEDURE.....	144
31.1	Amicable Resolution and Mediation.....	144
31.2	Arbitration Procedure.....	145
31.3	Place of Arbitration .....	145
31.4	English Language.....	145
31.5	Enforcement of Award .....	145
31.6	Performance during Arbitration .....	145
32.	REPRESENTATIONS AND WARRANTIES, DISCLAIMER.....	145
32.1	Representations and Warranties of the Contractor.....	145
33.	TERMINATION .....	147
33.1	Termination .....	147
33.2	Termination Procedure.....	149
33.3	Upon Termination .....	150
34.	MISCELLANEOUS.....	151
34.1	Assignment and Charges.....	151
34.2	Interest.....	151
34.3	Governing Law and Jurisdiction .....	151
34.4	Waiver .....	152
34.5	Survival .....	152
34.6	Amendments.....	152
34.7	Severability.....	152
34.8	No Partnership.....	153
34.9	Exclusion of implied warranties.....	153
34.10	Entire Agreement .....	153
34.11	Liability and Indemnity .....	153







## GENERAL CONDITIONS OF CONTRACT

### 1. DEFINITIONS AND INTERPRETATIONS

#### 1.1 Definitions

In these Conditions of Contract (“**Conditions**”) the following words and expressions shall, unless repugnant to the context or meaning thereof, have the meaning hereinafter respectively ascribed to them:

“Additional Cost” means the additional capital expenditure and/or the additional operating cost or additional taxes or all as the case may be, which the Contractor has or would be required to incur and which has arisen as a result of Change of Scope.

“Advance Payment” means a sum equal to the amount named in Special Conditions of Contract and paid to the Contractor by NATIS by way of a mobilisation/advance payment in accordance with **Clause 26.11.1** [Advance Payment].

“Advance Payment Guarantee” means any or all of the guarantees to be procured in accordance with **Clause 26.11** [Advance Payment].

“Affected Party” means a Party whose performance of its obligations under the Contract is prevented, hindered or delayed in whole or in part by reason of Force Majeure.

“Applicable Clearances” means any clearance, permit, authorisation, consent, licence (including without limitation, any import or export licences), lease, ruling, exemption, filing, agreements, or approval, required to be obtained and maintained by NATIS and/or the Contractor from time to time, in order to implement the Project Facility and/or to design and Execute the Works in accordance with the Contract.

“Applicable Laws” means all laws in force and effect as of the date hereof and which may be promulgated or brought into force and effect hereinafter in India including any revisions, amendments or re-enactments including without limitation rules, regulations and notifications made there under and judgments, decrees, injunctions, writs, orders and notifications issued by any court of record or any appropriate authorities, as may be in force and effect during the subsistence of the Contract.

“Arbitration Act” means the Arbitration and Conciliation Act, 1996 and shall include any amendment to or any re-enactment thereof as in force from time to time.

“As-built Documents” means all as-built documents and information of the completed Project Facilities.

“Audit Period” shall have the meaning given under **Clause 30.6.4** [Audit Rights].

“Background Information” means all and any materials, data, documents, drawings, plans, surveys, reports or other information of whatsoever nature and howsoever prepared/stored relating in any way to the Project Facility made available by NATIS and/or its agents in connection with the Contract and/or discussions which preceded such negotiations and preparations, including all such materials, data, documents, drawings, plans, agreements or other information provided in connection with those processes.

“Business Day” means a day other than a Sunday or a public holiday on which banks are open for domestic business in the city of New Delhi.

“Certificate of Payment” means the certificate referred to as such in **Clause 26.3** [Certificate of Payment].





“Change” means any change to Technical Specifications and Drawings, which is instructed or approved as a Change under **Clause 23 [Changes]**.

“Change Notice” shall have the meaning ascribed to it in **Clause 23.2.1(i) [Procedure for Changes]**.

“Change Notice Response” shall have the meaning ascribed to it in **Clause 23.2.2 [Procedure for Changes]**.

“Change Order” shall have the meaning ascribed to it in **Clause 23.2.4 [Procedure for Changes]**.

“Completion Certificate” has the meaning ascribed to it in **Clause 21.4 [Application for and issue of the Completion Certificate]**.

“Completion of the Works” means the achievement of the criteria set out in **Clause 21.3.1 [Completion of the Works]** and “Complete” “Completed” “Completion” and “Completing” shall be construed accordingly and as certified by the Completion Certificate.

“Confidential Information” means the Contract and everything contained therein, all documentation, data, particulars of the Works and/or the Project Facility and/or the Project and technical or commercial information made by (or on behalf of) NATIS or obtained directly or indirectly from NATIS Representative by the Contractor or which is generated by the Contractor or any subcontractor or any information or data that the Contractor receives or has access to as a result of the Contract, other than information:

- (a) which is generally available in the public domain other than by any unauthorised actions or fault of the Contractor; or
- (b) which is in the possession of the Contractor with a right to disclose; or
- (c) Proprietary Information.

“Contract” means the Contract Agreement, these Conditions, Special Conditions of Contract, Technical Specifications and Drawings, the Schedules, and the further documents (if any) which are listed in the Contract Agreement and initialled by NATIS and the Contractor and includes any amendment thereto made in accordance with the provisions hereof.

“Contract Agreement” means the agreement entered into or to be entered into by the Parties and forming part of the Contract.

“Contract Price” means the Contract Sum subject to such additions thereto or deductions there from as made in accordance with the Contract.

“Contract Sum” means the sum stated in Special Conditions of Contract and as payable to the Contractor for the design and Execution of the Works in accordance with the provisions of the Contract.

“Contractor” shall mean the person specified in the Contract Agreement as the Contractor.

“Contractor's Documents” means those documents to be prepared by the Contractor under the Contract including without limitation, such technical documents specified in Technical Specifications and Drawings and such data, drawings, designs, design information, detailed drawings and designs, descriptions, calculations, schedules, specifications, plans, samples, patterns, models, mock-ups, computer software drawings, inspection and test plans, manuals, programmes test data and all other information and documents including all eye





readable or computer or other machine readable data relating to the design or Execution of the Works or otherwise to performance of the Contract.

“Contractor’s Equipment” means all or any apparatus, machinery, equipment, vehicles, materials, plant, tools and all other things required for the Execution of the Works and the remedying of any defects to be provided by the Contractor but Contractor’s Equipment excludes Temporary Works, Equipment and any other things intended to form or forming part of the Permanent Works.

“Contractor’s Health, Safety, Security and Environmental Plan” means that plan referred to in Clause 11.2 [Contractor’s Health, Safety, Security and Environment Plan].

“Contractor’s Insurances” means the insurance policies to be purchased and maintained in full by the Contractor, in respect of the risks set out in the contract.

“Date of Completion of the Works” means the date certified as such in the Completion Certificate in accordance with Clause 21.3 [Completion of Works].

“Day work Schedule” means the day work schedule which is prepared and priced by the Contractor in respect of the Works and included in Schedule B [Schedule of Prices].

“Default Interest Rate” shall be the interest rate per annum set out in Special Conditions of Contract.

“Defects Rectification Certificate” means the certificate to be issued in accordance with Clause 22.2 [Defects Rectification Certificate].

“Defects Rectification Period” means the period stated in Special Conditions of Contract.

“Delay Event” means any event set out at Clause 19.4 [Delay Events].

“Design Requirements” means the design requirement of the Project/Project Facility set forth in the Technical Specifications and Drawings.

“Detailed Project Implementation Report” means the Detailed Project Implementation Report prepared by consultants of NATIS and setting out the manner of procurement of the Works for the Project Facility and the completion of the Project.

“Dispute” shall have the meaning ascribed thereto in Clause 31.1 [Amicable Resolution and Mediation].

“Dispute Resolution Procedure” means the procedure for resolution of Disputes set forth in Clause 31 [Dispute Resolution Procedure].

“Drawing or Drawings” means all of the drawings, designs, calculations and documents pertaining to the Project in accordance with the Design Requirements.

“Effective Date” means the date of execution of the Contract by the Parties.

“Emergency” means any condition or situation that will or is likely to endanger safety as per Good Industry Practice on or about the Project Site and/or the Permanent Works including safety of users thereof or which poses or is likely to pose an immediate threat of material damage to any part of the Project Site and/or the Permanent Works.

“Encumbrance” means any encumbrance such as mortgage, charge, pledge, lien, hypothecation, security interest, assignment, privilege or priority of any kind having the effect of security or other such obligations and shall include without limitation any designation of loss payees or beneficiaries or any similar arrangement under any insurance





policy pertaining to the Project Facility and/or the Works, physical encumbrances and encroachments on the Project Site and/or the Permanent Works.

“Execution of the Works” means the construction, procurement and supply of materials for construction, testing and completion of the Works and the correction of defects in the Works and all works and things required to be undertaken pursuant to the Contract and “Executed”, “Execute” and “Execution” shall be construed accordingly.

“Execution Period” means the period beginning from the date of issue of the Notice to Proceed and ending on the Date of Completion of the Works.

“Final Design” means any design in accordance with which the Contractor may proceed pursuant to Clause 6.3.12 [Contractor’s Documents] with the commencement of the Execution of the relevant part of the Works.

“Final Request for Payment” shall have the meaning ascribed to it in Clause 26.5.1 [Final Payment].

“Force Majeure” shall have the meaning ascribed thereto in Clause 31.6 [Force Majeure]

“Force Majeure Period” means, the period commencing from the date of occurrence of a Force Majeure and ending on the date on which the Affected Party, acting in accordance with the Good Industry Practice, resumes or should have resumed such of its obligations the performance of which was excused in accordance with the Contract.

“GoI” means the Government of India and includes any agency, authority (including any regulatory authority) department, inspectorate, ministry or statutory person (whether autonomous or not) under the control and direction of the Government of India.

“Good Industry Practice” means the exercise of the highest degree of skill, diligence, prudence and foresight in compliance with the undertakings and obligations under the Contract which would be expected from a skilled and experienced person engaged in the planning, design, execution, testing, implementation, operation and maintenance or supervision or monitoring thereof or any of them of works of the type, nature and scope similar to that of the Works.

“Goods” means Contractor’s Equipment, Materials and Temporary Works, or any of them as appropriate.

“Gross Certifiable Amount” has the meaning ascribed to it in Clause 26.3.1 [Certificates of Payment].

“Guarantee Period” shall have the meaning ascribed to it in Clause 6.5.1 [Contractor’s Guarantee] and which shall be specified in the Special Conditions of Contract.

“Initial Programme” shall have the meaning ascribed to it at Clause 9.1.2 [The Programme].

“Intellectual Property” means copyright, all rights conferred under statute, common law or equity in relation to inventions (including patents), registered and unregistered trademarks and service marks, registered and unregistered designs, circuit layouts, confidential information, proprietary information and all other rights resulting from intellectual activity in the industrial, scientific, literary or artistic fields.

“Key Personnel” shall have the meaning ascribed thereto in Clause 16.5.3 [Key Personnel].

“Latent Defect” means any work or repair, amendment, reconstruction, rectification, defect, imperfection or other fault which only becomes apparent to NATIS following the expiry of the Defects Rectification Period and which is due to the use of materials or workmanship not





in accordance with the Contract or the neglect or failure of the Contractor to comply with any of its obligations, express or implied, under the Contract.

“Latent Defects Rectification Period” means the period stated in the Special Condition of Contract calculated from the date of issue of the Completion Certificate.

“Liquidated Damages” means those damages provided by Special Conditions of Contract to be paid or allowed by the Contractor to NATIS as compensation for delay pursuant to Clause 20 [Liquidated Damages].

“Material Adverse Effect” means Material Adverse Effect on (a) the ability of Contractor to exercise any of its rights or perform/discharge any of its duties/obligations under and in accordance with the provisions of this Contract and /or (b) the legality, validity, binding nature or enforceability of this Contract.

“Materials” shall mean all construction materials including but not limited to all items required to be incorporated in the Works, for construction and completion of the Works and set out in the Technical Specifications and Drawings.

“Master Plan” means the plan defining the layout of the Project Facility within the Project Site and in conformity with the Detailed Project Implementation Report to be prepared by NATIS.

“Milestone Event” means the completion of a specific activity and shall include the extent of progress of works (if any) as specified in the Special Conditions of Contract, to be achieved, which reflects progress in the design and Execution of the Works or the occurrence of an event in each case as identified as such in the Payment Schedule.

“Notice to Proceed” means the notice to be issued by NATIS to the Contractor pursuant to Clause 3 [Commencement and Notice to Proceed].

“NATIS” shall mean the National Automotive Testing and R&D Infrastructure Project Implementation Society or its successors or assigns.

“NATIS Representative” means the person, company or firm appointed by NATIS to act as its representative and the Engineer In-Charge for the purposes of the Contract and named as such as in Special Conditions of Contract or such other person, company or firm so appointed from time to time by NATIS and notified in writing as such as such to the Contractor.

“Parties” means NATIS and the Contractor and “Party” means any one of those Parties.

“Payment Schedule” means the payment schedule described as such and set out at Schedule C [Payment Schedule].

“Performance Guarantee” means the guarantee to be procured in accordance with Clause 1.9.1 [Guarantees].

“Performance Standards” means such performance standards for the operation and maintenance of the Project Facility as may be applicable pursuant to the Contract.

“Permanent Works” means the permanent works to be Executed (including without limitation, all structures and all work intended to form a continuing function after Completion) and any other work contractually required to be left at the Project Site after Completion in accordance with the Contract.





“Price Breakdown” means the price breakdown of the elements of the Works prepared by the Contractor for the purposes of the Contract and set out at Schedule B [Schedule of Prices].

“Programme” shall have the meaning ascribed to it at **Clause 9.1.5** [The Programme].

“Project” means the National Automotive Testing Track NATRAX.

“Project Facility” shall mean facility being one or more of the following facilities as specified in the Special Conditions of Contract, being developed in accordance with the Project and the Detailed Project Implementation Report and includes all its buildings, equipment, facilities, software and systems and includes without limitation, where the circumstances so require, any expansion thereof from time to time and may include any new location to be separately mentioned in the Special Conditions of Contract.

- (i) A full-fledged testing and homologation centre within the northern hub of automotive industry at Manesar, Haryana;
- (ii) A full-fledged testing and homologation centre within the southern hub of automotive industry at a location at Oragadam, near Chennai, Tamil Nadu;
- (iii) Upgradation of existing testing and homologation facilities at Automotive Research Association of India (ARAI), Pune, Maharashtra;
- (iv) Upgradation of existing testing and homologation facilities at Vehicle Research and Development Establishment (VRDE), Ahmednagar, Maharashtra;
- (v) World-class proving grounds or testing tracks on around 4,000 acres of land, at Pithampur, near Indore, Madhya Pradesh;
- (vi) National Centre for Testing of Tractors and Off-Road Vehicles together with national facility for accident data analysis and specialized driving training in northern part of the country at Rae Bareilly, Uttar Pradesh;
- (vii) National Specialized Hill Area Driving Training Centre as also Regional In-Use Vehicle Management Centre at Dholchora (Silchar), Assam.

“Project Facility Insurance” means the insurance policies to be purchased and maintained in force by NATIS, in respect of risks set out in the contract.

“Project Manager” shall have the meaning ascribed thereto in **Clause 16.5.3.2 (i)** [Key Personnel].

“Project Site” means that part of the site as indicated in the Special Conditions of Contract, on, under and over which the Permanent Works are to be Executed and any site to which any Contractor's Equipment, Materials and Temporary Works are to be delivered and any other places as may be specified in the Contract as forming part of the Project Site.

“Project Site Tests” means tests described as such in the Testing Plans.

“Proprietary Information” shall have the meaning ascribed thereto in **Clause 1.7.2(vi)(b)** [Proprietary Information].

“Punch List Items” means items of works of a minor or snagging nature which do not affect beneficial occupation or use of the Works by NATIS, or other users and, where agreed with NATIS, any other works which remain incomplete at the Date of Completion of the Works.





“Provisional Sum” means a sum included in the Contract and so designated in the Bill of Quantities for the execution of any part of the Works or for the supply of goods, materials, Plant or services, or for contingencies, which sum may be used, in whole or in part, or not at all, on the instructions of the NATIS Representative. The Contractor shall be entitled to only such amounts in respect of the work, supply or contingencies to which such Provisional Sums relate as the NATIS Representative shall determine in accordance with this Clause. The NATIS Representative shall notify the Contractor of any determination made under this Sub-Clause, with a copy to the NATIS.

“Provisional Sum Works” means those parts of the Works designated in Special Conditions of Contract as to be performed against expenditure of a Provisional Sum.

“Quality Assurance Plan” means that plan referred to in **Clause 9.3** [Quality Assurance Plan].

“Related Works” means works other than the Works, performed or undertaken by NATIS or other contractors or suppliers of NATIS or any contractor employed in connection with the Project Facility and/or services related thereto or by public or private utilities or by any Statutory Authority or other authorities or by any Relevant Authority, either prior to, concurrently or sequentially with the Works at, on, over or adjacent to the Project Site in connection with or related to the Project Facility and which may be connected to, associated with, ancillary to or otherwise related to or relevant to the Works.

“Related Works Contractor” means any person or persons undertaking Related Works.

“Relevant Authority” includes the GoI, Department of Customs and Excise, the Ministry of Finance, the Department of Heavy Industry, Ministry of Heavy Industries and Public Enterprises or any other subdivision or instrumentality thereof, any local authority, or any authority empowered by the Applicable Laws.

“Request for Payment” means the request for payment issued by the Contractor in accordance with **Clause 26.2.2** [Contractor’s Application for Payment].

“Required Insurances” means collectively the Project Facility Insurances and the Contractor Insurances.

“Retention Amount” means that part of the payment of the Contract Sum to be retained by NATIS in accordance with **Clause 1.9.5** [Guarantees].

“Review Meeting” has the meaning ascribed to it at **Clause 10.1** [Review Meetings].

“Review Period” has the meaning ascribed to it in **Clause 6.3.2** [Contractor's Documents].

“Schedules” means Schedules attached to the Special Conditions of Contract.

“Schedule of Prices” means the schedule identified as such at Schedule B [Schedule of Prices].

“Special Conditions of Contract” means the document titled Special Conditions of Contract as included in the Contract, which are compliment to GCC in accordance with the Contract. Such document specifies any special terms and conditions forming part of this Contract and shall be read along with these Conditions when referring to the Contract.

“Statutory Authority” means GoI, or any central or state government or governmental department, commission, board, body, bureau, agency, authority or any companies owned by GoI, instrumentality, court or other judicial or administrative body, central, state, or local body or any other authority empowered by Applicable Laws, having jurisdiction over the





Parties, the Project Facility and/or Works and facilities or any portion thereof, or the performance of all or any of the service or obligations of the Parties.

“Subcontractor” means a Subcontractor to whom a part of the Works has been subcontracted or to whom the supply of any goods or materials or labour and services for the Works has been subcontracted as permitted under **Clause 7 [Subcontractors]** and the permitted legal successors in title to such person, but not any assignee of such person.

“Tax” means all forms of taxation, duties, fees, imposts and levies including (but without limitation) GST, income tax including withholding tax, value added tax, service tax, octroi, entry tax, corporation profits tax, advance corporation tax, capital gains tax, residential and property tax, customs and other import and export duties, excise duties, stamp duty, capital duty, social insurance, social welfare or other similar contributions and other amounts corresponding thereto and any interest, surcharge, penalty or fine in connection therewith which may be payable worldwide by the Contractor, its Subcontractors and any of their employees, and the words “Taxation” and “Taxes” shall be construed accordingly.

“Technical conditions of contract” means the document entitled Technical Specifications and Drawings, as included in the Contract, and any additions and modifications to such document in accordance with the Contract. Such document specifies the purpose, scope, and /or design and specifications and /or other technical criteria for the Works.

“Temporary Works” means all works required in or about the Execution of the Works other than the Permanent Works and the Contractor’s Equipment.

“Termination Date” means the date specified in the notice of Termination given by either Party to the other Party, from which the Contract shall stand terminated, in accordance with the Clause 34.2.2 of this Contract.

“Termination Notice” means the notice of Termination given by either Party to the other Party, in accordance with Clause 34.2.2 of this Contract.

“Testing Plans” means those plans included in the Quality Assurance Plan and referred to in **Clause 17.1.2 [General]** which set out the tests and inspections required to be performed by the Contractor in accordance with the Technical Specifications and Drawings and the means by which the Contractor intends to conduct and satisfy such tests and inspections.

“Time for Completion” means the time for Completion of the Works as stated in Special Conditions of Contract or such time as may be varied from time to time in accordance with the Contract, calculated from the Date of issue of the Notice to Proceed.

“Works” means the Permanent Works and the Temporary Works or any part thereof.

## 1.2 Interpretation

In the Contract, unless the context otherwise requires or as otherwise expressly stated:

- 1.2.1 any reference to a statutory provision shall include such provision as is from time to time modified or re-enacted or consolidated so far as such modification or re-enactment or consolidation applies or is capable of applying to any transactions entered into hereunder;
- 1.2.2 the words importing singular shall include plural and vice versa, and words denoting natural persons shall include partnerships, firms, companies, corporations, joint ventures, trusts, associations, organisations or other entities (whether or not having a separate legal entity);





- 1.2.3 the headings are for convenience of reference only and shall not be used in, and shall not affect, the construction or interpretation of this Contract;
- 1.2.4 the words “include” and “including” are to be construed without limitation;
- 1.2.5 any reference to any period of time shall mean a reference to that according to Indian Standard Time;
- 1.2.6 any reference to day shall mean a reference to a calendar day;
- 1.2.7 any reference to month shall mean a reference to a calendar month;
- 1.2.8 the Special Conditions of Contract, the Technical Specifications and Drawings and Schedules form an integral part of the Contract and will be in full force and effect as though they were expressly set out in the body of these Conditions. Terms defined in the Special Conditions of Contract, Technical Specifications and Drawings and Schedules shall have the same meaning throughout the Contract. In case of any conflict between these Conditions and the Special Conditions of Contract, the latter shall prevail;
- 1.2.9 any reference at any time to any contract, deed, instrument, license or document of any description shall be construed as reference to that contract, deed, instrument, license or other document as amended, varied, supplemented, modified or suspended at the time of such reference;
- 1.2.10 references to recitals, **Clauses**, sub-**Clauses**, clauses, or Schedules in the Contract shall, except where the context otherwise requires, be deemed to be references to recitals, **Clauses**, sub-**Clauses**, clauses and Schedules of or to this Contract;
- 1.2.11 unless otherwise stated, any reference to any period commencing “from” a specified day or date and “till” or “until” a specified day or date shall include both such days or dates;
- 1.2.12 definitions within **Clauses** have the meaning ascribed thereto.
- 1.2.13 the words “tender” shall be synonymous with the word “bid” and the words “tender documents” with the words “bidding documents”.



**1.3 Record of Measurements and Arithmetic conventions**



1.3.1 The records of measurements such as measurement books, level books or any other such records shall be under the custody of the NATIS Representative and the Engineer In-charge and he/his authorised representative shall make entries of the measurements in the relevant records, conducted jointly by NATIS and the Contractor and the records are required to be signed by the both parties. These measurement records shall be referred to by the contractor, along with the relevant, accepted / closed RFIs/RITs as per clause 17.1.4, to prepare and submit his request for payment.

1.3.2 All measurements and calculations shall be in metric system and the rounding off of the contents/quantities to the requisite decimal place shall be done based on the relevant IS codes.

#### 1.4 Communications

1.4.1 Wherever these Conditions provide for any agreement, or the giving or issuing of any consent, approval, authorisation, notice, certificate, request, determination, information or report ("communication") from or by any Party or NATIS Representative such communication shall be valid and effectual only if:

- (i) in writing under the hands of a duly authorised representative of such Party or NATIS Representative, as the case may be and delivered by hand (against receipt), sent by recognised courier, registered mail, or transmitted by facsimile transmission; and
- (ii) delivered, sent or transmitted to the address for the recipient's communications as stated in Special Conditions of Contract.

1.4.2 All notices required to be given under the Contract and all communications, documentation and proceedings which are in any way relevant to the Contract shall be in the English language.

#### 1.5 Background Information

1.5.1 NATIS gives no warranty or undertaking as to the completeness, accuracy or fitness for purpose of any of the Background Information or the various documents that together comprise the Contract or for any representation or statement contained therein. Neither NATIS nor any of its agents or servants shall be liable to the Contractor in contract, tort (including negligence or breach of statutory duty) statute or otherwise as a result of:

- (i) any inaccuracy, omission, unfitness for purpose or inadequacy of any kind whatsoever in the Background Information;





- (ii) any failure to make available to the Contractor any materials, documents, drawings, plans or other information relating to the Works or the Project Facility ;
- (iii) any ambiguities, discrepancies, inconsistencies, divergences, design or construction impracticalities or omissions from, within, or between the documents which comprise the Contract.

1.5.2 In this regard, the Contractor represents and warrants to NATIS that:

- (i) it has conducted its own analysis and review of the Background Information and that it has satisfied itself as to the accuracy, fitness for purpose and completeness of all such Background Information; and
- (ii) it has thoroughly examined and discussed the Technical Specifications and Drawings with NATIS at length and has thoroughly examined the documents comprising the Contract and is satisfied that there are no ambiguities, discrepancies, inconsistencies, divergence, design or construction impracticalities or omissions from, within and between such documents and that such documents are accurate, complete, technically feasible and sufficient in all respects for the purposes of the execution of the Works and that it has consequently agreed to accept full responsibility for the designs and specifications for the Works whether comprised in the Technical Specifications and Drawings or the Contractor's bid; and
- (iii) after a complete and careful examination, it has made an independent evaluation of the scope of the Works required and has determined and fully acquainted itself with the nature and extent of the difficulties, the risks and hazards, including without limitation the interfaces and its co-ordination obligations relating to Related Works Contractors, that are likely to arise or may be faced by it in or about of the performance of all its obligations in the Contract and that the same have been taken into account in the programme, the Time for Completion, the Contract Price and all other considerations as to time and cost. The Contractor hereby acknowledges its responsibility in respect of all such difficulties, risks and hazards and agrees that NATIS shall not be liable in respect of the same in any manner whatsoever to the Contractor whether in contract, tort (including negligence or breach of statutory duty) or otherwise; and
- (iv) that there is no ambiguity, discrepancy, inconsistency, divergence between the Technical Specifications and Drawings, the Contractor's bid and the Project Site; and
- (v) having carefully considered all aspects of the Works, including the designs, specifications, scope of work, methodologies, programmes and cost plans and all of the Background Information and having carried out all necessary checks, investigations and enquiries of its own, the design and execution of the Works is





capable of being carried out and completed to the standards required by the Contract by the Time For Completion at a cost not exceeding the Contract Price.

1.5.3 The Technical Specifications and Drawings shall remain in the sole custody of the NATIS Representative but two copies thereof shall be furnished to the Contractor free of charge. The Contractor shall provide and make at its own expense any further copies required by it. At the completion of the Contract the Contractor shall return to the NATIS Representative, the Technical Specifications and Drawings provided under the Contract.

## 1.6 Joint Ventures

1.6.1 The Contractor shall not constitute a joint venture, consortium or other unincorporated grouping of two or more persons (under the Applicable Laws or any equivalent laws) or enter into any partnering or profit sharing arrangements for the design (to the extent required under the Contract) and Execution of the Works, without the prior written consent of NATIS.

## 1.7 Confidentiality

1.7.1 The Contractor shall disclose to NATIS any Confidential Information and other information as NATIS may reasonably require for verifying the Contractor's compliance with the Contract. Further, the Contractor shall not, without the previous written consent of NATIS, use, copy, publish, disclose or otherwise deal with, nor cause nor permit its Subcontractors or any persons for whom it is contractually or otherwise responsible for, to use, copy, publish, disclose or otherwise deal with any Confidential Information, otherwise than for the performance of its obligations under the Contract.

1.7.2 Without limiting the generality of the foregoing:

- (i) the Contractor shall take all practicable steps to ensure that no photographs, drawings or other image of the Project Site or of the Works or any part thereof or any property of NATIS or any physical or virtual model thereof, are taken or made, except as may be expressly provided in the Technical Specifications and Drawings or as may otherwise be directed or approved by the NATIS Representative;
- (ii) the Contractor shall not in regard to anything concerning the Works publish any information, drawing or photograph and shall not give interviews to the press or to any person associated with the news media or take part in radio or television schedules except with the written consent of NATIS Representative and subject to such conditions as it may prescribe;





- (iii) if the Contractor receives enquiries from press, radio or television bodies or representatives or other persons associated with the news media concerning the Works or the Contract it shall refer them to NATIS Representative;
- (iv) the Contractor shall not use any part of the Project Site for the purpose of any advertisement, except by way of notice boards approved by the NATIS Representative as to their form, content, size, number and location; and
- (v) the Contractor shall use its best endeavours to procure that its servants and agents and all Subcontractors, their servants and agents comply with this **Clause 1.7 [Confidentiality]**.
- (vi)
  - (a) the Contractor shall neither disclose any Proprietary Information nor use Proprietary Information other than on NATIS's behalf except as NATIS may otherwise authorise in writing. If disclosure to a third party is so authorised, the Contractor shall enter into a confidentiality agreement with said party containing the same terms and conditions with respect to use or disclosure of Proprietary Information as set forth below. The provisions of this **Clause 1.7[Confidentiality]** shall survive any termination of this Contract.
  - (b) "Proprietary Information"

As used in this **Clause 1.7[Confidentiality]** "Proprietary Information" shall mean all information which the Contractor, directly or indirectly, acquires from NATIS or its affiliates and subsidiaries or from the performance of the Works or any other information concerning the technical and business activities and know-how of NATIS or its affiliates and subsidiaries, except information falling into any of the following categories:

- (1) information which, prior to the time of disclosure hereunder, is lawfully in the public domain;
- (2) information which, after disclosure hereunder, enters the public domain, except where such entry is the result of Contractor's breach of this Contract;
- (3) information, other than that obtained from third parties which, prior to disclosure hereunder, was already lawfully in Contractor's possession either without limitation on disclosure to others or which subsequently becomes free of such limitation; and





- (4) information obtained by Contractor from a third party who is lawfully in possession of such information and not subject to a contractual or fiduciary relationship to NATIS or any of its affiliates or subsidiaries with respect to said information.

1.7.3 The Contractor shall not and shall procure that its Subcontractors do not use the name "NATRIP" or any name which is likely to be confused with that name, or any image of the proposed new Project Facility in any manner or for any purpose whatsoever and shall not disclose to any third party the fact of the Contract, or any of the details hereof or that the Contractor has agreed to undertake the obligations herein referred to. The Contractor shall not use any device registered or used by NATIS whether alone or in a combination with the words "NATRIP" and shall not apply anywhere in the world for a trade mark or similar registration including the words "NATRIP" or any device used or registered by NATIS nor apply anywhere in the world for any trade mark or similar registration that is deceptively similar to the words "NATRIP" or any device used or registered by NATIS nor apply anywhere in the world for any trade mark or similar registration which may cause confusion as to the ownership of such trade marks or similar rights on the part of the public. The Contractor acknowledges that damages alone would be an inadequate remedy for any breach of this **Clause 1.7.3 [Confidentiality]** and that NATIS should, therefore, be entitled to injunctive relief. The Contractor shall indemnify NATIS in respect of any and all loss, damage, costs, liabilities and expenses incurred in taking such action.

1.7.4 Notwithstanding the provisions of **Clause 1.7.3 [Confidentiality]**, NATIS may in its absolute discretion allow or instruct the Contractor in writing to use and/or permit named Subcontractors to use the name "NATRIP", any image of the Project Facility, the fact of its or their involvement in the Project, any device registered or used by NATIS whether alone or in combination with the words "NATRIP" and/or any trade marks registered in the name of NATIS, for a consideration to be agreed and on the terms and for purposes specified in an intellectual property licence.

1.7.5 The Contractor shall reasonably assist NATIS (including with the provision of documentation, evidence and witnesses) with any action taken or to be taken by NATIS against any Subcontractor and/or agent of the Contractor for the alleged wrongful use of the "NATRIP" name, or any name which is likely to be confused with that name or any image of the Project Facility in any device registered or used by NATIS or the registration of any trademark.

## 1.8 NATIS Representative's Instructions

1.8.1 All instructions given by NATIS Representative or by any person executing delegated functions under **Clause 2.2 [NATIS Representative's authority to delegate]** will be issued in writing and in such form as will be advised to the Contractor after the Effective Date. If an instruction is not so issued, the Contractor shall immediately request in writing, a confirmation of the instruction. The Contractor shall not carry out such instruction until NATIS Representative issues a written confirmation of the same, provided that if such confirmation is not received in writing by the Contractor within [4 (four)] Business Days of issue of the Contractor's request for confirmation, such instruction shall be deemed to have been issued in writing and the Contractor shall carry out such an instruction. Provided





always that if in the event of an Emergency NATIS Representative considers it necessary to give an instruction orally, the Contractor shall immediately comply with such instruction and shall confirm in writing such oral instruction as soon as is possible under the circumstances.

- 1.8.2 The Contractor shall give adequate notice to NATIS of other instructions that may be required for the design and Execution of the Works in accordance with the Contract.
- 1.8.3 Where the Contractor fails to comply with an instruction, NATIS may engage others to give effect to the instruction. All costs and charges incurred by NATIS in engaging others shall be paid by the Contractor to NATIS or may, without prejudice to any other method of recovery, be deducted by NATIS from any monies due to the Contractor or may be recovered as a debt due and payable to NATIS on demand.

## 1.9 Guarantees

- 1.9.1 The Contractor shall, within [15 (Fifteen)] days of the date of acceptance of the Letter of Acceptance, provide to NATIS the Performance Guarantee from a scheduled bank in India with a branch at New Delhi, in a sum equal to the amount and the period of validity specified in Special Conditions of Contract and in the form appearing in Section 6.3 [Form of PB Guarantees] for the due observance and performance by the Contractor of the Contract. [The Contractor shall maintain the said Performance Guarantee at its own expense, so that it shall remain in full force and effect until the date set out in Special Conditions of Contract or until the issuance of the Defect Rectification Certificate, whichever is later.] In the event of a net increase in the Contract Sum due to the valuation of Changes equalling 10% or more of the Contract Sum, the total value of the Performance Guarantee shall be increased proportionately by the Contractor, if required by NATIS. The cost of obtaining (and increasing) the Performance Guarantee shall be at the expense of the Contractor and shall be included in the Contract Sum.
- 1.9.2 If the Performance Guarantee is or becomes invalid or unenforceable for any reason whatsoever, or if such security is withdrawn or expires, the Contractor must immediately notify NATIS Representative and obtain within [7 (seven)] days a replacement Performance Guarantee in the form appearing in Section 6.3 [Form of PB Guarantees] and which is acceptable to NATIS in its absolute discretion.
- 1.9.3 The provision, maintenance and renewal by the Contractor of the Performance Guarantee in accordance with this **Clause 1.9** [Guarantees] shall be a condition precedent to any payment by NATIS to the Contractor under the Contract.
- 1.9.4 If the Contractor shall fail to provide, maintain and renew the Performance Guarantee in accordance with the Contract, then NATIS may, without prejudice to any other rights and remedies to which it may be entitled, by written notice immediately terminate the Contractor's employment in accordance with **Clause 34.1** [Termination].





- 1.9.5 (i) In addition to any other rights contained in the Contract, NATIS shall be entitled to retain from each payment of the Contract Price an amount (the Retention Amount) equal to the percentage of the Gross Certifiable Amount, specified in the Special Conditions of Contract.
- (ii) NATIS shall certify to the Contractor, in case not explicitly mentioned in the Special conditions of Contract.
- (a) 50% of the total Retention Amount held, in the Certificates of Payment to be issued by NATIS following Completion of the Works; and
- (b) The balance of such Retention Amount (50%) as part of the Final Payment or, if a Dispute arises under the Contract, after the final determination of the Dispute, whichever occurs later. NATIS may, in its absolute discretion, on completion by the Contractor to the satisfaction of the NATIS Representative of any Punch List Items set out in the Completion Certificate, pay to the Contractor a proportion of that retention held, provided always that the Contractor shall not be able to dispute or in any way challenge NATIS determination of such proportion.
- 1.9.6 The NATIS shall return the Performance Guarantee to the Contractor within 30 days (a month) after receiving the "Defect Rectification Certificate", from the NATIS representative.

## 1.10 Detailing

- 1.10.1 NATIS Representative shall be entitled (but, save when expressly provided to the contrary in the Contract, no obligation) to supply to the Contractor from time to time, during the progress of the design and the Works, such further drawings, specifications and instructions as the NATIS Representative shall consider necessary for the purpose of the proper and adequate design and Execution of the Works. The Contractor shall carry out and be bound by the same but shall not be entitled to any extension of time or further payment in relation thereto except as provided by **Clause 19** [Extension of Time for Completion] and **Clause 23** [Change].

## 2. THE NATIS REPRESENTATIVE

### 2.1 The NATIS Representative's duties and authorities

- 2.1.1 The NATIS Representative shall be appointed by and shall be responsible to NATIS and shall carry out the duties specified in, or necessarily implied from the Contract and shall exercise the authority delegated to it by NATIS. The NATIS representative shall also be the Engineer In-charge for the contract, unless specified by NATIS. Subject to the provisions of this **Clause 2** [The NATIS Representative] and to any provision of the Contract, which





provides to the contrary, the Contractor shall take instructions, notices, communications, decisions and approvals only from NATIS Representative.

2.1.2 The NATIS Representative's duties would include to watch and supervise the Works and to test and examine any Goods to be used or workmanship employed in connection with the Works. The NATIS Representative shall have no authority to amend the Contract, to release the Contractor of any of his duties, liabilities or obligations under the Contract, nor, create estoppel against it or NATIS in respect thereof, nor except as expressly provided hereunder or elsewhere in the Contract, to order any Work involving delay or any extra payment by NATIS, nor to make any variation of or in the Works nor to waive any right of NATIS under the Contract. He shall have No authority to relieve the Contractor of any of his obligations under the Contract.

2.1.3 The following shall be the authority of the NATIS Representative, but not limited to, with prior approval of NATIS.

- (1) Issuing the Notice to Proceed or the order to commence any part of the works.
- (2) Approval of Sub-Contractor for any part of the Works.
- (3) Issuing the payment certificate and certifying additional cost under the provisions of contract.
- (4) Awarding an extension of time.
- (5) Issuing notices to contractor with regard to day to day works.
- (6) Negotiating the rates on item rates under variation.
- (7) Issuing a Defects Liability Certificate.
- (8) Levy of Liquidated damages.
- (9) Executing the variation of quantities.
- (10) Issuing Change Notices and Change orders.





## **2.2 NATIS Representative's authority to delegate**

- 2.2.1 NATIS Representative may from time to time delegate any of its functions to assistants and may at any time revoke any such delegation. It shall notify the Contractor of the names, duties and scope of authority of such assistants. NATIS Representative may not delegate any duty or authority, and such assistants shall have no authority, to initiate any Change or to issue any certificates, notices, instructions or decisions which may lead to any increase in the Contract Sum or any extension of time. Any such Change Order, Change Notice, certificate, notice, instruction or decision issued by an assistant of the NATIS Representative shall immediately be referred to the NATIS Representative for confirmation before the Contractor takes any action with regard thereto.
- 2.2.2 Any written communication between the Contractor and any assistant of NATIS Representative shall immediately and contemporaneously be copied by the Contractor to NATIS Representative.
- 2.2.3 Any examination, testing or similar act by any assistant of NATIS Representative, in accordance with its delegation, shall have effect as though it had been an act of NATIS Representative.
- 2.2.4 However, if the Contractor questions any communication of an assistant of NATIS Representative, the Contractor shall, not later than [7 (seven)] days after receipt of such communication, refer the matter to NATIS Representative, who shall confirm, reverse or vary such communication.

## **2.3 Duration of powers and authorities**

The powers and authorities vested in the NATIS Representative and the functions of any assistant of NATIS Representative under the Contract shall continue and be in force until the duties of NATIS Representative set out in the Contract have been fully discharged or, in the case of any assistant of NATIS Representative, until NATIS Representative revokes or removes the assistant's powers and authorities or until the period specified in the delegation to it expires.

## **2.4 NATIS protection**

The Parties acknowledge and agree that provisions in the Contract to the effect that matters or work to be done under the Contract shall be carried out with the consent, non-objection or to the satisfaction of or be certified, determined, accepted, confirmed or inspected by the NATIS Representative are inserted as protection to NATIS and it is the sole responsibility of the Contractor to ensure that the Works are designed and executed in all respects in accordance with the Contractor's obligations under the Contract. The Contractor further acknowledges and agrees that such provisions are additional to any other rights, whether under the Contract or otherwise, which NATIS may have for breach of any obligation under the Contract by the Contractor and that no payment by NATIS nor any expression or





implication of satisfaction or acceptance nor any action, examination, comment, rejection, confirmation, certification, determination, consent, non-objection, approval or notice by the NATIS Representative or failure to do the same shall restrict, debar, exclude or waive any claims, rights or actions whatsoever by NATIS for any breach of any such obligation by the Contractor.

### 3. COMMENCEMENT AND THE NOTICE TO PROCEED

#### 3.1 Condition Precedent

The Contract shall become legally binding and in force only upon:

- 3.1.1 the submission of the Performance Guarantee in accordance with **Clause 1.9** [Guarantees];
- 3.1.2 satisfaction of any other condition(s) precedent stated in the Special Conditions of Contract;

save for the provisions of this **Clause 3.1** [Conditions Precedent], **Clause 1.1** [Definitions and Interpretation], **Clause 1.7** [Confidentiality], **Clause 6.1.3(vi)** [The Contractor's general responsibilities], **Clause 6.3** [Contractor's Documents], **Clause 31** [Dispute Resolution Procedure] and **Clause 34.3** [Governing Law and Jurisdiction] which shall be effective, legally binding and in force immediately upon the Effective Date.

#### 3.2 The Notice to Proceed

- 3.2.1 After satisfaction of the conditions precedent set out in **Clause 3.1** [Conditions Precedent], the Contractor shall obtain a Notice to Proceed from NATIS prior to commencing the design and Execution of the Works.
- 3.2.2 NATIS shall give the Contractor not less than [7 (seven)]days notice of the date of issue of the Notice to Proceed or such other shorter period as may be mutually agreed between the Parties.
- 3.2.3 Upon receipt of the Notice to Proceed, the Contractor shall proceed immediately to design and Execute the Works.

#### 3.3 Following the Notice to Proceed





3.3.1 Within [30 (Thirty)] days or such other period as may be specified by the NATIS Representative, of the Notice to Proceed, the Contractor shall submit to NATIS Representative:

(i) in accordance with **Clause 6.3 [Contractor's Documents]**:

- (a) the Quality Assurance Plan;
- (b) the Contractor's Health, Safety, Security and Environment Plan;
- (c) the Initial Programme and
- (d) the Contractor's Project Site Safety Plan
- (e) the subcontract management plan

(ii) the following:

- (a) evidence of full compliance of its insurance obligations in accordance with **Clause 25.4 [Evidence]**;
- (b) evidence that the Contractor has made adequate arrangement for mobilisation at the Project Site.

3.3.2 It shall be a condition precedent to any payment under the Contract that the Contractor is able, pursuant to **Clause 6.3 [Contractor's Documents]** to proceed on the basis of the documents submitted pursuant to **Clause 3.3.1 [Following the Notice to Proceed]**.

## 4. THE PROJECT SITE

### 4.1 Access to and possession of the Project Site

4.1.1 Save insofar as the Contract may prescribe:

- (i) the extent of portions of the Project Site of which the Contractor is to be given access from time to time; and





- (ii) order in which portions shall be made available to the Contractor;

NATIS will, simultaneously with the Notice to Proceed, give to the Contractor access to and possession of so much of the Project Site as may be reasonably required by the Contractor to commence and proceed with the design (to the extent required under the Contract) and Execution of the Works and to carry out its obligations in accordance with the provisions of the Contract. NATIS will, from time to time as the design (to the extent required under the Contract) and Execution of the Works proceeds, give to the Contractor access to and possession of such further portions of the Project Site as may be reasonably required to enable the Contractor to proceed with the design (to the extent required under the Contract) and Execution of the Works in accordance with the Contract.

4.1.2 The Contractor shall not be entitled to uninterrupted access to or exclusive possession of any part of the Project Site and without prejudice to any other restriction contained in the Contract, the Contractor's rights of access to and possession of any part of the Project Site shall in addition be subject to:

- (i) any rights of public passage or access existing over any part of the Project Site from time to time;
- (ii) the right of NATIS, the NATIS Representative, the Related Works Contractors, and representatives of any statutory authority, to have access to:

and

- (a) view the Works or any operations at the Project Site on reasonable notice;
- (b) visit any site or workshop where Goods and Materials are being manufactured, prepared or stored, on reasonable notice and during normal working hours, for the purposes of general inspection and of attending any test or investigation being carried out in respect of the same; and
- (c) visit and use, and their staff and visitors may visit and use, any facilities provided on the Project Site for their use; and
- (d) the Project Site at any time in an Emergency as any of them (acting reasonably) considers necessary in the circumstances;

provided always that such persons shall comply with all relevant safety procedures.





4.1.3 The Contractor shall liaise with each of the Related Works Contractor(s) in relation to when the various portions of the Project Site will be made available to the Contractor. The Contractor shall keep the NATIS Representative fully informed as to all communications with such Related Works Contractors as aforesaid. If the Contractor is likely to be delayed by reason of possession not being made available, it shall give notice in writing to the NATIS Representative immediately.

4.2 **Unauthorised persons**

The Contractor shall be fully responsible for the presence on or around or for the entry to the Project Site or for any other act, omission, default or interference affecting the Project Site or the Execution of the Works, by or caused by any person not authorised to be on the Project Site and any such act, omission, default or interference shall not be a breach of the obligations of NATIS to provide access to the Project Site.

4.3 **Rights of possession**

4.3.1 The Contractor shall not part with or create any Encumbrance on the whole or any part of the Project Site.

4.3.2 The Contractor shall not without the prior written consent of NATIS use the Project Site for any purpose other than for the purpose of the design (to the extent required under the Contract) and Execution of the Works.

4.4 **Additional access and facilities**

The Contractor shall bear all costs and charges for any access required by it additional to those provided by NATIS. The Contractor shall provide at its cost any additional facilities outside the Project Site as may be required by it for the purposes of the Works and the performance of its obligations under the Contract, provided that the Contractor shall obtain the prior written consent of the NATIS Representative. The Contractor shall allow access to and use of the Project Site/ Project Facility for laying/installing telegraph lines, electric lines or for such other public purposes as NATIS or any Statutory Authority may specify.

**5. CONDITION OF THE PROJECT SITE**

**5.1 Information from NATIS**

The Contractor acknowledges and agrees that any information and data on climatic, hydrological, topographical and general conditions relating to the Project Site made available to it by NATIS has been done so for the convenience of the Contractor and that the





Contractor enters into the Contract based upon its own investigations and determinations. Without prejudice to **Clause 1.5** [Background Information and the manner in which discrepancies are resolved], NATIS shall have no responsibility to the Contractor (whether in contract, tort, for breach of statutory duty or howsoever other arising) for or in relation to such information and data whether as to its accuracy, adequacy, sufficiency or completeness.

## 5.2 Contractor to inspect

Without prejudice to **Clause 5.1** [Information from NATIS] and without limitation to any other provision of the Contract, the Contractor shall be deemed prior to executing the Contract, to have and warrants that it has inspected to the full extent necessary and examined to its satisfaction the Project Site and its surroundings and where applicable, any existing structures or works on, over and under the Project Site and is familiar with and has satisfied itself with the Project Site Conditions including, without limitation:

- 5.2.1 the nature of the climatic, hydrological, topographical, ecological, environmental conditions at the Project Site (including without limitation all hazards and the potential for any contamination of the Project Site or the sub-soil by any noxious or hazardous substances) and the sub-soil and the general conditions of the Project Site;
- 5.2.2 the form and nature of the Project Site (including existing ground levels) and its adequacy for the purposes of the design and Execution of the Works;
- 5.2.3 the risk of injury or damage to property adjacent to the Project Site and to occupiers and users of such property;
- 5.2.4 the extent and nature of the design, work, plant and materials necessary for the design and Execution of the Works;
- 5.2.5 the means of communication with and access (including vehicular access) to and from the Project Site, the accommodation it may require and the adequacy of the rights of access set out in the Contract for those purposes (including the nature and extent of any restrictions upon access or use of the Project Site);
- 5.2.6 the possibility of interference by persons with access to or use of or possession of the Project Site;
- 5.2.7 the precautions and the times and methods of working necessary to prevent any nuisance, whether public or private, being caused to any third parties on or around the Project Site;
- 5.2.8 the whereabouts of existing services and mains on or around the Project Site;





- 5.2.9 conditions affecting shipping and transportation of Goods, plant, equipment and Materials to, through and from the Project Site;
- 5.2.10 the availability and quality of labour required for the Works;
- 5.2.11 the availability of water and electrical power for the Works;
- 5.2.12 the Applicable Laws and Applicable Clearances and local customs relating to the Project Site and the Works; and
- 5.2.13 the adequacy and suitability of any design or works carried out by other contractors on or around the Project Site which design or works the Contractor has taken over or will take over with the Project Site or with which the design and/or the Execution of the Works is required to integrate.

### 5.3 Claims

No claim by the Contractor for additional payment or compensation or any extension of time on the ground of any misunderstanding or misapprehension in respect of the matters referred to in this **Clause 5** [Condition of the Project Site] or on the ground that incorrect or insufficient information was given to it by NATIS, NATIS Representative or NATIS advisors or consultants, any Statutory Authority, nor shall the Contractor be relieved from any liability, risk or obligation imposed on or undertaken by it under or in relation to the Contract on any such ground or on the ground that it did not or could not foresee any matter which may in fact affect or have affected the design and Execution of the Works.

### 5.4 Fossils and antiquities

5.4.1 The Contractor acknowledges that as between NATIS and the Contractor all fossils, antiquities, and other objects having artistic, religious, historic or monetary value and human remains which may be found on or at the Project Site ("fossils and antiquities") are or shall be deemed to become the absolute property of NATIS.

5.4.2 Upon the discovery of any fossils and antiquities during the course of the Works, the Contractor shall, at its own cost:

- (i) immediately give notice to NATIS and the NATIS Representative of such discovery;





- (ii) take all steps not to disturb the item and, if necessary, cease any Works in so far as the carrying out of such Works would endanger the item or prevent or impede its excavation; and
- (iii) take all steps reasonably necessary to preserve the item in the same position and condition in which it was found and take all reasonably necessary precautions to prevent its personnel or other persons from removing or damaging any of these items.

5.4.3 Following receipt of a notice from the Contractor, NATIS, through the NATIS Representative shall as soon as reasonably practicable issue an instruction to the Contractor specifying what action NATIS requires the Contractor to take in relation to the discovery of the fossil or antiquity.

5.4.4 If instructed by the NATIS Representative, the Contractor shall allow representatives of NATIS and/or any Statutory Authority to enter the Project Site for the purposes of removal or disposal of such fossil or antiquity, provided that such entry shall be subject to complying with all relevant safety procedures.

5.4.5 The Contractor shall, at its own cost and without a right to any extension of time, promptly and diligently comply with any instruction issued by the NATIS Representative under this Clause 5.4 [Fossils and antiquities].

## 5.5 Property in excavated material

All materials obtained from excavations or found on or under the Project Site or under any additional site which the Contractor may be allowed to occupy, shall remain the property of NATIS and shall not be used in the Works or sold or otherwise disposed of without the prior written consent of NATIS unless otherwise expressly provided for in the Technical Conditions of the Contract. No excavations are to be made upon the Project Site beyond those shown on the Contractor's Documents or described in the Technical Conditions of the Contract without the prior written consent of the NATIS Representative.

## 6. THE CONTRACTOR

### 6.1 The Contractor's general responsibilities

6.1.1 Subject to and in accordance with the terms and conditions of the Contract, the Contractor shall to the satisfaction of NATIS and NATIS Representative, design and Execute the Works and carry out its other obligations under and/or in relation to the Contract and provide all personnel and labour, including the supervision thereof, materials, offices,





workshops, tools, machinery, equipment and all other resources and things, whether of a temporary or permanent nature, required in or for such design and Execution of the Works and for carrying out such obligations.

6.1.2 The Contractor shall assume full responsibility for the design and Execution of the Works in accordance with the Contract so as to meet the Time for Completion.

6.1.3 The Contractor shall at its own expense:

- (i) take full responsibility for the adequacy, stability and safety of the Works and of all on-site and off-site operations and construction, transportation, testing and reliability and acceptance procedures;
- (ii) organise the Project Site during the Execution Period with regard to safety precautions, fire protection, security, transportation, delivery of Goods, Materials, plant and equipment, control of pollution and the maintenance of competent personnel and labour and general site services;
- (iii) do everything necessary (including the payment of all relevant fees) to acquire and maintain all Applicable Clearances and which are not specified as responsibility of NATIS in Special Conditions of Contract. If requested by NATIS, the Contractor shall assist NATIS in obtaining in a timely and expeditious manner any Applicable Clearance which NATIS is required under the Contract to maintain;
- (iv) take all reasonable steps, consistent with a good and experienced employer to maintain harmony and good industrial relations among the personnel employed in connection with the performance of its obligations under the Contract;
- (v) provide to NATIS, NATIS Representative and representatives of any Relevant Authority and Statutory Authority such assistance as they may reasonably require to carry out their respective duties and functions;
- (vi) at all times ensure that it has sufficient, suitable and qualified personnel at the Project Site and in sufficient number to undertake the responsibilities imposed upon the Contractor under the Contract and to provide full attention to the design and Execution of the Works.

## 6.2 The Contractor's representations and warranties

In addition to any other **Clause** contained in the Contract, the Parties agree that the principal objective of the Contract is the timely completion of the Project Facility of which the Works form an integral part. The Contractor warrants that it is fully experienced in the planning, programming, design, procurement and supply, testing, and execution and co-ordination of





construction activities of facilities, complexity and size of the Works and that it possesses the level of skill and expertise commensurate with such experience, upon which skill and expertise NATIS is entirely reliant and the Contractor hereby represents and warrants to NATIS that:

### Design

- 6.2.1 it has satisfied itself as to, and adopts and accepts full responsibility for any design of the Works contained in and reflected by Technical Specifications and Drawings;
- 6.2.2 there has been exercised and will continue to be exercised in the design and specifications for the Works all the skill, care and diligence to be expected of professionals experienced in and possessing all the expertise necessary for the design and specification of similar projects of the size, scope and complexity of the Works;
- 6.2.3 the Works have been and will continue to be designed (to the extent required under the Contract) and specified utilising state of the art systems, procedures and technology, high quality goods, Materials and the high standards of workmanship and fabrication consistent and in compliance with Technical Specifications and Drawings;
- 6.2.4 the Contractor further warrants that upon the Date of Completion of the Works, the Works will be in a condition which will enable NATIS to meet those Performance Standards which relate to the Works;
- 6.2.5 that it recognises that the process of producing, optimising, developing and finalising the design of the Works will require the closest consultation, co-operation and co-ordination between itself, NATIS, the NATIS Representative, any Relevant Authority and the Related Works Contractors and that it has taken account of the same in the Programme and the Contract Sum. The Contractor further recognises that it will be necessary for the Parties to further develop and agree to such methods and procedures to enable the same to be carried out;
- 6.2.6 that it is fully responsible for the integration of and for the full and complete co-ordination of the design (to the extent required under the Contract) of the Works with the Related Works and that:
- (i) the Contract Sum is inclusive of the cost of the Contractor's compliance under this **Clause 6.2** [The Contractor's Representations and Warranties] and **Clause 13** [Related Works]; and
  - (ii) the Contractor has programmed and will continue to programme the design and Execution of the Works in such a way as to ensure its compliance with its obligations in respect of Related Works as set out in **Clause 13** [Related Works].





## Workmanship

- 6.2.7 the Works will be Executed and defects, remedied in accordance with Good Industry Practice, using state of the art systems and technology and accepted professional standards, codes of practice and regulations, and shall meet the intents and objectives of the Contract and comply with all Applicable Laws and be in accordance with Technical Specifications and Drawings and the functional and other requirements of the Contract, whether expressed or reasonably to be inferred therefrom;
- 6.2.8 the personnel to be employed by the Contractor in or about the Execution of the Works will be properly skilled, competent and experienced having regard to the nature and extent of the Works;
- 6.2.9 the Works and every part thereof will be complete in all parts, will be free from defects in design, materials and workmanship and will be in conformity with Technical Specifications and Drawings;

## 6.3 Contractor's Documents

6.3.1 The Contractor shall prepare all Contractor's Documents. The Contractor shall submit to NATIS Representative:

- (i) within the time given in the Contract, or if no time is so specified then in accordance with the Programme or as may be directed by NATIS Representative, those Contractor's Documents called for in the Contract or as NATIS Representative may require and in the numbers and format required by the Contract or, if no such number and format is stated in the Contract, as required by NATIS Representative; and
- (ii) during the progress of the Works such additional Contractor's Documents within such times and in such numbers and format as NATIS Representative may reasonably require.

6.3.2 NATIS Representative shall approve and comment on any Contractor's Documents submitted in accordance with **Clause 6.3.1** [Contractor's Documents] within [15 (fifteen)] Business Days after receipt of the Contractor's Document (the "Review Period"). NATIS Representative shall signify "No Comments" or "comments made" or "resubmit" and return one copy of the Contractor's Document to the Contractor. If NATIS Representative fails to do so within the Review Period, it shall be deemed that NATIS Representative has signified "No comments" and the Contractor may proceed as it deems appropriate to comply with its obligations under the Contract.





- 6.3.3 The notes "No comments" or "comments made" will enable the Contractor to proceed on the basis of the Contractor's Documents provided that in the latter case the Contractor sufficiently addresses any comments made by NATIS Representative.
- 6.3.4 Where any Contractor's Document is marked "resubmit" the same shall be amended, modified or prepared again, as the case may be, and resubmitted by the Contractor and the procedure set out in this Clause 6.3 [Contractor's Documents] shall apply to the re-submitted Contractor's Document.
- 6.3.5 No design or Execution of any part of the Works shall commence prior to the expiry of the Review Period for those Contractor's Documents which are relevant to its design and Execution except as may be expressly agreed in writing by NATIS Representative.
- 6.3.6 Notwithstanding any of the provisions of the Contract relating to Contractor's Documents, the Contractor shall be fully responsible for:
- (i) the adequacy of the Contractor's Documents in accordance with the Contract; and
  - (ii) any failures of any Contractor's Documents whether to comply with the Contract and/or to meet its obligations thereunder or otherwise and for any ambiguities, failures, discrepancies, insufficiencies, lack of fitness for purpose, errors, omissions, design or construction impracticalities in any such Contractor's Documents howsoever such ambiguities, failures, discrepancies, insufficiencies, lack of fitness for purpose, errors, omissions, design or construction impracticalities may have arisen.
- 6.3.7 The Contractor shall at its own expense carry out any alterations or remedial work necessitated by reason of any ambiguities, failures, discrepancies, insufficiencies, lack of fitness for purpose, errors, omissions, design or construction impracticalities in any Contractor's Documents and shall modify the Contractor's Documents accordingly, or if the same be done by or on behalf of NATIS, NATIS shall be entitled to recover from the Contractor all costs reasonably incurred therein and may, without prejudice to any method of recovery, deduct the same from any monies due or which may become due to the Contractor.
- 6.3.8 The NATIS Representative shall not be obliged to comment upon any Contractor's Documents without first satisfying itself that to the extent required, such comment is issued with the consent, non-objection or approval of a Statutory Authority, if so required.
- 6.3.9 If the Contractor wishes to modify any Contractor's Document (including any design contained in Contractor's Documents) which has previously been reviewed by the NATIS Representative, the Contractor shall immediately give notice to the NATIS Representative.





Thereafter, the Contractor shall submit revised documents to the NATIS Representative in accordance with **Clause 6.3** [Contractor's Documents].

- 6.3.10 Save as expressly provided in this Contract, the Contractor shall not seek to recover from NATIS any loss or claim which may arise from the adoption, use or application by or on behalf of the Contractor or any other person for whom the Contractor is responsible, of the design in any Contractor's Documents.
- 6.3.11 No review, comment, suggestion, approval on any other communication by the NATIS Representative made in accordance with the review procedure specified in this **Clause 6.3** [Contractor's Documents] or in any other system, method or procedure subsequently agreed, shall in any way relieve the Contractor of any of its obligations under the Contract.
- 6.3.12 In the case of any Contractor's Documents relating to the design of the Works, such Contractor's Documents shall become part of the Final Design of the Works in accordance with the following:
- (i) when the Contractor submits the final submission for either the structural and layout design or the finishes and aesthetics design of a specified area in the Project Site, it shall notify the NATIS Representative by issue of a notice titled "Notice of Final Design of a Specified Area" accompanying such Contractor's Document. Such notice shall identify the relevant specified area in the Project Site, the date of submissions of all the Contractor's Documents relating to either the structural and layout design or the finishes and aesthetics design of such specified area in the Project Site and confirm that no further structural and layout design or finishes and aesthetics design is to be undertaken in respect of such specified area. Any Contractor's Document which has been accompanied by a Notice of Final Design of a Specified Area in the Project Site and which has reached a stage at which the NATIS Representative can confirm and signify in writing "no comment" or "comments made" in accordance with **Clause 6.3.2** [Contractor's Documents] will enable the Contractor to proceed on the basis of each Contractor's Document in respect the of the structural and layout design or finishes and aesthetics design (provided that in the latter case the Contractor fully addresses any comments made by the NATIS Representative) and at which point such Contractor's Documents will become part of the Final Design of the Works.
  - (ii) In the case of Contractor's Documents relating to the design of the Works, other than the structural and layout design or the finishes and aesthetics design of a specified area in the Project Site, and otherwise as may be directed by the NATIS Representative, such Contractor's Documents shall become part of the Final Design of the Works when the NATIS Representative can confirm and signify in writing "no comment" or "comments made" in accordance with **Clause 6.3.2** [Contractor's Documents] provided that in the latter case the Contractor fully addresses any comments made by the NATIS Representative.





#### 6.4 Design Development

Notwithstanding any of the provisions of the Contract including those relating to the instructions or approval or review of or comment on any design documentation or any Contractor's Document by NATIS, the NATIS Representative, and/or any Relevant Authority:

- (i) the Contractor is responsible for initiating and progressing the production, optimisation, development and finalisation of the design of the Works and for ensuring a regular flow of design documentation to the NATIS Representative in a timely, orderly, logical and consistent manner and so as not to delay or disrupt the regular progress of the design development or the commencement of the Execution of any part of the Works on the Project Site or the regular progress of the Execution of the Works or any part thereof;
- (ii) it shall be a condition precedent to the Contractor's entitlement to be paid or reimbursed any amount in respect of work Executed or Materials or any part thereof supplied under the Contract that the same shall have been Executed or supplied in accordance with the Final Design of the Works;
- (iii) the Contractor shall at all times during the design and Execution of the Works keep itself informed and the NATIS Representative duly apprised, of any changes in Good Industry Practice, state of the art systems and technology, codes of practice and regulations and of any design developments or enhancements which occur or may become available during the course of the design (to the extent required under the Contract) or Execution of the Works and which relate to or could result in an improvement of the Project Facility. The NATIS Representative may instruct the implementation of any such change, development or enhancement and the Contractor shall immediately implement the same at its own cost and without the right to any additional payment or any extension of time;
- (iv) at any time until the design of any part of the Works has become part of the Final Design of the Works, the NATIS Representative may give an order in writing to the Contractor relating to the design of such part of the Works (known as a "Design Order"). If in the opinion of the Contractor, any Design Order is likely to prevent the Contractor from or in fulfilling any of its obligations under the Contract in respect of the design or Execution of the Works, either directly or indirectly, it shall notify the NATIS Representative thereof in writing as soon as practicable after receipt of the Design Order from the NATIS Representative, giving a full statement of its reasons, and the NATIS Representative shall decide forthwith whether or not the same shall be carried out. The NATIS Representative may confirm the Design Order in writing and may modify the said obligation to such an extent as it considers may be justified. Until the NATIS Representative so confirms the Design Order, it shall be deemed not to have been given; and





- (v) if such Design Order shall involve any work or supply which is contrary to the Technical Specifications and Drawings and could not be inferred from the Technical Specifications and Drawings then such Design Order shall be treated as an instruction of the NATIS Representative under **Clause 23.2.1(i)** [Procedure for Changes], otherwise such Design Order shall be actioned by the Contractor at its own cost with no entitlement to any extension of time in respect thereof. Provided always that the onus of proving that such work or supply is contrary to and could not be inferred from the Technical Conditions of the Contract shall be on the Contractor.

## 6.5 Contractor's Guarantee

- 6.5.1 The Contractor shall guarantee each of the Systems for the respective periods and commencing from the dates ascribed to each thereto under the Special Conditions of Contract ("Guarantee Period"), to the intent that if during the period any defect, inadequacy or unsuitability of design, manufacture, workmanship or materials or failure to meet in any or all respects the requirements of the Contract shall arise or become apparent in any part of the Works so guaranteed, written notice of such defect, inadequacy or unsuitability, or failure to meet the requirements of the Contract shall be given by the NATIS Representative to the Contractor who shall forthwith submit to the NATIS Representative for its consent, its written proposals for the remedying or replacement of the same at no cost to NATIS. Upon receipt of the written consent of the NATIS Representative to the Contractor's proposals or any amendments thereto the Contractor shall forthwith, at a time or times convenient to NATIS and the NATIS Representative, implement its proposals as accepted with all due speed. If the Contractor shall fail to submit its written proposals within a time considered reasonable by the NATIS Representative or if such proposals are not, in the NATIS Representative's opinion, satisfactory, NATIS may employ and pay other persons to carry out the necessary remedial work or carry out such work itself and the Contractor shall be liable for all costs in connection with such remedial work, which NATIS may recover from the Contractor as debt.
- 6.5.2 The Contractor shall at all times save harmless and indemnify NATIS from and against all claims, liabilities, expenses, costs and losses suffered or incurred by NATIS which may arise out of or in connection with any defect, inadequacy or unsuitability of the design, manufacture, workmanship or materials or failure to meet in any or all respects the requirements of the Contract or the remedying thereof either by the Contractor, NATIS, or by others employed by NATIS.
- 6.5.3 NATIS rights under **Clause 6.5** [Contractor's Guarantee] are without prejudice to any other right which it may have whether at law or otherwise.





## 7. SUBCONTRACTORS

### 7.1 Subcontracting

The Contractor shall not subcontract any part of the Works without the prior consent of NATIS or the NATIS Representative. Any such consent shall not relieve the Contractor from any liability or obligation under the Contract and the Contractor shall be responsible for the acts, defaults and neglects of any Sub-Contractor, his agents, servants or workmen as fully as they were the acts, defaults or neglects of the Contractor, his agents, servants or workmen.

Provided that the Contractor shall not be required to obtain such consent for:

- (i) the provision of labour, or
- (ii) the purchase of materials which are in accordance with the standards and specifications specified in the Technical Specifications and Drawings, or
- (iii) the subcontracting of any part of the Works for which the Sub-Contractor is named in the Contract.

The Contractor shall, in order to obtain the prior written consent of NATIS, notify NATIS in writing of all subcontracts to be awarded under this Contract. Such notification shall not relieve the Contractor from any liability or obligation under the Contract. Subcontracts must comply with all the provisions of these Conditions of Contract. The Contractor shall promptly advise NATIS of the name of each Subcontractor which the Contractor intends to select to subcontract any part of the Works, and shall furnish to NATIS for approval such information concerning such subcontract as is necessary to determine its compliance with the Technical Specifications and Drawings and other requirements of this Contract, including (i) a description of such item of Materials or services being subcontracted, (ii) a technical analysis of each subcontractor's submission including the technical specifications of the equipment, materials or services being subcontracted, (iii) the purchase order (excluding price).

The Contractor may subcontract any part of the Works but not subcontract the whole of the Works under any circumstances. All Subcontractors shall be appropriately licensed to perform the subcontracted work.

### 7.2 Subcontractor's Warranty and Assignment of Sub-Contractor's' Obligations

As a condition to its consent to any Subcontractor, NATIS requires that the Contractor shall procure that any such subcontractor shall execute a warranty in favour of NATIS in the form





to be provided by NATIS under Schedule E to the Special Conditions of Contract at the same time as it executes a subcontract with the Contractor. The Contractor shall use all its best endeavours to procure the execution of the warranty.

In respect of the work Executed, or Materials supplied by a Subcontractor, any continuing obligation of a Subcontractor under the Subcontract extending for a period exceeding that of the Defects Rectification Period, shall be disclosed to NATIS by the Contractor and be assignable to NATIS or its nominee. The Contractor shall ensure that the Subcontractor shall any time, assign to NATIS, at NATIS's request, such continuing obligation of a Subcontract exceeding the Defects Rectification Period and the benefit of such obligation for the un-expired duration thereof.

### **7.3 Responsibility**

- 7.3.1 Subcontracting does not relieve the Contractor from any of its liabilities or obligations under the Contract.
- 7.3.2 The Contractor shall be fully responsible for the acts, defaults, omissions and neglects of any Subcontractor and their agents, employees, servants and workmen, as fully as if they were the acts, defaults, omissions and neglects of the Contractor.
- 7.3.3 No consent to the appointment of any Subcontractor or to the terms of any Subcontract by NATIS or NATIS Representative shall imply in any way that a Subcontractor has been nominated by NATIS, nor will it diminish in any way the Contractor's responsibility and liability for the acts, defaults, omissions and neglects of that Subcontractor
- 7.3.4 Without prejudice to the foregoing, the Contractor shall, on written notice from NATIS Representative, terminate the employment of any Subcontractor whose acts or omissions, in the reasonable opinion of NATIS Representative, are putting or shall put, the Contractor in breach of its obligations under the Contract and/or are causing or shall cause a Material Adverse Effect upon the design (to the extent required under the Contract) and Execution of the Works.
- 7.3.5 Nothing contained in the Contract shall render NATIS in any way liable to any Subcontractor and the Contractor shall indemnify and keep indemnified NATIS against all and any liabilities to, and costs, claims and demands of whatsoever nature by any Subcontractor.

### **7.4 Subcontract Terms**

The Contractor shall procure that:





7.4.1 every Subcontractor has knowledge of those terms of the Contract (other than the Contractor's prices and rates) which are relevant to the Subcontractor and provisions in the Contract relating to confidentiality and each Subcontract entered into by the Contractor shall be let on such terms and conditions as are reasonably necessary for the Contractor to ensure compliance with its obligations under the Contract insofar as they relate to the subject matter of the Subcontract;

7.4.2 included in each Subcontract are, inter alia, terms expressly providing:

- (i) for deemed knowledge of the terms of the Contract and of the Technical Conditions of the Contract
- (ii) that the Subcontractor shall observe, perform and comply with the terms and conditions of the Contract (whether or not the Contract expressly requires the Contractor to obtain the Subcontractor's compliance therewith) insofar as they relate to the Subcontractor or that part of the Works (including, without limiting the generality of the foregoing, any design, inspection, testing, insurance, quality and assurance control, safety requirements or environmental regulations thereof or relating thereto) and shall not commit any action or fail to perform any action within the scope of its Subcontract which puts or shall put the Contractor in breach of its obligations under the Contract or which causes or shall cause a Material Adverse Effect upon the design (to the extent required under the Contract) and Execution of the Works;
- (iii) that the Subcontractor provides like warranties as given by the Contractor to NATIS;
- (iv) that the Subcontractor provides like indemnities as given by the Contractor to NATIS;
- (v) that to the extent the Subcontractor is to carry out any design, requiring the Subcontractor to maintain professional indemnity insurance upon customary and usual terms and conditions prevailing for the time in the insurance market and with reputable insurers and with a limit of indemnity which is commensurate with the design which the Subcontractor is to undertake for any one occurrence or series of occurrences arising out of any one event in respect of any negligence, omission or default in the design of the Subcontract;
- (vi) that where the Subcontract includes the undertaking of fabrication work and work of a similar nature, the Subcontractor warrants that it has reviewed the drawings provided by the Contractor and that such drawings will be suitable for the fabrication work proposed;





- (vii) that the Contractor is able to fully comply with its obligations **Clause 7.3** [Responsibility];
- (viii) that NATIS and the NATIS Representative is able to enter upon and remain in or about the site upon which the Subcontractor is undertaking any subcontracted work;
- (ix) the Subcontractor is able to provide to NATIS rights to Intellectual Property relevant to the Subcontract; and
- (xi) that upon Termination or repudiation or abandonment of the Contract by the Contractor, if so directed by the NATIS Representative, the Subcontractor undertakes to provide to NATIS all designs, documents, materials and other things intended for incorporation in the Works.

## **7.5 Subcontract Management**

7.5.1 The Contractor shall prepare and update a subcontract management plan regularly throughout the duration of the Contract to reflect the latest position of the Contractor's intentions and actions with regard to the subcontracting of the Works.

7.5.2 The Contractor shall within [15 (fifteen)] days of the Notice to Proceed, submit to the NATIS Representative in accordance with **Clause 6.3** [Contractor's Documents] a subcontract management plan which shall contain the following:

- (i) a proposed procurement strategy comprising a list of the proposed Subcontract packages and the contractual arrangements for each Subcontract package;
- (ii) a proposed procurement programme indicating the dates for tender invitation, tender return and Subcontract award;
- (iii) a list of proposed provisions to ensure the requirements of the Contract are reflected in the Subcontracts;
- (iv) details of the lines of communication between the Contractor and the Subcontractors;
- (v) details of planned briefing sessions and meetings with each Subcontractor and regular meetings with the Subcontractors' senior off-site management to review performance and take corrective actions;





- (vi) a Subcontract interface schedule describing details at the interfaces between individual Subcontractors and between Subcontractors and the Contractor to ensure that there are no gaps with regard to the allocation of work and risk;
- (vii) a management plan for any key elements of resources to be provided by the Contractor to ensure an adequate and timely flow of resources to the Subcontractors;
- (viii) procedures for programme control, quality control, safety control and environmental control;
- (ix) a schedule of all Changes ordered by the NATIS Representative under the Contract showing the actions taken by the Contractor to ensure proper implementation of Changes through the relevant Subcontractors;
- (x) a plan providing a means for auditing Subcontractors' receipt of payments from the Contractor and payment of wages by the Subcontractors to their workmen; and
- (xi) the Contractor's approach to resolving problems and difficulties between the Contractor and individual Subcontractors and the Contractor's approach to resolving problems and difficulties between the individual Subcontractors.

Within [14 (fourteen)] days after entering into a Subcontract, the Contractor shall update and submit the subcontract management plan to the NATIS Representative.

#### **7.6 Cancellation of Subcontracts**

No subcontract shall bind or purport to bind NATIS and the Contractor shall ensure that each such subcontract shall contain provisions (a) permitting assignment thereof to NATIS upon NATIS's written request, and (b) the right of the Contractor to unilaterally cancel all or a portion of such subcontract which right will be exercised by Contractor if requested by NATIS.

### **8. SUFFICIENCY OF THE CONTRACT SUM**

The Contractor shall be deemed to have satisfied itself before entering into the Contract as to the correctness and sufficiency of the Contract Sum and of the rates and prices specified, and have based the Contract Sum on the data, interpretations, necessary information, inspections, examinations and satisfaction as to all relevant matters. The Contract Sum will not be adjusted save as expressly provided in the Contract, and includes any and all direct, indirect and ancillary charges and costs of whatsoever nature, all profit, all license, royalty and other





fees, and consumable materials to be provided hereunder and Taxes, duties, tariffs, fees, penalties, levies, insurance premiums, including all Contractor's equipment and licence fees and other charges relating to or arising out of the Contract and the Execution of the Works including its obligations in relation to the Related Works save as expressly provided for in the Contract and in each case, all deductions and withholdings therefor.

## 9. COMMENCEMENT OF THE WORKS

### 9.1 The Programme

9.1.1 The Contractor and NATIS hereby acknowledge and agree that the expeditious preparation and implementation of a programme is of paramount importance in ensuring the proper and effective monitoring and management of the progress of the Works and the co-ordination of the same with any Related Works. Accordingly, the Contractor agrees to co-operate fully with NATIS in adopting the procedure set out herein so as to ensure that the Programme is submitted as specified in the clauses below.

9.1.2 The Contractor shall submit an Initial Programme to NATIS Representative within [fifteen (15)] days of the Notice to Proceed. The Initial Programme shall show the order in which the Contractor proposes to carry out the Works in the first [90 (ninety)] days following the Notice to Proceed. The Initial Programme shall have regard to, and be consistent with the Time for Completion. The Initial Programme shall be maintained in a "rolling format" updated and submitted on a monthly basis. Every quarter, the Initial Programme shall show progress for the [60 (sixty)] days immediately prior to the data date and proposed works for the [90 (ninety) days] following the data date (the "data date" being the date on which progress is updated on the programme).

9.1.3 (i) The Contractor shall submit a further detailed programme within [15 (fifteen)] days of the Notice to Proceed in addition to the programme submitted in accordance with **Clause 9.1.1** [The Programme]. The said programme shall be submitted in accordance with **Clause 6.3** [Contractor's Documents] and shall incorporate the Initial Programme and shall be in a form acceptable to NATIS Representative. The said programme shall be compiled and shall show or include, but not be limited to, the following:

- (a) the Time for Completion of the Works;
- (b) the order in which the Contractor intends to design and Execute the Works;
- (c) define in detail all of the Contractor's work on the Project Site;
- (d) the periods for submission of any Contractor's Documents to NATIS Representative in accordance with **Clause 6.3** [Contractor's Documents]





together with the periods for comment to be given by NATIS or any third parties;

- (e) the Contractor's proposals for complying with its obligations under the Contract in relation to Related Works (including the incorporation within the Programme, of the requirements of any person whose co-operation is needed for the successful Completion of the Works);
  - (f) details of any Temporary Works which, in the Contractor's opinion, are critical to the satisfactory Completion of the Works.
  - (g) the critical path(s) which shall be printed in colour unless otherwise agreed with the NATIS Representative; and
  - (h) a unique identification/reference number and revision status, indicating clearly the changes incorporated therein.
- (ii) Provided always that the programme submitted in accordance with **Clause 9.1.3 (i)** [The Programme] shall be compiled to satisfy, without limitation, the following requirements:
- (a) each activity shown on the programme shall be defined in periods no longer than [30 (thirty)] days duration;
  - (b) the programme shall clearly identify all Milestone Events; and
  - (c) the programme shall contain a sub-network relating to all Related Works which shall clearly identify all interfacing activities and in particular those activities requiring an interface and coordination with Related Works Contractors.
  - (d) there shall be no artificial constraints on any dates and it should be possible to clearly identify the logic links to these dates;
  - (e) the Contractor shall incorporate activity codes and/or a work breakdown structure in the programme such that activities can be sorted and/or filtered by any or all of the following:
    - (1) the whole of the Works;





- (2) individual sections and interface areas;
  - (3) the various floor levels of the Works;
  - (4) the various areas within the Works as agreed with the NATIS Representative;
  - (5) the various areas within the Project Site and the project site of the Related works Contractor;
  - (6) various disciplines, including, the design and installation of civil and structural works, electrical and mechanical works (further broken down into electrical, mechanical, plumbing and drainage and fire stations) finishes (further broken down into screeding, flooring and floor finishes, false ceilings, raised floors, painting and decoration) and specialist systems;
- (f) it shall be possible to clearly identify each phase of each activity or group of related activities from the design, procurement, execution and testing stages.
- (iii) The Contractor shall with the said detailed programme, submit a supporting method statement and resource schedule, consistent with similar schedules submitted with the Tender, which shall include a programme narrative giving a general description of the methods which the Contractor intends to adopt in the Execution of the Works and details and measures that the Contractor has adopted to ensure its obligations under the Contract are fulfilled.
- 9.1.4 The Contractor and NATIS shall ensure that the detailed programme submitted in accordance with **Clause 9.1.3** [The Programme] shall be achievable and in compliance with the requirements of the Contract and that it shall permit effective monitoring of progress.
- 9.1.5 The Programme shall be the detailed programme submitted in accordance with **Clause 9.1.3** [The Programme] (including any programme re-submitted by the Contractor) and marked with "No Comments" or "comments made" in accordance with **Clause 6.3** [Contractor's Documents] provided, in the latter case, that the comments are fully addressed by the Contractor.
- 9.1.6 The Contractor shall design (to the extent required under the Contract) and Execute the Works regularly and diligently and in accordance with the Programme.
- 9.1.7 If, at any time, the NATIS Representative gives notice to the Contractor that the Programme fails (to the extent stated) to comply with the Contract or fails to be consistent with actual progress of the Works and the Contractor's stated intentions or will so fail, the Contractor shall submit to the NATIS Representative in accordance with **Clause 6.3** [Contractor's Documents] a revised Programme showing the modifications to the Programme as may be necessary to reflect actual progress of the Works and so as to ensure Completion by the





Time for Completion and to take account of any extensions of time granted in accordance with the Contract and any measures required to be taken by the Contractor to expedite the Works. The Contractor shall with the revised Programme in addition submit to the NATIS's Representative revisions to those documents referred to at **Clause 9.1.3 [The Programme]**.

- 9.1.8 Throughout the progress of the Works, the Contractor shall submit to the NATIS Representative monthly updates of the Programme and any documents which are included in or form part of the Programme.
- 9.1.9 Following the Notice to Proceed and throughout the progress of the Works, the Contractor shall submit to NATIS Representative in a format stipulated by NATIS Representative, a detailed monthly report on the progress of the Works.
- 9.1.10 The Contractor hereby acknowledges and accepts that any programme, monthly report, schedule and plan to be submitted by it in accordance with this **Clause 9 [The Programme]** shall not constitute a notice which it is required to give under any provision of the Contract.
- 9.1.11 The NATIS Representative's comment or failure to comment upon any document submitted in accordance with this **Clause 9.1 [The Programme]** signifies merely the understanding of the proposed order, sequence and method of working and shall not:
- (i) relieve the Contractor of any of its obligations under the Contract; nor
  - (ii) create any obligation or liability on the part of NATIS; nor
  - (iii) establish the Programme or any programme as part of the Contract.
- 9.1.12 In addition to the reports required under this **Clause 9.1 [The Programme]** the Contractor shall supply to the NATIS Representative at such times as the NATIS Representative may direct during the progress of the Works such further or special written particulars and information as are required by the NATIS Representative to enable proper and detailed progress records to be maintained in respect of the Works.
- 9.1.13 Subject to the foregoing, unless expressly stipulated or described in the Contract, the choice of methods of working, construction methods and Temporary Works, programming the Works and deployment of the Contractor's Equipment and employees on the Project Site shall be the sole responsibility of the Contractor.
- 9.1.14 It shall be a condition precedent to any payment under the Contract that the Contractor is able, pursuant to **Clause 6.3 [Contractor's Documents]** to proceed on the basis of the





programme submitted pursuant to **Clause 9.1.3 (i)** [The Programme] and monthly updates of the same.

## 9.2 “As built” drawings

9.2.1 The Contractor shall maintain a complete set of all Contractor's Documents used in the design and Execution of the Works.

9.2.2 The Contractor shall at the times, periods and stages required by Technical Specifications and Drawings or as directed by NATIS Representative, submit to NATIS Representative in accordance with **Clause 6.3** [Contractor's Documents] 2 (two) complete sets of the “as built” drawings of such part of the Permanent Works in the form specified in Technical Specifications and Drawings and other information in relation thereto as may be required by NATIS Representative.

## 9.3 Quality Assurance Plan

9.3.1 The Contractor shall, in a form and content acceptable to NATIS Representative, submit within [30 (thirty)] days of the Notice to Proceed, a Quality Assurance Plan to NATIS Representative. The Quality Assurance Plan shall incorporate the Testing Plans.

9.3.2 The Quality Assurance Plan shall be in accordance with Technical Specifications and Drawings.

9.3.3 The Contractor shall from time to time as reasonably required by NATIS Representative, submit amendments, revisions, supplements of the Quality Assurance Plan to NATIS Representative in accordance with **Clause 6.3** [Contractor's Documents].

9.3.4 The Contractor shall at its own cost provide all access, assistance and facilities to enable NATIS Representative to verify the implementation of the Quality Assurance Plan, other than the costs associated with travelling, lodging and boarding of NATIS Representative or its assistant(s)/ nominee(s).

## 10. REVIEW MEETINGS

10.1 Within the first week of every month from the issue of the Notice to Proceed during the Execution Period or at such intervals as NATIS Representative may direct, the Contractor shall meet with NATIS Representative and any of the Relevant Authority and any Related Works Contractors and any of their respective advisers as will be reasonably entitled to attend, to review the development of the design and Execution of the Works (“Review Meetings”).





- 10.2 The NATIS Representative shall, [7 (seven)] days prior to the date of a Review Meeting circulate an agenda (as agreed with NATIS Representative) to all those attending and copies of any Contractor's Documents or drawings, data or information of any kind to be presented at such meeting. All Review Meetings shall be chaired by NATIS Representative.
- 10.3 The Contractor shall take reasonable cognisance of any comments or objections raised at any Review Meeting by NATIS Representative, NATIS, any Relevant Authority, any Related Works Contractors and any of their respective advisers.
- 10.4 Following each Review Meeting, NATIS will prepare and circulate to those attending any such meeting a report listing the Contractor's Documents or drawings, data or information of any kind reviewed and a full minute with particular emphasis on any other design information discussed, any comments made and agreements reached.
- 10.5 Any comments or objections raised by the NATIS Representative at any Review Meeting shall be without prejudice to a review of any Contractor's Documents by the NATIS Representative in accordance with **Clause 6.3** [Contractor's Documents].

## **11. HEALTH, SAFETY, SECURITY AND ENVIRONMENT**

### **11.1 Importance of Safety**

- 11.1.1 The Contractor is under a general obligation to place the highest importance on the health, safety, security and environment aspects during the Execution of the Works. The Contractor shall establish a Health, Safety, Security and Environment Plan.
- 11.1.2 The Contractor shall be responsible for all Health, Safety, Security and Environment matters related to the Works and shall submit regular safety reports to NATIS Representative in accordance with the requirements of NATIS Representative under this Contract and all relevant Statutory Authorities and as required by Applicable Laws.

### **11.2 Contractor's Health, Safety, Security and Environment Plan**

- 11.2.1 The Contractor is under a general obligation to place the highest importance on safety during the Execution of the Works. The Contractor shall establish a safety programme to ensure that all activities required to undertake and to complete the design and Execution of the Works in accordance with the Contract are carried out in a safe manner and comply with Applicable Laws.





11.2.2 The Contractor shall submit regular safety reports to the NATIS Representative in accordance with the requirements of the NATIS Representative and all relevant Statutory Authorities and as required by Applicable Laws.

11.2.3 The Contractor's Health, Safety, Security and Environment Plan shall specify in detail:

- (i) the Contractor's approach to maintaining the safest possible work environment and ensuring protection against accident and injury to workers and other persons and protection of the Works, the Contractor's Equipment and other property from damage, loss or destruction and shall further include any requirements of the plan as set out in Technical Specifications and Drawings;
- (ii) the methods and procedures to be employed by the Contractor to ensure compliance with its obligations specified in Clause 11.3 [Environment Compliances] and shall address all relevant aspects of the Execution of the Works and the environmental management plan.

11.2.4 The Contractor shall from time to time as reasonably required by NATIS Representative, submit amendments, revisions, supplements of the Contractor's Health, Safety, Security and Environment Plan to NATIS Representative in accordance with Clause 6.3 [Contractor's Documents].

11.2.5 The Contractor shall provide all access, assistance and facilities to enable NATIS Representative to carry out surveillance visits both on and off the Project Site to verify that the Contractor's Health, Safety, Security and Environment Plan is being implemented.

### 11.3 Environmental Compliance

11.3.1 The Contractor shall comply with all environmental requirements stipulated in Technical Specifications and Drawings and with all Applicable Laws and regulations having application to the Project Facility, including but not limited to standards for noise and vibration levels and airborne and waterborne pollutants and the environmental management plan.

11.3.2 Without prejudice to the foregoing the Contractor shall carry out the Works in a manner:

- (i) which prevents unreasonable silting and erosion or pollution of or unauthorised discharges into any river, stream, waterway, drain, watercourse and in a manner which will not have any adverse effect on the Project Facility; and





- (ii) so as not to cause or knowingly permit contamination of any land, either on or off any part of the Project Site, by any deliberate or accidental disposal, including leakage or spillage of any effluent, pollutant, contaminant, flammable, corrosive, radioactive or otherwise hazardous substance and waste.

11.3.3 In the event of the occurrence or suspected occurrence of an incident caused by the Execution of the Works or otherwise by the Contractor which could give rise at any time to any environmental damage or damage to the Works or the Project Facility, the Contractor shall:

- (i) immediately notify NATIS Representative of such incident and shall comply with any instruction of NATIS Representative relating to the incident;
- (ii) take and complete promptly whatever action is required to prevent, mitigate or remedy any such environmental damage including any actions required under Applicable Laws in such situations; and
- (iii) investigate the incident, and following such investigation, report to NATIS Representative the details of the incident and the results of such incident.

11.3.4 The Contractor shall, promptly and diligently comply with any instruction issued by NATIS Representative under this Clause 11.3 [Environmental Compliance].

#### 11.4 Fencing, lighting and guarding

11.4.1 The Contractor shall consult with any relevant Statutory Authority and shall take all reasonable and proper steps for protecting, securing, lighting and watching all places on or about the Works and the Project Site which may be dangerous to any person on the Project Site or to any member of the public and maintain at its own cost all lights, guards, fencing and watching when and where necessary or required by NATIS Representative or by any relevant Statutory Authority for the protection of the Works or for the safety and convenience of all persons on the Project Site and members of the general public.

11.4.2 The Contractor shall take such measures in accordance with Technical Specifications and Drawings and Good Industry Practice to prevent access onto the Project Site of any persons or creatures not entitled to be there.

#### 11.5 Major laws

Some of the major laws that are applicable as regards to Safety, Security and Protection of the Environment and the Contractor shall abide are given below:

**The Water (Prevention and Control of Pollution) Act. 1974**





This provides for the prevention and control of water pollution and the maintaining and restoring of wholesomeness of water. Pollution means such contamination of water or such alteration of the physical, chemical or biological properties of water or such discharge of any sewage or trade effluent or of any other liquid gaseous or solid substance into water (whether directly or indirectly) as may, or is likely to create a nuisance or render such water harmful or injurious to public health or safety, or to domestic, commercial, industrial, agricultural or other legitimate uses or to the life and health of animals or plants or of aquatic organisms.

#### **The Air (Prevention and Control of Pollution) Act. 1981**

This provides for prevention, control and abatement of air pollution 'Air Pollution' means the presence in the atmosphere of any 'air pollutant' which means any solid, liquid or gaseous substance (including noise) present in the atmosphere in such concentration as may be or tend to be injurious to human beings or other living creatures or plants or property or environment.

#### **The Environment (Protection) Act. 1986**

This provides for the protection and improvement of environment and for matters connected therewith and the prevention of hazards to human beings, other living creatures, plants and property. 'Environment' includes water, air and land and the inter-relationship which exists among and between water, air and land, and human beings, other living creatures, plants, micro-organism and property.

#### **The Public Liability Insurance Act. 1991**

This provides for public liability insurance for the purpose of providing immediate relief to the persons affected by accident occurring while handling hazardous substances and for matters connected herewith or incidental thereto. Hazardous substance means any substance or preparation which is defined as hazardous substance under the Environment (Protection) Act 1986, and exceeding such quantity as may be specified by notification by the Central Government.

## **12. ELECTRICITY, WATER**

### **12.1 General arrangements**

12.1.1 The Contractor shall be responsible for making all its arrangements, for and paying all charges in connection with the supply and consumption of electricity and water and the disposal of sewage and other waste as may be necessary for the design and Execution of the Works including the construction, erection, testing and commission of the Project Facility at a convenient point within the Project Site which enables the Contractor to carry on its obligations under this Contract without any hindrance. The Contractor shall be responsible for laying a distribution network according to the Contractor's requirement and shall bear any charges for the utilisation of water and electricity.



12.1.2 Connection of any part of the Permanent Works with utility services such as electricity, water and sewerage services shall be made in accordance with Technical Specifications and



Drawings or as NATIS Representative may reasonably direct. Without prejudice to the generality of the foregoing and without prejudice to its obligations under **Clause 13 [Related Works]** the Contractor shall during the Execution Period:

- (i) review with NATIS Representative and the Related Works Contractors and other Statutory Authorities the design of the power, water and sewage, gas, telephone, optical fibres interconnections and the construction schedule therefore and shall design, construct and commission such power, water and sewage interconnections to achieve complete compatibility with the design of the power and water interconnections and related equipment of the Related Works Contractor; and
- (ii) liaise, co-ordinate and programme with the Related Works Contractor to avoid delays in connecting the Permanent Works to the permanent power and water connections and supply for the Project Facility.
- (iii) liaise, co-ordinate and programme with the Related Works Contractor to avoid delays in connecting the Permanent Works to the permanent power connections and supply for the Project facility;

## **13. RELATED WORKS**

### **13.1 Acknowledgement**

The Contractor acknowledges that Related Works shall be performed and that it is of paramount importance that the design and Execution of the Works are fully and completely co-ordinated with the Related Works in view of their concurrent and sequential nature and that such coordination is of the utmost importance to the successful integration of the Works with the Related Works and to the timely completion of the Project Facility. Without prejudice to the foregoing or to **Clause 1.5 [Background Information and the manner in which discrepancies are resolved]** the Contractor warrants that it has conducted its own analysis and review of the Background Information in respect of the design and execution of Related Works and that it has satisfied itself that there are no ambiguities, discrepancies, inconsistencies, divergence, design or construction impracticalities or omissions from, with and between the same and the documents comprising the Contract.

### **13.2 Related Works' responsibilities**

Accordingly, the Contractor shall at its own cost and expense, at all times and otherwise in accordance with the reasonable requirements and directions of the NATIS Representative:

- 13.2.1 take all reasonable steps to co-ordinate and to integrate the design and Execution of the Works, including the work of Subcontractors, with the activities of the Related Works Contractors, and in particular to liaise, consult and co-operate with all authorised parties





responsible for the Related Works including the preparation of joint programmes, method statements, co-ordination drawings, specifications; and

- 13.2.2 convene such co-ordination meetings as are necessary to plan, review and determine co-ordinated activities for the management of interfaces between the Works and the Related Works; and
- 13.2.3 plan, programme, and schedule the Works so as to minimise any interference with or hindrance to the Related Works; and
- 13.2.4 at all times refrain from carrying out any operation on the Project Site in a manner which is likely to cause damage or inconvenience to the execution of the Related Works; where such damage or inconvenience is the unavoidable consequence of operations properly to be carried out on the Project Site, the Contractor shall not carry out such operations without first giving reasonable advance notice in writing thereof to the NATIS Representative (with a copy to those responsible for carrying out the Related Works reasonably likely to be affected thereby) with a view to reaching an agreed procedure to prevent or minimise any such damage or inconvenience; and
- 13.2.5 to take at all times every necessary step to protect the Related Works from accidental damage caused by the Works; and
- 13.2.6 at all times co-operate with NATIS and any Related Works Contractors so as to promote and foster a co-ordinated and integrated approach to the Works and the Related Works. The Contractor shall co-ordinate its activities with Related Works Contractors so as to prevent, as far as possible, the performance of work by such Related Works Contractors from impeding the performance of the Contractor or unreasonably disturbing the free movement of traffic around, on or in the vicinity of the Project Site; and
- 13.2.7 comply with all obligations as to interfacing the Works with the Related Works as are detailed in Technical Specifications and Drawings; and
- 13.2.8 advise NATIS and Related Works Contractors if it is anticipated that the programme of any Related Works Contractor will prevent the Contractor from designing and Executing the Works in accordance with the Contract and, if so, shall make recommendations or suggestions as to how the programme of the Works may be adjusted without affecting the Related Works, to enable the Contractor to meet its obligations hereunder; and
- 13.2.9 advise the Contractor if any plans, designs, specifications and drawings of the Related Works Contractors supplied by NATIS are in any way incompatible or inconsistent with or otherwise detrimental to the Works. In the case of such established incompatibility, inconsistency or detriment NATIS shall supply the Contractor with full details of the same





and make appropriate recommendations as to how the incompatibility, inconsistency or detriment may be remedied; and

- 13.2.10 monitor the coordination and integration of the Works with the Related Works and advise NATIS in writing as and when it becomes apparent that the design or Execution of the Works is likely to be the subject of delay and/or disruption and recommend reasonable proposals to reduce or prevent such delay and/or disruption.

### 13.3 Co-ordination meetings

Without prejudice to the Contractor's obligations under **Clause 13.2** [Related Works' responsibilities] the NATIS Representative shall convene regular co-ordination meetings with the Contractor and Related Works Contractors in order to:

- 13.3.1 plan, review and determine co-ordinated activities for the management of interfaces between the Works and the Related Works, including those proposals of the Contractor submitted pursuant to **Clause 9.1** [The Programme]; and
- 13.3.2 discuss and resolve conflicts in the order and sequence of the Works and Related Works in order to effect reasonable co-ordination and integration of the Execution of the Works with the execution of the Related Works; and
- 13.3.3 advise the Contractor of further developments in respect of the Project Facility including where appropriate, details of Related Works.

### 13.4 Allowance in the Contract Sum

The Contractor shall be deemed to have made adequate allowance in the Contract Sum and in the Programme for compliance with its obligations under this **Clause 13** [Related Works] and for any interference with the progress of the design (to the extent required under the Contract) and Execution of the Works caused by Related Works and for all expenses arising in relation to provision of access and co-operation for the purposes of this **Clause 13** [Related Works].

### 13.5 Failure to co-ordinate

In the event that the design (to the extent required under the Contract) and the Execution of the Works and the design and execution of the Related Works are not being co-ordinated and integrated to the reasonable satisfaction of NATIS, NATIS may issue such instructions as are necessary including, but not limited to:





- 13.5.1 suspending the progress of the design or Execution of the Works or any part thereof; and/or
- 13.5.2 changing the Works including the omission of work from the Contract and its execution by others.

For the avoidance of doubt, where NATIS acting reasonably, determines that an instruction under this Clause 13.5 [Failure to Co-ordinate] is required as a result of a breach by the Contractor of its obligations under this Clause 13 [Related Works] the Contractor shall not be entitled to any payment whatsoever in respect of any such instruction or to any extension of time in respect thereof and the costs to NATIS of such instruction including the cost of any such suspension, or removal and execution by others shall, without prejudice to NATIS's other rights under the Contract, be deducted from the Contract Sum.

### 13.6 The NATIS Representative's assistance

13.6.1 In the event that the design and Execution of the Works and the design (if any) and execution of any Related Works are unable to be co-ordinated and integrated in accordance with this Clause 13 [Related Works] as a result of circumstances beyond the control of the Contractor, the Contractor may, along with the submission of a report, request the NATIS Representative:

- (i) to issue within [10 (ten)] days of the Contractor's request, such instructions as the NATIS Representative may consider necessary to enable the Contractor to comply with its obligations under this Clause 13 [Related Works]; and/or
- (ii) to use its reasonable endeavours to assist in procuring the removal of the hindrance or impedance preventing the Contractor from complying with its obligations under this Clause 13 [Related Works].

### 13.7 Contractor to bear costs

The Contractor shall bear all costs and expenses associated with any Change or remedied work rendered necessary to the design (to the extent required under the Contract) or Execution of the Works or the work of any Related Works Contractor as a result of any failure on the Contractor's part to comply with the provisions of this Clause 13 [Related Works]. Subject always to this Clause 13 [Related Works], if in the opinion of NATIS Representative any cost is or is likely to be incurred as a result partially of a failure by the Contractor and partially as a result of a failure by a Related Works Contractor, then in the event that the Contractor and the Related Works Contractor are unable to agree on the apportionment of such costs between them, the NATIS Representative may instruct the Contractor to make a Change or carry out any repair it deems necessary and, notwithstanding the provisions of Clause 23 [Change] in valuing such Change or repair, it shall be entitled to make what it, in its absolute discretion considers a fair reduction, in any payment to the Contractor to reflect its assessment of the Contractor's responsibility for the



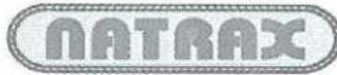

necessity to make such Change or repair as a result of the Contractor's failure to comply with the requirements of this **Clause 13 [Related Works]**.

### **13.8 Contractor's obligations**

Without limiting its obligations under this **Clause 13 [Related Works]** or **Clause 6 [The Contractor]**, the Contractor shall exercise due care and diligence in the design and Execution of the Works where such design and Execution of the Works affects or is likely to affect the Related Works and shall bear all costs, expenses, damages and losses suffered by any Related Works Contractor as a result of its failure to comply with such obligations.

### **13.9 Contractor's indemnities**

The Contractor shall indemnify and keep indemnified NATIS against all claims, proceedings, damages, costs, losses, charges and expenses of any nature whatsoever arising from the Contractor's failure to comply with its obligations under this **Clause 13 [Related Works]**.

### **13.10 Temporary Works**

The Contractor shall be fully responsible for the cost of all delays to the Works or any part where such delays have been occasioned to or in connection with Temporary Works by the defaults or omissions of any Related Works Contractor and it shall not be entitled to any extension of time or additional payment in respect thereof. Such responsibility shall in no way be in derogation of the Contractor's other obligations under this **Clause 13 [Related Works]**.

## **14. DELIVERY TO THE PROJECT SITE**

### **14.1 Delivery to the Project Site**

14.1.1 The Contractor shall at its own risk and expense, be fully responsible for the proper packing, marking, loading, transportation, customs clearance, delivery to the Project Site, unloading and proper storage and security of all Contractor's Equipment, Temporary Works and Materials required for the purposes of the Contract and for or in connection with the Works and for making all arrangements in connection therewith and for the reception thereof on the Project Site.

14.1.2 When marking any Contractor's Equipment, Temporary Works and Materials, the Contractor shall be responsible for ensuring that all such equipment and any part thereof and their transportation containers are properly marked and consigned.





#### 14.2 Packing List

A packing list itemising the contents of each case shall be enclosed in each package. A copy of the packing list, together with despatch details shall be provided forthwith upon despatch to the NATIS Representative. The Contractor shall provide all attendance, handling and transport up to and including off loading into the appropriate Project Site storage area.

#### 14.3 Importation

The Contractor shall be responsible at its own cost for obtaining any Applicable Clearances necessary for the export of Contractor's Equipment, Temporary Works and Materials from the country of origin and any Applicable Clearances necessary for their importation into India and the re-export from India of Contractor's Equipment as may be the case.

#### 14.4 Customs Clearance

NATIS will use its reasonable endeavours in assisting the Contractor, where required, in obtaining the customs clearance of any Contractor's Equipment, Temporary Works and any Materials required for the Works.

#### 14.5 Documents

Upon despatch of each shipment of significant items of Materials and Contractor's Equipment, the Contractor shall notify the NATIS Representative by facsimile or email of the description of the Materials and the Contractor's Equipment and the point and means of the despatch and the estimated time and point of delivery at the Project Site and the Contractor shall furnish NATIS with all relevant transportation, insurance and testing documentation in respect of such equipment, including without limitation:

14.5.1 ocean bills of lading;

14.5.2 commercial invoices;

14.5.3 packing lists;

14.5.4 insurance policy certificate;

14.5.5 certificate of origin;





14.5.6 inspection and test certificate;

14.5.7 customs declaration details.

The ocean bill of lading must be a full set of "clean on-board" bill of lading.

## 15. CONTRACTOR'S EQUIPMENT AND OTHER PROVISIONS

### 15.1 Contractor's Equipment and Temporary Works

15.1.1 All Contractor's Equipment and Temporary Works provided by the Contractor or its Subcontractors shall, when brought on to the Project Site, be deemed to become the property of NATIS in the event of Termination of Works on account of default of the Contractor and to be exclusively intended for the design and Execution of the Works and the Contractor shall not remove the same or any part thereof, except for the purpose of moving it from one part of the Project Site to another, without the consent of the NATIS Representative. Provided that such consent shall not be required for vehicles engaged in transporting any staff, labour, Contractor's Equipment and Temporary Works to or from the Project Site.

15.1.2 The Contractor shall upon written request by the NATIS Representative produce to the NATIS Representative all documents evidencing title to or the contractual basis of the Contractor's right to use any item of Contractor's Equipment. In the event of failure to comply with such a request within [7 (seven)] days, without prejudice to any other rights or remedies available to NATIS, NATIS may withhold any payments otherwise due to the Contractor in accordance with the Contract.

### 15.2 NATIS not liable for damage

NATIS shall not at any time be liable for the loss of or damage to any of the Contractor's Equipment and Temporary Works.

### 15.3 Conditions of hire of Contractor's Equipment

15.3.1 With a view to securing, in the event of Termination, the continued availability, for the purpose of Executing the Works, of any hired Contractor's Equipment, the Contractor shall not bring on to the Site any hired Contractor's Equipment unless there is an agreement for the hire thereof (which agreement shall be deemed not to include an agreement for hire purchase) which contains a provision that the owner will, on request in writing made by NATIS within [7 (seven)] days after the Termination Date and on NATIS undertaking to pay all hire charges in respect thereof from such date, hire such Contractor's Equipment to NATIS on the same terms in all respects as the same was hired to the Contractor, save that





NATIS shall be entitled to permit the use thereof by any other contractor employed by it on occasion of the Contractor's termination.

- 15.3.2 The Contractor shall upon request made by the NATIS Representative at any time in relation to any item of hired Contractor's Equipment immediately notify to the NATIS Representative in writing the name and address of the owner thereof and shall certify that the contract for the hire thereof contains a provision in accordance with the requirements of Clause 15.3.1 [Conditions of hire of Contractor's Equipment]. The Contractor shall also upon request as aforesaid give a like notification (but without certification) in regard to any Contractor's Equipment held under a contract of hire purchase thereof.
- 15.3.4 In the event of NATIS entering into any agreement for the hire of Contractor's Equipment pursuant to Clause 15.3.1 [Conditions of hire of Contractor's Equipment] all sums properly paid by NATIS under the provisions of any such agreement and all costs incurred by it (including stamp duties) in entering into such agreement shall be deemed to be part of the costs of Executing the Works.

#### **15.4 Hire purchase payments by NATIS**

NATIS, shall in order to avoid seizure by the owner of any Contractor's Equipment held under a contract of hire purchase thereof, be entitled to pay to such owner the amount of any overdue instalment or other sum payable under any contract for hire purchase and in the event of its doing so any amount so paid by NATIS shall be a debt due from the Contractor to NATIS and may be deducted by NATIS from any monies due or that may become due to the Contractor under the Contract or may otherwise be recovered by NATIS from the Contractor.

#### **15.5 Re-export of Contractor's Equipment**

In respect of any Contractor's Equipment which the Contractor imports for the purpose of the Execution of the Works, the NATIS Representative will use its reasonable endeavours to assist the Contractor if so requested and to the extent it is able to do so in procuring any Applicable Clearances for the re-export of such Contractor's Equipment by the Contractor upon the removal thereof as aforesaid.

#### **15.6 Approval not implied**

The operation of this Clause 15 [Contractor's Equipment and Temporary Works] shall not be deemed to imply any approval by the NATIS Representative of the Contractor's Equipment and/or the Temporary Works or any part thereof, or other matters referred to therein nor shall it prevent the NATIS Representative's right to order the removal of any such Contractor's Equipment and/or Temporary Works or part thereof, at any time.





## 15.7 Incorporation of Clause into Subcontracts

The Contractor shall, where entering into any Key Subcontract or Major Subcontract for the Execution of any part of the Works, incorporate in such Subcontract (by reference or otherwise) the provisions of this Clause 15 [Contractor's Equipment and Temporary Works] in relation to plant, equipment and Materials and tools and Temporary Works brought on to the Project Site by the Subcontractor.

## 15.8 Re-vesting and removal of Contractor's Equipment

Upon removal of any Contractor's Equipment and Temporary Works which have been deemed to become the property of NATIS under Clause 15.1 [Contractor's Equipment and Temporary Works] with the NATIS Representative's consent, as aforesaid, the property therein shall be deemed to re-vest in the Contractor and upon Completion of the Works the property in the remainder of such Contractor's Equipment and Temporary Works as aforesaid shall, subject to the termination provisions of the Contract, re-vest in the Contractor who shall remove the same. If the Contractor shall fail to remove any Contractor's Equipment or Temporary Works as aforesaid within such reasonable time after Completion of the Works as may be allowed by the NATIS Representative or should fail to comply with its obligations under Clause 15.3.1 [Upon Termination], NATIS may:

15.8.1 sell any such Contractor's Equipment and Temporary Works; or

15.8.2 return any hired Contractor's Equipment at the Contractor's expense to the person, firm or company from whom such Contractor's Equipment was hired by the Contractor

and after deducting from any proceeds of sale the cost, charges and expenses of and in connection with such sale and in connection with such return as aforesaid, NATIS shall, subject to any right of set-off, pay the balance (if any) to the Contractor but to the extent that the proceeds of any sale or return are insufficient to meet all such costs, charges and expenses the excess shall be a debt due from the Contractor to NATIS and shall be deductible or recoverable by NATIS accordingly as aforesaid.

## 16. LABOUR AND CONTRACTOR'S PERSONNEL

### 16.1 Labour Compliances

16.1.1 In the employment of labour for the Execution of the Works the Contractor shall comply and shall require its Subcontractors to comply without limitation, with all requirements of any Applicable Law relating to the employment of workmen or any subsequent modification or re-enactment thereof including but not limited to, matters relating to timely payment of wages and allowances, payment of minimum wages, payment of overtime, grant of leave, payment of workmen's compensation, working hours, safety, maternity benefits, holidays,





framing of standing orders, disciplinary action against employees, payment of provident fund contributions, payment of gratuities and payment of bonus.

16.1.2 The Contractor shall be responsible for making all arrangements for the payment, feeding, housing, health, safety, sanitation and transport of all labour. The Contractor shall be responsible for labour camps, preservation of peace, sanitary arrangements, infectious diseases, medical facilities at site, use of intoxicants, age limits of labour, observance of peace, etc.

16.1.3 Provision of labour camp

The Contractor, shall, at his own expense, make adequate arrangements for the housing, supply of drinking water, canteen and provision of latrines and urinals, for his staff and workmen employed on the Works, directly or through petty Contractors or sub-Contractors and for temporary creche (Bal-mandir) where 50 or more women are employed at a time. All camp sites shall be maintained in a clean and sanitary condition, by the Contractor, at his own cost.

16.1.4 Compliance with Rules for Employment of Labour

The Contractor shall comply with all laws, bylaws, rules and regulations, for the time being in force, pertaining to the employment of local or imported labour, and shall take all necessary precautions to ensure and preserve the health and safety of all staff, employed on the Works directly or through petty Contractors or Sub-Contractors.

16.1.5 Preservation of Peace

The Contractor shall take requisite precautions, and use its best endeavors to prevent any riotous or unlawful behavior by or amongst his workmen, and others, employed on Works directly or through petty Contractors or assignees or Subcontractors and for preservation of peace and protection of the inhabitants and security of property in the neighborhood of Works. In the event of NATIS requiring the maintenance of a Special Police Force at or in the vicinity of the Project Site, during the tenure of works, the expenses thereof shall be borne by the Contractor and if paid by NATIS, shall be recoverable from the Contractor.

16.1.6 Sanitary Arrangements

The Contractor shall obey all sanitary rules, and carry out at his cost all sanitary measures that may from time to time be prescribed by the Local Medical Authority, and permit inspection of all sanitary arrangements at all times by the NATIS Representative or the Medical staff of NATIS and the staff of the local municipal or other authorities concerned.





Should the Contractor fail to make adequate sanitary arrangements, these will be provided by NATIS, and the cost thereof recovered from the Contractor.

#### 16.1.7 Outbreak of infectious Diseases:

The Contractor shall maintain the Labour Camp in a sanitary condition taking all necessary precautions to detect the outbreak of infectious diseases. The Contractor shall provide them with suitable prophylactics for the prevention of malaria, gastroenteritis, typhoid and other water-borne diseases.

The Contractor shall remove from the Contractor's camp such labour and their families, who refuse protective inoculation and vaccination, when called upon to do so by the NATIS Representative or the NATIS Representative's representative on the advice of medical authority. Should Cholera, Plague or any other epidemic, contagious or infectious disease break out, the Contractor shall on its own burn the huts, beddings, clothes and other belongings of or used by the infected persons, and promptly erect new huts on healthy sites as required by the NATIS Representative, within the time specified by the NATIS Representative's requisition, failing which the same may be done by NATIS and cost thereof recovered from the Contractor.

#### 16.1.8 Medical Facilities at Site:

The Contractor shall, at its own cost, provide First Aid and medical facilities, at the Project Site as may be prescribed by the NATIS Representative, on advice of Medical Authority in relation to the strength of the Contractor's staff and workmen employed on the Works, directly or through petty Contractors or Sub-Contractors.

#### 16.1.9 Use of Intoxicants:

The sale of ardent spirits or other intoxicating drugs or beverages upon the Works, or in any of the buildings, encampments or tenements owned or occupied, by or within the control of the Contractor or any of his employees employed on the Works directly or through petty Contractors or sub-Contractors shall be forbidden, and the Contractor shall exercise its influence and authority to secure strict compliance with this condition. The Contractor shall also ensure that no labour or employee is permitted to work at the Project Site in an intoxicated state or under the influence of drugs.

#### 16.2 Contractor to indemnify

The Contractor shall indemnify NATIS against any claim for legal action arising out of the Applicable Laws due to the failure of non-compliance of the provisions of the Applicable Laws which arise out of or in connection with the employment of any labour for the Execution of the Works and penalty or any other amount levied by the authorities from





NATIS, shall be recoverable form the payments due to the Contractors or from the security deposit or both, as debt due and payable on demand.

### 16.3 Engagement of Labour

The Contractor shall make its own arrangements for the engagement of all labour, local and otherwise, skilled, semi-skilled and unskilled, as may be required for the proper and timely Execution of the Works and shall use all diligence in arranging for a sufficient and suitable supply of such labour but all such arrangements in India shall be in accordance with the general local usage and subject to the Applicable Laws.

### 16.4 Project Site records and returns

The Contractor shall maintain and keep at the Project Site wage books and time sheets showing the wages paid to and time worked by all labour employed by the Contractor and its Subcontractors in and about the Execution of the Works or any part thereof and all records, forms, declarations, registers, notices, and copies of filings made with labour authorities as are required to be maintained by the Contractor pursuant to the Applicable Laws and the Contractor shall produce such wages books, time sheets and records for inspection by NATIS Representative or any representative of a Statutory Authority.

### 16.5 Contractor's Personnel

#### 16.5.1 General

The Contractor shall at all times ensure that it has sufficient, suitable and qualified personnel at the Project Site and in sufficient number to undertake the responsibilities imposed upon the Contractor under the Contract and to provide full attention to the design and Execution of the Works.

#### 16.5.2 The Contractor's Project Organisation Chart

16.5.2.1 The Contractor's Project Organisation Chart to be submitted by the Contractor to the NATIS Representative in accordance with Clause 3.3.1 [Following the Notice to Proceed] shall show the proposed organisation to be established by the Contractor for carrying out the Works and shall be consistent with the Contractor's project organisation chart submitted with the Tender submission. The chart shall evidence that the Contractor has the requisite organisation in place and that it has designated and proposed suitable persons as Key Personnel, whose identities and bio-data it shall include with the Contractor's Project Organisation Chart, to supervise the design and





Execution of the Works and to deal with NATIS, the NATIS Representative and any Statutory Authority, as appropriate.

16.5.2.2 The Contractor shall promptly notify the NATIS Representative of any proposed revision or alteration of the Contractor's Project Organisation Chart, which shall be submitted to the NATIS Representative in accordance with Clause 6.3 [Contractor's Documents].

### 16.5.3 Key Personnel

16.5.3.1 The NATIS Representative shall be entitled to interview any or all of the persons designated and proposed as Key Personnel before deciding whether or not to consent to their appointment. If NATIS interviews any of the proposed Key Personnel, NATIS shall be deemed to consent to such Key Personnel if it makes no objection within [3 (three)] days of the interview of the last proposed person to be interviewed. If NATIS objects to any of the proposed Key Personnel within such 3 (three) day period, then the Contractor must nominate a replacement or replacements, as applicable within [7 (seven)] days and this Clause 16.5.3.1 [Key Personnel] applies to such nomination.

16.5.3.2 The Key Personnel are to be engaged throughout the period of the Contract and shall include one or more of the following positions as set out in the Special Conditions of Contract:

- (i) a representative who shall be resident in a location convenient to the Project Site, to give its whole time to the superintendence of the Works, to be in full charge thereof and who shall be empowered by the Contractor to act on the Contractor's behalf in all matters in relation to the Contract. Such representative shall be known as the "Project Manager";
- (ii) on the Works at the Project Site, a sub-representative who shall give its whole time to the superintendence of the same. Such representative shall be known as the "Construction Superintendent";
- (iii) a suitably qualified and experienced person to be known as the "Project Site Safety Officer", to act as manager of the Contractor's Project Site Safety Plan and be responsible for all safety matters related to the Works;
- (iv) a suitably qualified and experienced person at the Project Site to be known as the "Environmental Compliance Manager" to ensure the effective implementation of the Contractor's Environmental Management Plan;





- (v) a suitably qualified and experienced person to be known as the "Quality Assurance Manager", to act as manager of the Quality Assurance Plan and be responsible for all quality matters related to the Works; and
- (vi) a suitably qualified and experienced person to be known as the "Design Co-ordinator", to act as co-ordinator of the design.

16.5.3.3 Every Key Personnel shall:

- (i) be empowered to receive and shall receive on behalf of the Contractor, decisions, directions, orders and instructions given to it by the NATIS Representative;
- (ii) be fluent in the English language;
- (iii) be available to discuss, explain or make presentations on any part of the Works for which it is responsible; and
- (iv) be competent and authorised by the Contractor.

16.5.3.4 The Contractor may only remove or replace a member of the Key Personnel with the prior written consent of NATIS, provided that any substitute personnel must be qualified for the duties of the position and there is an uninterrupted transition between the Key Personnel and their replacement.

#### 16.5.4 English speaking persons

The Contractor shall provide and shall, if so required by the NATIS Representative, procure that any Subcontractor shall provide competent and authorised English speaking persons, approved by the NATIS Representative, on all parts of the Works (including premises where design is being undertaken) where work is in progress, whose English shall be sufficiently fluent to allow them to discuss and explain the technical aspects and design of the part of the Works in question.

#### 16.5.5 Technical Assistants

16.5.5.1 The Contractor and, where appropriate any Subcontractor shall provide and employ in connection with the design and Execution of the Works only such engineers and technical assistants as are skilled and experienced in their respective callings and such engineers, managers, sub-representatives, foremen and leading hands as are competent to give proper supervision to the work they are required to supervise.





16.5.5.2 All the Contractor's engineers and technical assistants and other personnel, who are required to deal directly with the NATIS Representative or any delegate or assistant of the NATIS Representative, or their respective senior staff shall:

- (i) not be transferred from the Works without the prior written approval of the NATIS Representative;
- (ii) be named and listed, along with the Key Personnel, in the Contractor's Project Organisation Chart; and
- (iii) be fluent in the English language, and when appropriate in the NATIS Representative opinion, in the predominant language of the labour force.

#### 16.5.6 Removal of Contractor's employees

The NATIS Representative may object to and require the Contractor to immediately remove from the Works at the Contractor's expense any person employed by the Contractor or its Subcontractors in relation to the Works and such person shall not be employed again upon the Works without the written permission of the NATIS Representative. Any person so removed from the Works shall, unless the NATIS Representative specifies otherwise, be replaced, at the Contractor's expense as soon as possible by a competent substitute approved by the NATIS Representative.

#### 16.5.6 Contractor to maintain discipline

The Contractor shall at all times be responsible for the discipline of its employees and those of its Subcontractors and for ensuring that they perform their duties in a safe, orderly and clean manner in accordance with the requirements of the NATIS Representative.

16.6 Subject to Clause 16.5.3.1, the contractor may bring in to the Country any foreign personnel who are necessary for the execution of the Works to the extent allowed by the applicable Laws. The Contractor shall ensure that these foreign personnel are provided with the required residence visas and work permits. The Employer will, if requested by the Contractor, use his best endeavours in a timely and expeditious manner to assist the Contractor in obtaining any local, state, national, or government permission required for bringing in the Contractor's personnel.

The Contractor shall be responsible for the return of these foreign personnel to the place where they were recruited or to their domicile. In the event of the death or disability of any of the foreign personnel or members of their families during or in connection with the Execution of Works, the Contractor shall be solely responsible for making the appropriate arrangements for their return or burial and shall be completely liable for any claims for compensation/ legal proceedings by such foreign personnel or their family (as the case may be) in relation to such disability/ death without any liability whatsoever to NATIS or the





NATIS Representative and the Contractor shall indemnify NATIS in case NATIS is held liable under any Applicable Law and/ or any court order for such burial/ return or claims of the foreign personnel or the family of such foreign personnel.

## 17. TESTING / INSPECTION

### 17.1 General

- 17.1.1 All materials, works and workmanship shall be of the respective kinds and standards described in the Contract and in accordance with NATIS Representative's instructions and shall be subjected from time to time to such tests / Inspections as provided for in the Contract. The Contractor shall provide such assistance, instruments, machines, consumables and artificial loads and labour and materials as are normally required for examining, measuring and testing any work and the quality, weight or quantity of any material used and shall supply samples of materials before incorporation in the Works for testing as set out in the Testing Plans.
- 17.1.2 The Testing / Inspection Plans being a part of the Quality Assurance Plan, shall be submitted to NATIS Representative in accordance with **Clause 6.3** [Contractor's Documents] at the times and in the manner stated in the Contract or as otherwise directed by NATIS Representative. Where the Contractor is able to proceed on the basis of the Testing / Inspection Plans submitted in accordance with **Clause 6.3** [Contractor's Documents], all tests and inspections shall be conducted in accordance with the said Testing / Inspection Plans. In preparing the Testing / Inspection Plans, the Contractor shall define the tests / Inspections which it is to perform in accordance with the tests / Inspections set out in this **Clause 17** [Testing / Inspection].
- 17.1.3 Notwithstanding **Clause 17.1.2** [General], the NATIS Representative may, if it considers it appropriate or necessary, at any time change the requirements for inspection and/or testing, in which event it shall so inform the Contractor in writing and the Contractor shall forthwith give effect to such change, including submitting any Testing / Inspection Plans to the NATIS Representative in accordance with **Clause 6.3** [Contractor's Documents] and the provisions of **Clause 17.2** [Testing Costs] shall apply.
- 17.1.4 Any notice (Request for Inspection / Testing [RFI/RIT], wherever applicable) which must be given by the Contractor to NATIS Representative in accordance with the Contract with respect to the Contractor's intention to carry out any tests / Inspection must include details of:
- (i) the item / works to be tested / Inspected;
  - (ii) the test / Inspection to be performed; and
  - (iii) the proposed date and location of the test / Inspection, provided always the Contractor shall give notice of the date of any test Inspection in accordance with





Technical Specifications and Drawings or as otherwise directed by NATIS Representative.

17.1.5 NATIS Representative or its nominee and any other person designated by NATIS may attend and witness any test / Inspection.

17.1.6 The Contractor agrees that neither the execution of any test nor the issue of any test certificate / acceptance of Inspection report (RFI/RTI) releases the contractor from any of its responsibilities, obligations, or liabilities (including repair or replacement of any equipment or part of the works damaged during the carrying out of any tests / rejected during inspection) under the Contract.

## 17.2 Testing Costs

The cost of making any test or inspection under the Contract shall be borne by the Contractor if such test or inspection is intended by or provided for in the Contract or should have reasonably been anticipated by the Contractor as likely to be required. Any accommodation and travel costs incurred by NATIS or its agents in attending tests and inspections shall be borne by NATIS.

Save, as aforesaid, where any test is ordered by the NATIS Representative which is neither intended nor provided for by the Contract nor could reasonably have been anticipated by the Contractor, then the cost of such test shall be borne by the Contractor if the test shows any design, workmanship or materials not to be in accordance with the Contract or the NATIS Representative's instructions, or if the test was required as a result of any failure of the Contractor to comply with its obligations under the Contract.

## 17.3 Project Site Tests

17.3.1 The Contractor must:

- (i) Procure the carrying out of the Project Site Tests; and
- (ii) Not allow an item of Materials to be transported to the Project Site unless it has successfully completed the Tests during Manufacture.

17.3.2 Within [7 (seven)] days of completion of any Project Site Tests, the Contractor must give the NATIS Representative a report of the test results in a form approved by the NATIS Representative.





17.3.3 The NATIS Representative may, within [7 (seven)] days of receipt of a report produced in accordance with **Clause 17.3.2 [Project Site Tests]**, give the Contractor a notice that it considers:

- (i) such report is deficient in any way, and that it directs the Contractor to correct and re-submit the report and the Contractor must re-submit the report;
- (ii) in its reasonable opinion, that the Contractor has failed the test; or
- (iii) that the relevant test has been successfully performed.

17.3.4 If, in the reasonable opinion of the NATIS Representative, the Works fail any Project Site Test, the Contractor must:

- (i) give the NATIS Representative notice of the cause of the failure and the remedial action to be taken;
- (ii) remedy the cause of the failure; and
- (iii) reschedule, re-perform and report on results of the test in accordance with this **Clause 17.3 [Project Site Tests]**.

## **18. TIME FOR COMPLETION, RATE OF PROGRESS AND ACCELERATION**

### **18.1 Time for Completion**

The Contractor shall Complete the Works within the Time for Completion or such other time as may be determined in accordance with **Clause 19 [Extension of Time for Completion]**.

### **18.2 Rate of progress**

If for any reason, which does not entitle the Contractor to an extension of time, the rate of progress of the design and Execution of the Works is at any time, in the opinion of the NATIS Representative, too slow to achieve Completion within the Time for Completion, the NATIS Representative shall so notify the Contractor who shall thereupon take such steps as are necessary, subject to the consent of the NATIS Representative, to expedite progress so as to complete the Works within the relevant Time for Completion. The Contractor shall not



be entitled to any additional payment or compensation for taking such steps. If any steps, taken by the Contractor in meeting its obligations under this Clause 18.2 [Rate of progress], involve NATIS in additional supervision costs, such costs shall, after due consultation with the Contractor, be determined by the NATIS Representative and shall be recoverable from the Contractor by NATIS, and may be deducted by NATIS from any monies due or which may become due to the Contractor and the NATIS Representative shall notify the Contractor accordingly. Neither such notice given by NATIS pursuant to this Clause 18.2 [Rate of progress] nor NATIS failure to issue such notice shall relieve the Contractor from its obligations to achieve the quality and rate of progress required by the Contract.

### 18.3 Acceleration

18.3.1 Where the NATIS Representative considers that the Contractor by adopting measures (referred to in this Clause 18.3 [Acceleration] as "Acceleration Measures") would be able to complete the Works earlier than the expiry of the Time for Completion or would be able to extinguish or significantly reduce any extension of time to which it would otherwise be entitled pursuant to Clause 19 [Extensions to the Time for Completion], the NATIS Representative shall notify the Contractor in writing. The NATIS Representative may in writing also request the Contractor to provide, the estimates of:

- (i) the price of adopting the Acceleration Measures; and
- (ii) any saving in time which could be made by adoption of the Acceleration Measures; and
- (iii) details of any other terms and conditions sought by the Contractor in consideration of agreeing to adopt the Acceleration Measures
- (iv) which estimates, details, terms and conditions are jointly referred to in this Clause 18.3 [Acceleration] as the "Acceleration Proposals".

18.3.2 The Contractor shall deliver the Acceleration Proposals to the NATIS Representative within [14 (fourteen)] days of the NATIS Representative's request made under Clause 18.3.1 [Acceleration]. The Contractor shall use its best endeavours to prepare Acceleration Proposals which would enable the Works to be accelerated in the most economical manner practicable.

18.3.3 Within [14 (fourteen)] days of receipt of the Acceleration Proposals, NATIS shall notify the Contractor in writing that the Acceleration Proposals are agreed, not agreed or that the NATIS Representative wishes to discuss them with the Contractor. If the Acceleration Proposals are agreed to or are agreed following any discussion between the Parties and the NATIS Representative thereafter instructs the Contractor to implement the Acceleration Measures:

- (i) the Contractor will do so at the time agreed in the Acceleration Proposals; and





- (ii) the Contractor shall be paid in respect of such Acceleration Measures as the Parties have agreed.

18.3.4 If:

- (i) the Contractor shall not have submitted Acceleration Proposals as required under Clause 18.3.2 [Acceleration]; or
- (ii) the Acceleration Proposals are not agreed to under Clause 18.3.3 [Acceleration]; or
- (iii) the NATIS Representative and the Contractor cannot reach agreement in relation to the Acceleration Proposals within [14 (fourteen)] days of the NATIS Representative's notice to discuss under Clause 18.3.3 [Acceleration]

the NATIS Representative shall be entitled to instruct the Contractor to adopt the Acceleration Measures in any event, with such additions or amendments thereto as the NATIS Representative shall require. If so directed by the NATIS Representative, the Contractor shall without prejudice to its rights under Clause 32 [Dispute Resolution Procedure] proceed to implement the proposed Acceleration Measures in accordance with the NATIS Representative's instructions.

- 18.3.5 Subject to the terms of any agreement made between the NATIS Representative and the Contractor under Clause 18.3.3 [Acceleration] if by adopting the Acceleration Measures, the Contractor reduces, but does not extinguish, the delay to the Completion of the Works for which it would have been entitled to a greater extension of time under Clause 19 [Extension of Time for Completion] than that actually required because the Acceleration Measures were adopted, then the Contractor shall, in any event, be granted, subject to Clause 19 [Extension of Time for Completion], an extension of time for the residual delay.

- 18.3.6 In the event that the NATIS Representative issues an instruction pursuant to Clause 18.3.4 [Acceleration]:

- (i) the Contractor shall prepare and submit to the NATIS Representative all such information and documents relating to the implementation of the Acceleration Measures as the NATIS Representative may reasonably require in writing; and
- (ii) the NATIS Representative shall as soon as reasonably practicable determine any adjustment to the Time for Completion as it considers fair in all the circumstances and shall so notify the Contractor in writing; and
- (iii) the NATIS Representative shall determine the sums which shall be added to the Contract Price for performance of the Acceleration Measures instructed.





- 18.3.7 If the NATIS Representative and the Contractor cannot reach agreement under Clause 18.3.3 [Acceleration] and the NATIS Representative does not instruct the Contractor to adopt the Acceleration Measures, the Contractor shall have no claim for additional payment or compensation or an extension of time arising out of or in connection with the preparation of the Acceleration Proposals made or any failure to reach agreement pursuant to this Clause 18.3 [Acceleration].

## 19. EXTENSION OF TIME FOR COMPLETION

### 19.1 Contractor's notice of event likely to cause delay

The Contractor shall closely monitor the progress of the Works and shall give written notice to NATIS Representative, with a copy to NATIS:

- 19.1.1 as soon as it can foresee any incident, circumstance and/or event of any nature affecting or likely to affect the progress of the Works such that the Completion of the Works will be or is likely to be delayed; or
- 19.1.2 should it have been unable to foresee such a incident, circumstance and/or event, then as soon as it becomes aware of the commencement of the incident, circumstance and/or event which has affected or is likely to affect the progress of the Works such that Completion of the Works will be or is likely to be delayed.

### 19.2 Reasons for delay and extension of time

It shall be a condition precedent to any extension of time by NATIS under any provision of the Contract, that in respect of each and every incident, circumstance or event identified in the notice given in accordance with **Clause 19.1** [Contractor's notice of event likely to cause delay] the Contractor shall, as soon as possible after such notice but in any event not later than [30 (thirty)] days after such notice or such longer period as NATIS Representative may in its absolute discretion determine, notify NATIS Representative in writing of any factors and the relevant Contract provision which it considers may entitle it to claim an extension of time together with a statement, by reference to the Programme where appropriate, providing:

- 19.2.1 full and detailed particulars of the expected effects of the delay;
- 19.2.2 the reasons why the delay has occurred or is likely to have occurred;
- 19.2.3 an explanation of any measures that the Contractor has adopted or proposes to adopt to avoid or reduce or mitigate the consequences of the delay or impediment;





- 19.2.4 details of which of the Delay Events (if any) has caused the delay or impediment;
- 19.2.5 details of any adverse effect on the ability of the Contractor to meet Technical Specifications and Drawings and any other requirements under the Contract;
- 19.2.6 an estimate of the extent of the expected delay in Completion beyond the relevant Time for Completion and any anticipated additional costs if any, as allowed under the Contract, resulting from the delay.
- 19.2.7 details of the documents the Contractor proposes to prepare and maintain to support any claim for an extension of time which must include a critical path network and other documents as required by the NATIS Representative in order to demonstrate entitlement;
- 19.2.8 details as to the effect on the Programme;
- 19.2.9 details of the measures which it has discussed and agreed with its Subcontractors to facilitate the reprogramming of the performance of their services as a consequence of the delay;
- 19.2.10 further substantiation of any particulars and estimate aforesaid as the NATIS Representative may reasonably request;
- 19.2.11 reasons as to why in the Contractor's opinion, the Contractor is entitled to any extension of time or compensation payment pursuant to any Project Document by reason of any delay; and
- 19.2.12 confirmation that it is a notice pursuant to this **Clause 19.2** [Reasons for delay and extension of time].

### 19.3 Further particulars

- 19.3.1 The Contractor shall give such further written notices or supporting particulars for any claim or any other notices which are required by NATIS Representative as may be reasonably necessary or as NATIS Representative may reasonably require for keeping up to date the particulars, estimates and substantiation referred to in **Clause 19.2** [Reasons for delay and extension of time].
- 19.3.2 Without any admission of liability on the part of NATIS, NATIS Representative may, on receipt of a notice under **Clause 19.2** [Reasons for delay and extension of time] inspect such contemporary records of the Contractor and may monitor the record-keeping and/or instruct the Contractor to maintain further contemporary records. The Contractor shall permit





NATIS Representative to inspect all records and shall supply it with copies thereof as and when NATIS Representative instructs.

- 19.3.3 Where a circumstance has a continuing effect or where the Contractor is at any time unable to determine whether the effect of a circumstance will actually cause delay to the Completion of the Works, a statement to that effect with reasons and interim written particulars (including details of the likely consequences of the circumstance on the progress of the design and Execution of the Works and an estimate of the likelihood of and likely extent of the delay) must be submitted by the Contractor within [30 (thirty)] days of the notice given in accordance with **Clause 19.1** [Contractor's notice of event likely to cause delay]; the Contractor shall thereafter submit to NATIS Representative further interim written particulars at intervals of not more than [30 (thirty)] days until the actual delay caused (if any) is ascertainable, when it shall thereafter within [30 (thirty)] days submit to NATIS Representative full and detailed particulars of the cause and actual extent of the delay in accordance with **Clause 19.2** [Reasons for delay and extension of time].

#### 19.4 Delay Events

Subject to the other provisions of this **Clause 19** [Extension of Time for Completion], the Contractor will only be entitled to an extension of the Time for Completion where a delay to the achievement of Completion is caused by:

- 19.4.1 the Contractor not being given access to the Project Site or any part thereof in accordance with **Clause 4** [The Project Site]; or
- 19.4.2 a Change instructed under **Clause 23** [Changes] other than where such Change is instructed as a consequence of any default or breach of the Contract by the Contractor; or
- 19.4.3 any act, omission, default or breach by NATIS; or
- 19.4.4 any act, omission, default or breach by a Related Works Contractor; or
- 19.4.5 a Force Majeure Event.

#### 19.5 NATIS Representative to determine extension

Subject always to proper compliance by the Contractor with the provisions of this **Clause 19** [Extension of Time for Completion], NATIS Representative shall determine any extension of the Time for Completion and shall notify NATIS and the Contractor accordingly.





## 19.6 Compliance

19.6.1 It shall be a condition precedent to the Contractor's right to any extension of time that it shall have complied fully and strictly with any of the provisions of this **Clause 19 [Extension of Time for Completion]** in respect thereof. For the avoidance of doubt it is confirmed that this **Clause 19.6 [Compliance]** shall apply whether or not any other provision of the Contract is expressly stated to be subject to this **Clause 19 [Extension of Time for Completion]**.

19.6.2 Without prejudice to the generality of the foregoing:

- (i) the Contractor shall constantly use its reasonable endeavours to prevent and/or minimise delay in the progress of the Works, howsoever caused, and to prevent Completion of the Works being delayed or further delayed beyond the Time for Completion and the Contractor shall not be entitled to an extension of time in respect of any cause of delay nor for any period of delay which by the exercise of reasonable endeavours could be avoided or reduced (to the extent that such could have been reduced). The onus of proving that the Contractor has exercised all reasonable endeavours, and that despite such endeavours, the delay could not be avoided or reduced, shall in all cases rest with the Contractor;
- (ii) the Contractor shall not under any circumstances be entitled to an extension of time where the delay or likely delay is, or would be, attributable to the default, breach, negligence, improper conduct or lack of endeavour of the Contractor or any persons for whom it is contractually or otherwise responsible for and further the Contractor shall not be entitled to an extension of time where delay arises as a consequence of the termination of a Subcontractor's employment by the Contractor.
- (iii) if upon the request or claim by the Contractor for an extension of time for alleged delay to the progress of the Works, the NATIS Representative is of the opinion that such delay was caused or materially contributed to by any concurrent or interacting cause or causes of delay which are not Delay Events, then in considering or revising any extension of time in respect of that delay, the NATIS Representative may treat the said concurrent or interacting cause as the operative cause of the delay, provided always that to the extent that the delay caused by a Delay Event exceeds the period of delay which the NATIS Representative under this **Clause 19 [Extension of Time for Completion]** attributes to the operative cause of delay, the Contractor shall be entitled to an extension of time for that excess period;
- (iv) the Contractor shall have kept and maintained such records (including those referred to in the notices under this **Clause 19 [Extension of Time for Completion]**) as may be reasonably necessary to support any claim for an extension of time it may subsequently wish to make;





- (v) if there are two or more concurrent causes of delay and only one of those concurrent causes is a delay which would entitle the Contractor to an extension of time the Contractor is not entitled to an extension of time for the period of that concurrence;
- (vi) it is a further condition precedent to the Contractor's entitlement to an extension of time that the critical path noted on the Programme is affected in a manner which might reasonably be expected to result in a delay to the Contractor achieving Completion by the Time for Completion; and
- (vii) no relief shall be granted to an Affected Party to the extent that any failure or delay in its performance would nevertheless have been experienced by the Affected Party had an event of Force Majeure not occurred.

19.6.3 The Contractor shall after consultation with the NATIS Representative submit to the NATIS Representative within [7 (seven)] days of the consultation in accordance with **Clause 6.3** [Contractor's Documents] revisions to the Programme which the Contractor considers necessary to enable it to meet any extension of time fixed in accordance with this **Clause 19.5** [NATIS Representative to determine extension] and the requirements of the NATIS Representative.

19.6.4 The NATIS Representative shall not be obliged to take into account any circumstances which are not notified to it in accordance with the periods referred to in this **Clause 19** [Extension of Time for Completion] but may upon the written request of the Contractor extend the said periods if it considers the request for such extension reasonable.

## **19A. PROCEDURE FOR CLAIMS**

### **19A.1 Notice of claims**

If the Contractor considers that it may have grounds to claim any additional payment or any extension of time pursuant to any Clause of the Conditions or otherwise, it shall in addition to compliance with any other procedure or obligation in relation thereto, give notice to the NATIS Representative, with a copy to NATIS, within fourteen [14 (fourteen)] days after the event giving rise to the claim has first arisen. The notification shall include details of the clause under which the claim is made, the circumstances in which the claim arises and details of the records that the Contractor will maintain to substantiate the amount of its claim.

### **19A.2 Contemporary records**

Upon the happening of the event referred to in Clause 19A.1 [Notice of claims], the Contractor shall maintain such contemporary records (including those referred to in its notice under Clause 19A.1 [Notice of claims]) as may reasonably be necessary to support





any claim it may subsequently wish to make. Without any admission of liability on the part of NATIS, the NATIS Representative may, on receipt of a notice under Clause 19A.1 [Notice of claims], inspect such contemporary records and may instruct the Contractor to maintain any further contemporary records as are reasonable and may be material to the claim of which notice has been given. The Contractor shall permit the NATIS Representative to inspect all records maintained pursuant to this Clause 19A.2 [Contemporary records] and shall supply it with copies thereof as and when the NATIS Representative so instructs.

#### 19A.3 Substantiation of claims

Within [28 (twenty eight)] days, or such lesser time as may be reasonably required by the NATIS Representative, of giving notice under Clause 19A.1 [Notice of claims], the Contractor shall send to the NATIS Representative an account giving detailed particulars of the amount claimed and the grounds upon which the claim is based. Where the event giving rise to the claim has a continuing effect, such account shall be considered to be an interim account and the Contractor shall, at such intervals as the NATIS Representative may reasonably require, send further interim accounts detailing the aggregate amount of the claim and any further grounds upon which it is based. In cases where interim accounts are sent to the NATIS Representative, the Contractor shall send a final account within [28 (twenty-eight)] days of the end of the effects resulting from the event. The Contractor shall, if required by the NATIS Representative so to do, copy to NATIS all accounts sent to the NATIS Representative pursuant to this Clause 19A.3 [Substantiation of claims].

#### 19A.4 Monthly particulars

In addition to its obligations under Clause 19A.1 [Notice of claims], Clause 19A.2 [Contemporary records] and Clause 19A.3 [Substantiation of claims] hereof, the Contractor shall send to the NATIS Representative by the 7th (seventh) day of every month an account giving as full and detailed particulars as is possible, of all claims for any additional payment compensation or any extension of time (whether arising under the express provisions of this Contract or otherwise in relation to the performance of the Contractor's obligations thereunder) to which the Contractor may consider itself entitled, including all Change Orders issued by the NATIS Representative which it has Executed during the preceding month. In the event of the Contractor failing to comply with this Clause 19A.4 [Monthly particulars], NATIS shall not be bound to make any additional payment or grant any extension of time to the Contractor in respect of any such claim or claims and the Contractor shall conclusively be deemed to have waived such claim or claims.

#### 19A.5 Payment of claims

Subject to Clauses 19A.4 [Monthly particulars] and Clause 19A.6 [Failure to comply], the Contractor shall be entitled to have included in any Certificate of Payment issued by the NATIS Representative pursuant to Clause 38.3.1 [Certificates of Payment] such amount in respect of any Change Order or any admissible claim as the NATIS Representative may consider due to the Contractor provided that the Contractor shall have supplied sufficient particulars to enable the NATIS Representative to determine the amount due, if any, in respect of such Change Order or claim. If such particulars are insufficient to substantiate the





whole of the claim and subject to Clause 19A.6 [Failure to comply] the Contractor shall be entitled to payment in respect of such part of the claim as the particulars may substantiate to the satisfaction of the NATIS Representative.

## 20. LIQUIDATED DAMAGES

### 20.1 Liquidated Damages for delay

If the Contractor fails to Complete the Works in accordance with the Contract so that the Date of Completion of the Works has not occurred within the Time for Completion, then the Contractor shall pay or allow to NATIS Liquidated Damages for such default for every day which shall elapse between the Time for Completion and the date stated in the Completion Certificate as being the Date of Completion of the Works. Provided always that the aggregate liability of the Contractor for Liquidated Damages under this Clause 20.1 [Liquidated Damages for delay] shall not exceed the percentage of the Contract Sum as specified in Special Conditions of Contract.

### 20.2 Payment of Liquidated Damages

20.2.1 On or before the first Business Day of any month following the Time for Completion NATIS shall notify the Contractor in writing of the amount of Liquidated Damages that may have become due in the preceding month.

20.2.2 NATIS may:

- (i) deduct and retain the amount of any Liquidated Damages becoming due under **Clause 20.1** [Liquidated Damages for delay] from any sums due or which become due to the Contractor; or
- (ii) require the Contractor to pay such amount to NATIS within [28 (twenty-eight)] days after receipt of the notice pursuant to **Clause 20.2.1** [Payment of Liquidated Damages] notwithstanding any dispute between the Parties as to the amount due or the liability to make payment of the same.

20.2.3 The payment of Liquidated Damages does not in any way relieve the Contractor from any of its obligations to complete the Works or from any other obligations and liabilities of the Contractor under the Contract.

20.2.4 For the avoidance of doubt and without prejudice to any continuing obligations of the Contractor under the Contract or otherwise, the issue of any Completion Certificate does not relieve the Contractor in respect of Liquidated Damages which have accrued up to the date of such Completion Certificate, but which have not yet been paid by the Contractor.





### 20.3 Genuine Pre-estimate of Damages

The Parties recognise the expense and inconvenience likely to be incurred from any need to prove the loss and damage that will be suffered by NATIS in the event of a failure by the Contractor to achieve Completion of the Works by the relevant Time for Completion. The Parties acknowledge that the Liquidated Damages is a genuine pre-estimation of and reasonable compensation for the loss and damage that will be suffered by NATIS in the event of any such failure on the part of the Contractor.

### 20.4 Payment of Bonus

NATIS shall pay the bonus amount to the contractor, for each day of early completion of works, as specified in the special conditions of contract. The completion date shall be the date as specified in the special conditions of contract OR the date as approved and notified by the NATIS representative in consideration of extension of time granted to the contractor for the completion of works as covered in the contract.

## 21. COMPLETION OF WORKS

### 21.1 Completion of Works

21.1.1 The Date of Completion of the Works shall be the date upon which the following criteria have been satisfied or waived in writing by NATIS at its sole discretion:

- (i) the design and Execution of the Works, other than the performance of obligations to be performed during the Defects Rectification Period, has been completed in accordance with the Contract, save in respect of the Punch List Items;
- (ii) all outstanding work which NATIS Representative requires to be completed before issue of the Completion Certificate, has been satisfactorily completed;

### 21.2 Application for an issue of the Completion Certificate

21.2.1 The Contractor shall make a written application to NATIS Representative with a copy to NATIS for a Completion Certificate no later than [2 (two)] Business Days of the satisfaction of the conditions stated in **Clause 21.1** [Completion of the Works]. Such application shall be accompanied by an undertaking to finish any outstanding work in accordance with **Clause 21.2.2** [Application for and issue of the Completion Certificate]. The Works shall be deemed to be complete when the Completion Certificate is issued by the NATIS Representative in accordance with the provisions hereof.





21.2.2 NATIS Representative shall, within [7 (seven)] days after receiving the Contractor's application in accordance with **Clause 21.2.1** [Application for and issue of the Completion Certificate] either:

- (i) issue the Completion Certificate to the Contractor with a copy to NATIS and NATIS stating the date upon which the Works achieved Completion in accordance with **Clause 21.1** [Date of Completion of the Works] and specifying any outstanding work, if any, which the Contractor is required to complete and the period or periods within which such work is required to be completed, such work to include:
  - (a) the Punch List Items;
  - (b) any other outstanding work notified to the Contractor by NATIS Representative; or
- (ii) in the event that the conditions set out in **Clause 21.1** [Completion of the Works] have not been satisfied, NATIS Representative shall reject the application giving its reasons, specifying:
  - (a) the work required to be carried out by the Contractor to enable the Completion Certificate to be issued; and
  - (b) the period within which such work is required to be completed.

### 21.3 Completing Punch List Items and any other outstanding works

21.3.1 The Contractor shall provide in writing to NATIS Representative reasonable notice of its reasonable requirements with respect of access to and use of the Works for the carrying out of:

- (i) the outstanding Works including any Punch List Items specified in the Completion Certificate;
- (ii) any rectification, repair or replacement of any items in accordance **Clause 22.1** [Defects rectification by the Contractor].

21.3.2 NATIS shall use reasonable endeavours to secure such access from NATIS on behalf of the Contractor. When carrying out such work the Contractor shall comply with all reasonable instructions of NATIS with regard to the safety of the Works and the ongoing performance





by NATIS of its obligations and shall complete the work in such manner that, so far as reasonably practicable, does not prevent, hinder or otherwise interfere with the performance of NATIS of its obligations and the exercise of its rights during the Project Facility operations period.

21.3.3 The Contractor shall complete any Punch List Items specified in the Completion Certificate within the time instructed reasonably by NATIS Representative.

21.3.4 Within 60 (sixty) days of Date of Completion of the Works, the Contractor shall furnish to NATIS, three copies of "As built Documents" duly verified by the NATIS Representative, including without limitation an "as built" survey illustrating the layout of the Project Facility and the Works, and setback lines, if any, of the buildings and structures forming part of Project Facility and the Works reflecting the Project Facility as actually designed, engineered and constructed.

#### 21.4 Completion of parts

21.4.1 If in accordance with the requirements of the NATIS Representative, any part of the Permanent Works has been completed, the NATIS Representative may in its absolute discretion issue to the Contractor a Completion Certificate in respect of that part of the Permanent Works before Completion of the whole of the Works as aforesaid and upon the issue of such certificate the Contractor shall be deemed to have undertaken to complete any Punch List Items in that part of the Permanent Works during the Defects Rectification Period.

21.4.2 No completion certificate issued in accordance with **Clause 21.4.1** [Completion of parts] shall be deemed to certify completion of any ground or surface requiring reinstatement, unless such certificate shall expressly so state.

## 22. RECTIFICATION OF DEFECTS AND MAINTENANCE OF THE PERMANENT WORKS

### 22.1 Defects rectification by the Contractor

22.1.1 The NATIS Representative shall have the right, but not the obligation, to instruct the Contractor in writing to Execute all such work of repair, amendment, reconstruction, rectification and make good defects, imperfections or other faults in the Works and any part thereof, as the case may be, during the Defects Rectification Period or within [14 (fourteen)] days after its expiration as a result of an inspection made by or on behalf of the NATIS Representative at any time or times prior to its expiration. For the avoidance of doubt, the Contractor's obligations under this **Clause 22** [Rectification of defects and Maintenance of Permanent Works] apply to any damage to any Related Works caused by the Contractor.





- 22.1.2 All such work instructed under **Clause 22.1.1** [Defects rectification by the Contractor] shall be carried out by the Contractor at its own expense if the necessity thereof shall in the opinion of the NATIS Representative be due to the use of materials or workmanship not in accordance with the Contract or the neglect or failure on the part of the Contractor to comply with any of its obligations, expressed or implied, under the Contract.
- 22.1.3 The Contractor shall if required by the NATIS Representative in writing carry out such searches, or tests as may be necessary to determine the cause of any defect, imperfection or fault.
- 22.1.4 At all times during the Defects Rectification Period NATIS shall be fully entitled to Execute all work of repair, amendment, reconstruction, rectification and make good defects, imperfections or other faults in the Works and any part thereof, as the case may be, by its own workmen or by other contractors and if the necessity thereof shall in the opinion of the NATIS Representative be due to the use of materials or workmanship not in accordance with the Contract or the neglect or failure on the part of the Contractor to comply with any obligations, expressed or implied under the Contract, NATIS shall be entitled to recover from the Contractor the cost thereof or may deduct the same from any monies due or that become due to the Contractor.
- 22.1.5 If any defect, imperfection or other fault be such that, in the opinion of the NATIS Representative, it shall be impracticable or inconvenient to remedy the same, the NATIS Representative shall ascertain the diminution in the value of the relevant part of the Works due to the existence of such defects, imperfections or other faults and deduct the amount of such diminution from the sum remaining to be paid to the Contractor in respect of such parts of the Works, or failing such remainder it shall be recoverable as a debt due and payable to NATIS on demand.

## 22.2 Defects Rectification Certificate

The NATIS Representative shall issue to the Contractor (with a copy to NATIS) the Defects Rectification Certificate for the Works as soon after the expiration of the Defects Rectification Period as the Contractor shall, in the NATIS Representative's opinion, have completed all its obligations whether under **Clause 22** [Rectification of defects and maintenance of the Permanent Works] or otherwise, which relate to the Works or part thereof, as the case may be, including any work redesigned or amended, replaced and renewed, and shall state thereon the date when such obligations shall have in its opinion been so completed.

## 22.3 Continuing Obligations

Notwithstanding the issue of the Defects Rectification Certificate the Contractor shall remain liable for the fulfilment of any obligation incurred under the provisions of the Contract prior to the issue of the Defects Rectification Certificate which remains unperformed at the time such Defects Rectification Certificate is issued and, for the





purposes of determining the nature and extent of any such obligation, the Contract shall be deemed to remain in force between the Parties.

## 22.4 Endemic Failures

- 22.4.1 Notwithstanding any other provisions of the Contract (including this **Clause 22.4 [Endemic Failures]**) if, during the course of Execution of the Works or in the 7 (seven) year period immediately following the date of Completion of the Works NATIS forms the opinion that, because of the nature and frequency of the failures of any part of the Works caused as a consequence of a breach of the Contractor's obligations under the Contract, including, but not limited to, any component or sub-assembly thereof, such part can properly be said to have failed endemically it may so certify by notice in writing to the Contractor to that effect.
- 22.4.2 Should any part of the Works be certified under **Clause 22.4.1 [Endemic Failures]** to be the subject of an endemic failure then the Contractor shall as soon as reasonably practicable renew or alter or replace (including as necessary redesigning) all such or parts throughout the Works whether or not such part had experienced failure, so as to avoid any subsequent defect therein. The cost of such renewal, repair, alteration or replacement (including any redesign) shall be borne by the Contractor together with the cost of any work ancillary thereto. Before commencing any renewal, alteration or replacement the Contractor shall submit to NATIS for its review, the Contractor's proposals for such renewal, alteration or replacement.
- 22.4.3 The renewals, repairs, alterations or replacements (including redesign) shall be carried out and completed to the reasonable satisfaction of NATIS and so that the Works will meet the Contractor's obligations under the Contract. The provisions of this **Clause 22.4 [Endemic Failures]** shall apply to all such renewals, repairs, alterations and replacements as though the part of the Works in question, together with any other part of the Works affected thereby had been the subject of a Completion Certificate on the date the renewal, repair, alteration or replacement was completed.
- 22.4.4 Any renewals, repairs, alterations or replacements under **Clause 22.4 [Endemic Failures]** shall be without prejudice to the Contractor's other obligations under the Contract including without limiting the generality thereof this **Clause 22.4 [Endemic Failures]**. Nothing contained in this **Clause 22.4 [Endemic Failures]** shall prejudice any other rights or remedies NATIS may have.
- 22.4.5 If the Contractor disagrees with NATIS notification of evidence or failure under **Clause 22.4 [Endemic Failures]**, the Contractor shall nevertheless proceed to effect the renewal, repair, alteration or replacement required and the Contractor's rights in respect thereof shall be determined in accordance with **Clause 32 [Dispute Resolution Procedure]**.





## 22.5 Liability for Latent Defects

- 22.5.1 The Contractor shall be liable for the costs of rectification of any Latent Defect in and/or damage caused to the Works as a result of such Latent Defect which is notified to the Contractor and which may appear or occur during the Latent Defects Rectification Period.
- 22.5.2 If any such Latent Defect in and/or such damage to the Works shall appear or occur, the NATIS Representative shall notify the Contractor immediately stating the nature of the Latent Defect and/or damage. In the event that such Latent Defect is a defect which does not affect the proper operation and maintenance of the Project Facility NATIS may, in its sole discretion, allow the Contractor a reasonable period of time in which to rectify the Latent Defect. If the Contractor fails to rectify any such Latent Defect and/or such damage within the period notified by the NATIS Representative NATIS may, at the Contractor's risk and expense, rectify the Latent Defect and/or such damage or may employ another contractor to carry out such rectification.
- 22.5.3 In the event that such Latent Defect is adversely affecting the operation and maintenance of the Project Facility NATIS may, in its sole discretion employ and pay another contractor to carry out such rectification and recover the cost of such rectification from the Contractor.

## 22.6 Maintenance Obligations

- 22.6.1 The Contractor shall take full responsibility for the maintenance and upholding of the Permanent Works and the site offices (if any) used by the Contractor during the Defects Rectification Period.
- 22.6.2 The Contractor shall ensure that its maintenance obligations are performed in such a manner as will permit the proper performance by NATIS in its operation of the Project Facility and so as not to affect the activities of the Project Facility users.
- 22.6.3 In the event the Contractor has failed to maintain and uphold the Permanent Works during the Defects Rectification Period in accordance with the relevant provisions of the Technical Specifications and Drawings and such failure has not been remedied within [14 (fourteen)] days despite a written notice to that effect issued by the NATIS Representative, NATIS may, without prejudice to any of its rights and/or remedies under the Contract, be entitled to cause the maintenance and upholding of the Permanent Works to be undertaken by others at the risk and cost of the Contractor and NATIS shall be entitled to recover from the Contractor the cost thereof or may deduct the same from any monies due or that become due to the Contractor.



## 23. CHANGES



### 23.1 General

23.1.1 The Contractor shall not carry out any Change except as directed by NATIS Representative and in accordance with this **Clause 23 [Change]**.

23.1.2 The Contractor acknowledges and accepts that no Change shall in any way vitiate or invalidate the Contract.

23.1.3 Subject to the terms of this **Clause 23 [Change]**, the Contractor will be required to perform any Change howsoever initiated.

### 23.2 Procedure for Changes

23.2.1 NATIS Representative has the right to initiate a Change at any time by either:

- (i) instructing in writing a Change Order in which case the Contractor shall comply with **Clause 23.2.3 [Procedure for Changes]**; or
- (ii) issuing a written notice proposing a Change (a "Change Notice").

23.2.2 Within [14 (fourteen)] days of receipt of a Change Notice, the Contractor shall provide to NATIS Representative a written statement setting out detailed particulars of any effect the proposed Change would have on the Works and Related Works and/or on any other provisions of this Contract if the proposed Change is effected (a "Change Notice Response") including:

- (i) the work and/or Goods required or no longer required as a consequence of the Change;
- (ii) an estimate of the increase or decrease in the Contract Price (which will include any extra costs necessarily incurred (if any) by the Contractor for delay or disruption as a consequence of a Change OR any change in the contract price, resulting out of variation of agreed quantities);
- (iii) any effect on the availability and/or cost of insurance;
- (iv) any effect on the Programme, the Payment Schedule and the Time for Completion;





- (v) any proposed modifications to the Contract;
- (vi) whether on account of the Change any Applicable Clearances will not be obtainable without onerous conditions or within a reasonable period or any existing Applicable Clearances will be revoked or adversely affected;
- (vii) whether the Change would, if implemented, give rise to a breach of any Applicable Law or be contrary to Good Industry Practice;
- (viii) whether the Change is technically feasible on reasonable commercial terms;
- (ix) where **Clause 23.3.1(ii) [Contractor Changes]** applies, a calculation of the benefit the Contractor believes NATIS will obtain, expressed in financial terms; and
- (x) any other information which NATIS may reasonably request.

23.2.3 Following receipt of a Change Order, the Contractor must immediately implement the Change subject to the following terms:

- (i) the Contract Sum will be amended in accordance with the principles to be mutually agreed between NATIS and the Contractor;
- (ii) any extension of time will be determined in accordance with **Clause 19 [Extension of Time for Completion]** and NATIS Representative is entitled to take account of the Contractor's estimate (if any) set out in **Clause 23.2.2 [Procedure for Changes]** when determining such extension of time;
- (iii) these Conditions (as amended from time to time) will apply to the Change as though it formed part of the Works.

23.2.4 Following receipt of a Contractor's Change Notice Response, NATIS Representative may either:

- (i) issue a written Change Order to the Contractor, on such terms and conditions as NATIS Representative may deem appropriate and the Contractor shall implement the Change in accordance with **Clause 23.2.3 [Procedure for Changes]**; or
- (ii) withdraw the Change Notice.





The Contractor shall not be entitled to any costs or extension of time as a result of preparing a Change Notice Response.

23.2.5 If:

- (i) the Contractor fails to comply with its obligation under Clause 23.2 [Procedure for Changes]; or
- (ii) if the NATIS Representative rejects the information provided by the Contractor pursuant to Clause 23.2 [Procedure for Changes] (which the NATIS Representative is entitled to do in its absolute discretion);

NATIS shall be entitled, following notification to the Contractor, to engage a third party to perform the Change, in which case the Contractor shall cooperate fully with any such third party or the NATIS Representative may nevertheless instruct a Change Order which the Contractor shall comply with and Clause 23.2 [Procedure for Changes] shall apply.

23.2.6 Notwithstanding the provisions of Clause 23.2.2 [Procedure for Changes] and Clause 23.2.5 [Procedure for Changes] the NATIS Representative may instruct a Change Order at any time, whether before or after receipt of the Contractor's estimate under Clause 23.2 [Procedure for Changes] which the Contractor shall comply with and Clause 23.2 [Procedure for Changes] shall apply.

### 23.3 Contractor's Changes

23.3.1 The Contractor may from time to time during its performance of the Contract propose to NATIS Representative any Change which the Contractor considers:

- (i) necessary for the proper design and Execution of the Works; or
- (ii) which adopted will:
  - (a) substantially reduce the cost of Executing, maintaining and operating the Works or the Project; or
  - (b) improve the efficiency or value to NATIS of the Completed Works (including a reduction in the life cycle costs associated with the Project); or





- (c) otherwise be of benefit financial or otherwise, to NATIS

and such proposal must be in writing and shall be in the form of and contain such information as required of a Change Notice Response referred to in **Clause 23.2.2** [Procedure for Changes].

23.3.2 Where **Clause 23.3.1(i)** [Contractor's Changes] applies NATIS Representative may either:

- (i) issue a written Change Order to the Contractor and the Contractor shall implement the Change in accordance with **Clause 23.2.2** [Procedure for Changes]; or
- (ii) reject the Change proposed by the Contractor.

The Contractor shall not be entitled to any costs or extension of time as a result of preparing a proposal in accordance with **Clause 23.3.1** [Contractor's Changes].

23.3.3 Where **Clause 23.3.1 (ii)** [Contractor's Changes] applies NATIS Representative may, at its sole discretion, accept or reject the Contractor's proposed Change and failure by NATIS Representative to respond within [14 (fourteen)] days shall be deemed to be a rejection. If NATIS wishes to implement a Change suggested by the Contractor, NATIS shall be liable to pay the Contractor a proportion identified in Special Conditions of Contract.

#### 23.4 Omissions

23.4.1 The Contractor acknowledges that a Change may involve the omission of any part or parts of the Works up to 20% (twenty percent) of the total Contract Price and the Contractor acknowledges and agrees that NATIS may engage others to carry out that part or parts so omitted.

23.4.2 In case of an omission of any part or parts of the Works being due to any reason other than a failure of the Contractor to comply with the obligations under the Contract, NATIS and the Contractor shall mutually agree the reasonable compensation payable to the Contractor on account of loss of profit and overheads arising from the omission of any part or parts of the Works, provided that such compensation agreed shall not exceed 10% (ten percent) of the part or parts of the Works omitted. The value of the part or parts of the Works omitted shall be determined in accordance with **Clause 23.5.1** [Valuation of Changes].

23.4.3 The Contractor further acknowledges that any one or more omissions will not constitute a basis to allege that NATIS has repudiated the Contract, no matter the extent or timing of such omission.





## 23.5 Valuation of Changes

23.5.1 The valuation of a Change to be paid by NATIS to the Contractor, or by the Contractor to NATIS, as the case may be, shall be calculated as follows:

- (i) the Parties will endeavour to agree to the valuation; and
- (ii) failing an agreement under **Clause 23.5.1(i)** [Valuation of Changes] within a reasonable time (but no more than [28 (twenty-eight)] days after the NATIS Representative's direction in accordance with **Clause 23.2.4(i)** [Procedure for Changes], NATIS will determine the valuation, subject to the following:
  - (a) in the event that the Change involves additional works, the increase to the Contract Price will be no more than the estimate (if any) provided in accordance with **Clause 23.2.2** [Procedure for Changes]; and
  - (b) in the event that the Change involves the omission of part of the Works or results in a saving to the Contractor, the reduction in the Contract Price will be no less than the estimate (if any) provided in accordance with **Clause 23.2.2** [Procedure for Changes];

the following valuation principles shall apply:

1. where the varied work is similar in character to and Executed under similar conditions to work priced in the Price Breakdown, such work shall be valued at the applicable rates and prices in the Special Conditions of Contract;
2. where the varied work is not of a similar character to or not Executed under similar conditions to work priced in the price breakdown then the NATIS Representative shall establish a new rate for such work based upon the rates or prices contained in the Special Conditions of Contract insofar as may be reasonable making such allowances thereto by way of additional or deductions as may be necessary to take account of any dissimilarity in the character of the work or the conditions under which the work was Executed;
3. where work is omitted, the rates and prices in the Special Conditions of Contract shall be used to value the work omitted provided that if part only of an item of work is omitted then NATIS Representative shall establish a new rate or price by which to value the omitted work which shall be fair and reasonable.





4. where the varied work cannot be properly valued in accordance with the provisions of **Clauses 23.5.1(ii) (1), (2) or 3** [Valuation of Changes] above, the NATIS Representative shall establish a new rate or price for such work which shall be fair and reasonable.

23.5.2 The Contractor shall maintain all proper records relating to any Change Order instructed and in addition the NATIS Representative shall be entitled within [14 (fourteen)] days after issuing a Change Order to instruct the Contractor as to any records that the NATIS Representative requires it to keep. The Contractor shall keep such records at its own expense and submit them to the NATIS Representative as directed.

23.5.3 Without prejudice to **Clause 23.2** [Procedure for Changes] the NATIS Representative may, in its absolute discretion, instruct a Change Order in circumstances where, in its absolute discretion, the Contractor will fail to meet any of its obligations under the Contract or where it is necessary on account of some default or breach of the Contract by the Contractor or those for whom it is responsible for, in which case the Contractor shall not be entitled to any extension of time or any increase in the Contract Sum, and any adjustment to the Time for Completion.

#### 23.6 Day works

23.6.1 NATIS Representative may if, in its opinion, it is necessary or desirable order in writing that any additional or substituted work including any Provisional Sum Works shall be executed on a daywork basis. The Contractor shall then be paid for such work in accordance with the Daywork Schedule. No variation of any daywork unit rate or price shall be considered for items in the Daywork Schedule, notwithstanding the quantity of work performed under such schedule. The Contractor shall furnish to NATIS Representative such receipt or other records as may be necessary to prove the amounts paid and before ordering materials shall submit to NATIS Representative quotations for the same for its approval.

23.6.2 In respect of all work executed on a daywork basis the Contractor shall during the continuance of such work deliver each day to the NATIS Representative an exact list in duplicate of the names, occupation and time of all workmen employed on such work and a statement also in duplicate showing the description and quantity of all Materials and equipment used thereon or therefore. One copy of each list and statement will if correct or when agreed be signed by the NATIS Representative and returned to the Contractor. At the end of each month the Contractor shall deliver to the NATIS Representative a priced statement of the labour and material (except as aforesaid) used and the Contractor shall not be entitled to any payment unless such lists and statements have been fully and punctually rendered. Provided always that if the NATIS Representative shall consider that for any reason the sending of such list or statement by the Contractor in accordance with the foregoing was impracticable it shall nevertheless be entitled to authorise payment for such work either as daywork (on being satisfied as to the time employed and Materials and equipment used on such work) or at such value therefore as it shall consider fair and reasonable.





## 24. INTELLECTUAL PROPERTY

### 24.1 Intellectual Property

24.1.1 All Intellectual Property which is proprietary to NATIS or the Contractor shall be the exclusive property of NATIS or the Contractor respectively, as the case maybe.

24.1.2 It is agreed between the Parties that, subsequent to the date hereof, all and any Intellectual Property developed by the Contractor and/or NATIS either jointly or severally in connection with the performance, execution and implementation of the Works, shall at all times be and remain the sole and exclusive property of NATIS. The Parties however agree that if the Contractor wishes to use for development of facilities owned by the Contractor/in house such Intellectual Property (i.e. that having been jointly or severally developed by the Contractor and/or NATIS) for a period until the expiry of five (5) years from the date of this Contract, then in such an event the Contractor shall be entitled to use the said Intellectual Property without any cost/charge for use thereof.

However, where (i) the Contractor intends to use the said Intellectual Property subsequent to the expiry of the period of five (5) years from the date of this Contract; or (ii) the Contractor intends to use the said Intellectual Property right for any third party at any time, then in such event, the Contractor shall be entitled to use the said Intellectual Property right with the prior written approval of NATIS and on such commercial terms as may be mutually agreed to between the Parties.

### 24.2 Unique Copyright

24.2.1 The Contractor hereby grants to NATIS an option exercisable by notice from NATIS to the Contractor at any time and as often as required to take an assignment from the Contractor with full title guarantee of all Intellectual Property in any Contractor's Documents (and all modifications and amendments to such Contractor's Documents), whether existing at the date of the Notice to Proceed or coming, into existence in future and wherever in the world arising, relating to any aspect of the Contractor's design which in NATIS's reasonable opinion is original or unique to or individually characteristic of the Project ("Unique Copyright") and no further fees shall be payable by NATIS in respect of such assignment.

24.2.2 To the extent that NATIS becomes beneficial owner of any Unique Copyright pursuant to this **Clause 24.2** [Unique Copyright] NATIS hereby grants to the Contractor an irrevocable, royalty-free, non-exclusive licence to use and to reproduce such Unique Copyright for the purpose of performing the Contract Obligations. Such licence is granted on the basis that such Unique Copyright shall not be used except for the purpose specified in this **Clause**.

### 24.3 Infringing Matter





24.3.1 The Contractor warrants and represents that:

- (i) it has all rights and licences necessary to grant, assign and transfer to NATIS licences and assignments in accordance with this **Clause 24.1.2** [Intellectual Property]; and
- (ii) there is and will be no infringement of any Intellectual Property, in respect of the rights licensed and transferred to NATIS pursuant to **Clause 24.1.2** [Intellectual Property] or assigned otherwise used in connection with the Works.

24.3.2 The Contractor shall indemnify and hold harmless NATIS against all issues, claims, damages, liabilities, costs and expenses (including legal costs) incurred by it in respect of any breach of the warranty in **Clause 24.3.1** [Infringing Matter]. The Contractor shall ensure that in any appointment and/or Subcontract with any Subcontractor, the Contractor obtains the right to licence, assign and transfer in accordance with **Clause 24.1.2** [Intellectual Property] the Intellectual Property in all or any Contractor's Documents and that such Subcontractor will enter into and execute such documents in favour of NATIS and/or the Contractor and/or its Subcontractors to effect a valid licence and/or assignment of such Intellectual Property.

24.3.3 If either NATIS or the Contractor is prevented from operating or using the Works or any Intellectual Property or any part thereof ("Infringing Matter"), the Contractor must at its own expense, in addition to its other obligations under the Contract, take all steps necessary to procure for NATIS the right to operate or use the Infringing Matter for its intended purpose.

24.3.4 If the Contractor is unable to procure those rights referred to in **Clause 24.3.3** [Infringing Matter] within such time as NATIS directs, the Contractor must promptly, and at its own expense, comply with any direction by NATIS to do one or more of the following:

- (i) modify the Infringing Matter (but not so as to adversely affect its functionality or fitness for the purpose for which it is intended);
- (ii) replace the affected part of the Infringing Matter, so as to overcome the infringement;
- (iii) remove the affected part of the Infringing Matter and compensate NATIS for any cost, loss, expense or damage incurred by NATIS;
- (iv) acquire a licence for NATIS to use such Intellectual Property;





and any such direction is not a Change Order nor does it entitle the Contractor to any extension of time or any additional payment.

- 24.3.5 The Contractor represents and warrants that except for amounts included in the original Contract Sum, no royalties or other payments are due or payable by NATIS to the Contractor or any other person in respect of any Intellectual Property or the use of or the grant of a right to use any Intellectual Property.
- 24.3.6 NATIS shall be entitled to assign or transfer the licence of the Intellectual Property granted by the Contractor in accordance with **Clause 24.1.2 [Intellectual Property]** to any person or persons engaged in connection with the design operation and/or maintenance of the Works.
- 24.3.7 The Contractor's obligations under this **Clause 24.1.2 [Intellectual Property]** will not cease on the completion, expiry or termination of the Contract or any other discharge of the Contract.
- 24.3.8 As between the Parties, NATIS shall retain the copyright and other Intellectual Property in the Technical Conditions of the Contract and other documents provided or made by (or on behalf of) NATIS.

## 25. INSURANCES

### 25.1 Project Facility Insurances

NATIS shall at its cost and expense, purchase and maintain in force (or procure that they are taken out and maintained in force) with reputable insurers, the Project Facility Insurances.

### 25.2 Contractor Insurances

The Contractor shall at its cost and expense, purchase and maintain in force (or procure that they are taken out and maintained in force) with reputable insurers, the Contractor's Insurance.

As a minimum, the Contractor shall maintain the following Insurances:

- (a) Insurance for Works, Plant and Materials: for the full reinstatement cost including the cost of demolition, removal of debris and professional fees and profit until the date of issue of Defect Rectification Certificate;
- (b) Insurance for Contractor's Equipment: for not less than the full replacement value, including delivery to Site until the date of issue of Completion Certificate.





- (c) Insurance against Injury to Persons and Damage to Property: for any loss, damage, death or bodily injury which may occur to any physical property (except things insured under (a) & (b) above) or to any person (except persons insured under (d) below), which may arise out of the Contractor's performance of the Contract and occurring before the date of issue of Defect Rectification Certificate.
- (d) Insurance for Contractor's Personnel: against liability for claims, damages, losses and expenses (including legal fees and expenses) arising from injury, sickness, disease or death of any person employed by the Contractor or any other of the Contractor's Personnel for the whole duration these Personnel are assisting in execution of the Works. For a Subcontractor's employees, the insurance may be effected by the Subcontractor, but the Contractor shall be responsible for compliance with this Clause.

### 25.3 Required Insurances

The terms of the Required Insurances shall entitle NATIS to maintain the policies in force after termination of the Contractor's employment under the Contract.

### 25.4 Evidence

Either Party, at the request of the other shall, from time to time, provide to the other Party copies of all insurance policies (or appropriate endorsements, certifications or other satisfactory evidence of insurance) obtained in accordance with the Contract (including the provision of copies of renewal confirmations as soon as possible).

### 25.5 Compliance

- 25.5.1 The Contractor shall from time to time promptly pay any insurance premium due, keep the insurance policies in force and valid and furnish copies thereof to NATIS in accordance with this **Clause 25 [Insurances]**. Within [10 (ten)] days of receiving any insurance policy certificates in respect of the Insurances, the Contractor shall furnish to NATIS, copies of such policy certificates, copies of the insurance and evidence that the insurance premiums have been paid in respect of such Insurances.
- 25.5.2 The Contractor shall not cancel, modify or allow to expire or lapse any Contractor Insurances until the expiration of at least [60 (sixty)] days notice of such cancellation, modification or non-renewal has been provided by the Contractor to NATIS.
- 25.5.3 If at any time the Contractor fails to obtain or maintain in full force and effect any and all of the Contractor Insurances required under this Contract, NATIS may at its option obtain and maintain such insurance and all sums incurred by NATIS therefore shall be reimbursed by the Contractor to NATIS within [5 (five)] days from the receipt of claim in respect thereof made by NATIS.





## 25.6 Premiums

25.6.1 NATIS will bear the cost of all insurance premiums in relation the Project Facility Insurances, and the Contractor will bear the cost of all insurance premiums in relation to the Contractor's Insurances.

## 25.7 Deductibles and application of insurance proceeds

25.7.1 The Contractor shall be responsible for the amount of any deductibles under the Required Insurances to the extent to which the claim results from an act, omission or default on the part of the Contractor or from circumstances for which the Contractor indemnifies NATIS under the Contract. Regardless of the loss, any deductions in excess of the deductibles prescribed under the Contractors Insurances, or any amounts not recovered from the Insurer by the Contractor, notwithstanding compliance by the Contractor under **Clause 25.5** [Compliance] shall be borne by the Contractor.

25.7.2 The proceeds of all insurance policies received shall be promptly applied by the Contractor towards repair, renovation, restoration or re-instatement of the Works or any part thereof which may have been damaged or destroyed.

25.7.2 The Contractor shall carry out such repair, renovation, restoration or re-instatement to the extent possible in such manner that the Works after such repair, renovation, restoration or re-instatement be as far as possible in the same condition as it were prior to such damage or destruction, normal wear and tear excepted.

## 26. PAYMENT

### 26.1 Payment Schedule

The Payment Schedule includes a schedule setting out each Milestone Event to be achieved in a month for the Works.

### 26.2 Contractor's Application for Payment

26.2.1 From the date of issue of the Notice to Proceed, on the 5th (fifth) Business Day of any month, the Contractor may submit a Request for Payment, to NATIS Representative in respect of the preceding month.

26.2.2 Within each Request for Payment the Contractor shall show separately:





- (i) the amounts which the Contractor claims to be payable as the cost of the Works completed during that month; and
- (ii) the cumulative amount of all prior payments made by NATIS; and
- (iii) any amounts to which the Contractor considers are due and payable to it in accordance with the provisions of the Contract.

26.2.3 The Contractor's Request for Payment shall:

- (i) be prepared on forms in the form and in a number advised by NATIS Representative; and
- (ii) contain confirmation of the relevant Milestone Events which, in the opinion of the Contractor have been achieved in that month which applies to each such Milestone Event; and
- (iii) be accompanied by:
  - (a) Copy of relevant records of measurement of works, jointly taken and signed by both the parties;
  - (b) a status report describing in such detail as may reasonably request, the percentage of any uncompleted Milestone Event for the month in question and the work to be undertaken by the Contractor prior to the next Request for Payment;
  - (b) certification by NATIS Representative confirming that the Milestone Events referred to in the Request for Payment have been achieved.
  - (c) confirmation by the Contractor of any amounts due and owing from the Contractor to NATIS pursuant to the Contract;
  - (d) the Contractor's certification that the quality of all completed Works accords with the requirements of the Contract;
  - (e) the Contractor's certification that each obligation, item of cost or expense mentioned in that Request for Payment has not been the basis of any previous payment.
  - (f) the Contractor's certification that it has reviewed all financial and budget data contained in the Request for Payment;





- (g) the Contractor's certification that the quality of all completed Works accords with the requirements of the Contract;
- (h) the Contractor's certification that each obligation, item of cost or expense mentioned in that Request for Payment has not been the basis of any previous payment; and
- (i) the Contractor's certification that each Subcontractor who performed part of the Works which was included in the immediately preceding Certificates of Payment was paid all amounts then due to it for such Works
- (j) The Contractor providing evidence of the validity of the Contractor's Insurances.

### 26.3 Certificates of Payment

- 26.3.1 Within [14 (fourteen)] Business Days of receipt of the Contractor's Request for Payment under **Clause 26.2** [Contractor's Application for Payment], NATIS and NATIS Representative shall review such request and, shall issue to the Contractor, a Certificate of Payment certifying what amounts NATIS shall pay. Each Certificate of Payment shall be for an amount which in the opinion of NATIS, is the basis of the Request for Payment and pursuant to the Contract, is properly due to the Contractor (the "Gross Certifiable Amount") less (i) the cumulative amounts of payments previously certified as due to the Contractor, (ii) any deduction on account of recovery of Advance Payment, and (iii) Retention Amount.
- 26.3.2 In the event that the Contractor fails to achieve any Milestone Event specified in the Payment Schedule, the Contractor shall not be entitled to the payment value attributable to that Milestone Event until the relevant Milestone Event has been achieved. When the relevant Milestone Event is achieved, the Contractor may include the payment value attributable to the Milestone Event in the next Request for Payment.
- 26.3.3 No sum shall be included in the Certificate of Payment in respect of Materials yet to be incorporated into the Permanent Works unless the NATIS Representative is satisfied that:
  - (i) such Materials have been properly acquired and properly and not prematurely delivered to the Project Site;
  - (ii) such Materials have been properly stored on the Project Site and fully protected against loss, damage or deterioration;





- (iii) the Contractor's records of the requisitions, orders, receipts and use of any Materials are kept in a form approved by the NATIS Representative, and such records are available for inspection by the NATIS Representative; and
- (iv) the Contractor has submitted a proper statement of the cost of acquiring the Materials together with such documents as may be required for evidencing such cost.

26.3.4 Without prejudice to any other rights of NATIS to withhold payment to the Contractor, NATIS may withhold from any payment due to the Contractor such amount as NATIS deems reasonably necessary or appropriate:

- (i) if in the opinion of the NATIS Representative the progress of the Works at the time of the Request for Payment is behind the progress of the Works as set out in the Programme; and/or
- (ii) to protect it from any losses, expenses, costs or liability because of any one or more of the following reasons:
  - (a) defects and deficiencies in any Works, whether or not payment has been made;
  - (b) unsatisfactory performance of the Contract;
  - (c) the filing of third party claims relating to the Works or any of its commitment parts for which the Contractor is liable;
  - (d) the Contractor's failure to make payments to Subcontractors;
  - (e) failure by the Contractor to provide or procure replacement Performance Security in accordance with the Contract;
  - (f) failure by the Contract to provide evidence of insurance coverage in accordance with the Contract;
  - (g) reasonable evidence that Completion will not occur by the Time for Completion;





- (h) any overpayments made by NATIS with respect to a previous payment;
- and
- (i) failure by the Contractor to submit a properly updated monthly Programme;
- (j) failure by the Contractor to provide satisfactory evidence that the costs of all labour and Materials and other obligations arising out of the Contract have been fully satisfied and discharged by the Contractor and/or to otherwise fail to submit adequate supporting documentation for any Request for Payment.

26.3.5 Any Provisional Sum Works shall only be executed in whole or part upon the NATIS Representative's instruction. If the NATIS Representative issues no such instruction, the Provisional Sum Works shall not form part of the Works and the Contractor shall not be entitled to payment for it. The Contractor shall be deemed to have allowed the necessary time and resources to enable design and Execution of the Provisional Sum Works in so far as the scope and nature of the Provisional Sum Works was reasonably foreseeable.

26.3.6 The Contractor shall be entitled only to such amount in respect of the Provisional Sum Works as the NATIS Representative determines in accordance with this Clause 26.3.6. The NATIS Representative shall notify the Contractor of any such determination. The NATIS Representative shall have the authority to issue instructions to the Contractor for every Provisional Sum Works for which the Contractor shall be entitled to a part of the Provisional Sum as determined by the NATIS Representative.

26.3.7 The Contractor shall produce to the NATIS Representative all quotations, vouchers, invoices, accounts or receipts in connection with the expenditure in respect of the Provisional Sum Works, except where the Provisional Sum Works is valued in accordance with the item wise rates quoted by the Contractor in its bid submitted to the Employer.

26.3.8 In respect of every Provisional Sum the NATIS Representative shall have authority to issue instructions for the execution of work or for the supply of goods, materials, Plant Sums or services by the Contractor, in which case the Contractor shall be entitled to an amount equal to the value thereof determined in accordance with Clause 23.

#### 26.4 Payment

NATIS shall pay the amount certified in a Certificate of Payment less the amount paid earlier in accordance with **Clause 26.3.1** [Certificate of Payment], no later than [15 (fifteen)] Business Days from the date of such Certificate of Payment.

#### 26.5 Final Payment





26.5.1 Within [14 (fourteen)] Business Days after receipt of the Defects Rectification Certificate, the Contractor must submit a final payment claim entitled "Final Request for Payment", which must include:

- (i) statements for the Contract Sum, summarising and reconciling all previous payments made by NATIS and adjustments in the Contract Sum;
- (ii) such other amounts as the Contractor considers to be due from NATIS under the Contract.

26.5.2 Within [28 (twenty eight)] days of the receipt of the Contractor's Final Request for Payment, NATIS Representative shall review the statements for the Contract Sum, submitted in accordance with **Clause 26.5.1 [Final Payment]** and issue to the Contractor a Final Certificate of Payment certifying the payment which NATIS proposes to make which in the opinion of NATIS, on the basis of the Final Request for Payment and the Contract, is due to the Contractor less any amount which NATIS is entitled to withhold, return or set off pursuant to the Contract (the "Final Payment").

## 26.6 Disbursal of Final Payment

The Final Payment shall be paid to the Contractor within [45 (forty five)] Business Days of the notice of the Final Payment.

If the Contractor owes amounts to NATIS under the Contract which are greater than the Final Payment, then such excess is a debt due and payable on demand and may be deducted from any payments otherwise due from NATIS to the Contractor and NATIS may also have recourse to the Performance Guarantee and/or retention provided under the Contract.

## 26.7 Mode of Payment

All payments under the Contract shall be made in accordance with the method stipulated in Special Conditions of Contract.

## 26.8 Corrections to Certificates of Payment

NATIS Representative may in any Certificate of Payment make any correction or modification that should properly be made in respect of any previous Certificate.





## 26.9 Currency of Payment

The Contract Price and all payments to be made to the Contractor in respect thereof shall be in the currency set out at Special Conditions of Contract.

## 26.10 NATIS right to set off

NATIS shall, notwithstanding any provision to the contrary included in the Contract, be entitled to deduct from and set off against any amount due to the Contractor under the Contract, any amount or amounts which the Contractor is liable to pay to NATIS under the Contract.

## 26.11 Advance Payment for Mobilisation of works.

26.11.1 The advance payment to the contractor for mobilisation of works shall be limited to the percentage (%), as given in the special conditions of contract. Such advance payment shall also carry an interest as mentioned in the special conditions of contract. The Contractor shall, together with each Request for Payment containing an application for the Advance Payment, provide to NATIS an Advance Payment Guarantee from a Scheduled bank in India to which NATIS has given its prior approval in writing and in a sum equal to the Advance Payment, in the form appearing in Schedule D [Form of Guarantees]. NATIS shall pay the Advance Payment within [7(seven)] days of the receipt of the Advance Payment Guarantee.

26.11.2 Provided always that the Contractor shall not be entitled to submit a Request for Payment containing an application for the Advance Payment until it has demonstrated to the satisfaction of NATIS Representative that it has mobilised at the Project Site, consistent with its obligations under the Contract and has complied with its obligations under **Clause 3.3** [Following the Notice to Proceed].

26.11.3 The Contractor shall maintain each Advance Payment Guarantee so that they shall remain in full force and effect until the expiry of [28 (twenty-eight)] days from the date upon which the full amount of the Advance Payment shall have been repaid after which no claim shall be made against the said guarantee. The cost of obtaining Advance Payment Guarantee shall be at the expense of the Contractor and shall be deemed to be included in the Contract Sum.

26.11.4 The Contractor agrees and acknowledges that following payment by NATIS of the Advance Payment and provided that if NATIS is unable to deduct the Advance Payment, including the interest as mentioned in the special conditions of contract, NATIS at its discretion shall be entitled to demand the repayment of the whole or the remaining balance of the Advance Payment or to deduct so much of the outstanding amount thereof from amounts due and payable to the Contractor until the whole of the Advance Payment is repaid.





26.11.5 In addition to any other rights contained in the Contract, NATIS shall be entitled to recover the Advance Payment by making deductions from the Gross Certifiable Amount, or to redeem the Advance payment Guarantee from the issuer bank to recover the balance advance amount payable to NATIS.

26.11.6 The advance payment shall be fully repayable to NATIS by the contractor, within a specific time, as mentioned in the special conditions of contract, counted from the date of release of such payment. The repayment shall not be linked to the certificate of payments and the same shall be dealt separately through A/c. Payee cheque or demand draft as per the schedule given in the special conditions of contract. The contractor shall submit a fund utilisation certificate, giving details of expenditure of funds, spent towards the mobilisation of works, along with the last re-payment schedule.

26.11.7 No other advance payment shall be paid, such as material advance etc.

#### 26.12 Effect of Payment

The making of any payment shall in no event constitute the acceptance of any Works performed by Contractor pursuant to this Contract.

## 27. TAXES AND DUTIES

### 27.1 Contractor to pay Taxes

Unless specifically stated elsewhere in the Contract, the Contractor is solely liable for payment of, and warrants that it will pay, or ensure the payment of:

27.1.1 all Taxes imposed and assessments made in relation to the Contractor's Equipment, the Materials and the Works;

27.1.2 all contributions payable by any Applicable Law, award and pursuant to any contract with all industrial or trade union or other association of employees or otherwise with respect to or ascertained by reference to the wages, salaries or other compensation paid to employees of the Contractor or its Subcontractors in respect of the Works, including taxes or contributions for workers' compensation, unemployment or sickness benefit, old age benefit, welfare funds, pensions and disability insurance;

27.1.3 the cost of all import or export licences if required;





- 27.1.4 the cost of any port dues including (but not by way of limitation) wharfage dues, storage, charges, quay rent, craneage, shipping dues, pilotage fees, anchorage, berthage and mooring fees, quarantine dues, loading, portage and overtime fees for any Goods, Materials and equipment to be used in connection with the Execution of the Works;
- 27.1.5 all charges and other expenses in connection with the landing and shipment of all Goods and equipment and any part thereof, materials and other things of whatsoever nature brought into or despatched from India for the purposes of the Contract; and
- 27.1.6 the Contractor indemnifies and keeps indemnified NATIS against all liability for payment of all of the above Taxes, assessments and contributions, duties, costs and fees and all liability arising in respect of any non-payment.
- 27.2 **Withholding Tax/Income Tax deducted at source**

NATIS shall be entitled to deduct in accordance with Applicable Law, Income Tax or withholding tax or other deductions (as the case may be), from any payments made to the Contractor, and the amount so deducted shall be deemed to be a payment made to the Contractor. NATIS shall provide a certificate certifying the deduction so made.

**27.3 Exemptions and Concessions**

- 27.3.1 The benefit of any Tax exemption or concessional rate available when the Contractor purchases Materials will be passed on to NATIS through a reduction in the Contract Sum.
- 27.3.2 Where NATIS and its contractors (including the Contractor) are entitled to an exemption or concession concerning any Tax to be levied in India in respect to Goods supplied under the Contract, NATIS must use reasonable endeavours to enable the Contractor to claim such concession or exemption.

**27.4 General**

- 27.4.1 The Contractor must provide sufficient information regarding the nature and cost of the Works to enable all the relevant statutory obligations of NATIS that are dependent upon that information to be satisfied.
- 27.4.2 The Contractor shall fully indemnify, save harmless and defend NATIS including its officers, servants, agents and subsidiaries from and against any and all loss and damages arising out of or with respect to failure of the Contractor (a) to comply with Applicable Laws and Applicable Clearances and/or (b) to make payments of Taxes relating to the Contractor's Subcontractors and representatives income or other taxes required to be paid by the Contractor without reimbursement hereunder and/or (c) to pay amounts due as a result of materials or services furnished to the Contractor or any of its Subcontractors which are



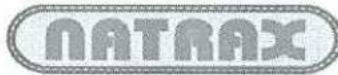

payable by the Contractor or any of its Subcontractors or any other person employed or engaged by the Contractor in connection with the Works.

## 28. NATIS

### 28.1 NATIS obligations

Notwithstanding anything contained in the Contract and in addition to and not in derogation or substitution of any of its other obligations under the Contract, NATIS shall:

- (i) provide all assistance and support to the Contractor to obtain from Statutory Authorities all Applicable Clearances other than those which are NATIS responsibility.
- (ii) use reasonable endeavours to assist the Contractor in the procurement of the peaceful use of the Project Site by the Contractor under and in accordance with the provisions of the Contract and without any let or hindrance from any Relevant Authority, Statutory Authority or persons claiming through or under it/them.

## 29. CONTRACTOR'S COVENANTS

### 29.1 Setting Out and Boreholes

29.1.1 The Contractor shall be responsible for:

- (i) the true and proper setting-out of the Works and for the correctness of the position, levels, dimensions and alignment of all parts of the Works; and
- (ii) the provision of all necessary instruments, appliances and labour in connection with the foregoing responsibilities.

29.1.2 If, at any time during the Execution of the Works, any error appears in the position, levels, dimensions or alignment of any part of the Works, the Contractor, on being required so to do by the NATIS Representative, shall, at its own cost and with no entitlement to any extension of time, rectify such error to the satisfaction of the NATIS Representative.

29.1.3 The checking of any setting-out or of any line or level by the NATIS Representative shall not in any way relieve the Contractor of its responsibility for the accuracy thereof and the Contractor shall carefully protect and preserve all bench-marks, sight-rails, pegs and other



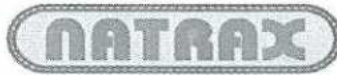

things used in setting-out the Works. Any instruction given by the NATIS Representative pursuant to this **Clause 29.1 [Setting out and Bore Holes]** shall not be deemed to be a Change Order and the Contractor shall not be entitled to any extension of time or additional payment in respect thereof.

#### 29.1.4 Boreholes and exploratory excavations

29.1.4.1 If at any time during the Execution of the Works, the Contractor considers it necessary or desirable to make boreholes or to carry out exploratory excavation or investigations of the ground it shall apply to NATIS Representative for permission to do so, giving details of its reasons and proposed boring methods. Such permission shall not be unreasonably refused or delayed by the NATIS Representative.

29.1.4.2 The Contractor shall observe such requirements in connection therewith as the NATIS Representative may impose as a condition of any permission it may give and shall furnish to the NATIS Representative full details of such work, including borehole logs, and of any interpretation and conclusions which it, or any Subcontractor undertaking such work on its behalf, makes or reaches based on such information as may be obtained from such work. All such work shall be undertaken at the expense of the Contractor and the Contractor shall be responsible for such use as it may make of the results thereof. Any third party carrying out such work shall be deemed for the purposes of the Contract to be a Subcontractor.

#### 29.2 Urgent repairs

If, by reason of any accident or failure or an Emergency or other event occurring to, in or in connection with the Works or any part thereof during the period of the Contract, any remedial work or repair shall, in the opinion of NATIS Representative, be urgently necessary and the Contractor is unable or unwilling or not available at once to do such work or repair, NATIS may by its own or other workmen do such work or repair as NATIS Representative may consider necessary. If the work or repair so done by NATIS is work which, in the opinion of the NATIS Representative, the Contractor was liable to do at its own expense under the Contract, all costs and charges properly incurred by NATIS in so doing shall within [14 (fourteen)] days from the date of receipt of the claim be paid by the Contractor to NATIS or may without prejudice to any other method of recovery, be deducted by NATIS from any monies due or which may become due to the Contractor or may be recovered as a debt.





### 29.3 Increased Monitoring and Right to Open Up

#### 29.3.1 Increased monitoring

29.3.1.1 If, following any viewing, visit or inspection of the Project Site, it is discovered that there are defects in the Works or that the Contractor has failed to comply with the Technical Conditions of the Contract, the NATIS Representative may (without prejudice to any other right or remedy available to it) by notice to the Contractor:

- (i) specify the defect requiring rectification and the period for rectifying the same which shall be within [7 (seven)] days of the date of the notice or such other time as, in the opinion of the NATIS Representative, is reasonable. If the Contractor has been notified of a defect(s) in accordance with this Clause 29.3.1 [Increased monitoring] and has failed to rectify it within the relevant period the cost incurred by NATIS in the rectifying of the defect(s) as certified by the NATIS Representative, shall be paid by the Contractor to NATIS or may, without prejudice to any other method of recovery, be deducted by NATIS from any monies due to the Contractor or may be recovered as a debt due and payable to NATIS on demand;
- (ii) require the Contractor to implement measures to avoid such defects re-occurring;
- (iii) require the Contractor to increase its quality assurance and quality control resources; and
- (iv) increase the level of the NATIS Representative's monitoring of the Contractor until such time as the Contractor shall have demonstrated to the satisfaction of the NATIS Representative that it is capable of performing and will perform all its obligations under the Contract.

29.3.1.2 The NATIS Representative may identify and instruct that work forming or intended to form part of the Works shall not be covered up or put out of view without the consent of the NATIS Representative. The Contractor shall give reasonable notice to the NATIS Representative before any such work is to be so covered up and shall afford the NATIS Representative the opportunity of inspection before the work is covered up.

29.3.2 Subject to the Clause 29.3.3 [Right to open up] the NATIS Representative shall have the right at any time to request the Contractor to open up and/or inspect and test any part or parts of the Works and any Materials where the NATIS Representative reasonably believes that such part or parts of the Works is or are defective and the Contractor shall comply with such request.





29.3.3 If, following the exercise by the NATIS Representative of its right pursuant to **Clause 29.3.2** [Right to open up], the inspection shows that the relevant part or parts of the Works or any Materials is or are defective, the Contractor shall rectify and make good such defect(s) and any consequence of such rectification and/or making good defect(s) shall be carried out by the Contractor at no cost to NATIS (including without limitation, any reinstatement) and the Contractor shall not be entitled to any extension of time in relation to such rectification and making good of the Works. If the inspection shows such part or parts of the Works or any Materials is or are not defective, the NATIS Representative shall, after due consultation with the Contractor, determine the Contractor's costs in respect of uncovering and reinstating the same, which shall be added to the Contract Sum, unless the NATIS Representative had reasonable grounds to believe that such part or parts of the Works or any Materials were defective.

#### 29.4 Improper work

The NATIS Representative, without prejudice to the generality of its powers, shall have the authority to issue instructions (which shall be effected by the Contractor with all reasonable speed and at its sole expense without any right to an extension of time) from time to time for:

29.4.1 the removal from the Project Site, within such time or times as may be specified in the instruction, of any part of the Works which, in the opinion of the NATIS Representative, are not in accordance with the Contract;

29.4.2 the substitution of proper and suitable part of the Works;

29.4.3 the removal and proper re-Execution, notwithstanding any previous test thereof or interim payment therefor, of any work which, in respect of any workmanship or design by the Contractor is not, in the reasonable opinion of the NATIS Representative, in accordance with the Contract; and

29.4.4 such testing, as it may consider necessary or desirable following any instruction issued pursuant to this **Clause 29.4** [Improper work ].

#### 29.5 Suspension

29.5.1 The NATIS Representative may suspend (i) progress or performance of all or any part of the Works (ii) delivery of any Materials or any part thereof or Contractor's Equipment which is ready for delivery to the Project Site by an order (herein called a "Suspension Order") issued to the Contractor in writing with a copy to NATIS where:





- (i) it is necessary by reason of some act, default, omission or breach by the Contractor (or those it is contractually responsible for) or a matter for which it is responsible or by reason of some default or breach reasonably anticipated by the NATIS Representative; or
- (ii) it is necessary for the proper Execution of the Works; or
- (iii) it is necessary in accordance with Clause 13.5.1 [Failure to co-ordinate]; or
- (iv) an unsafe condition or Emergency exists or is likely to result at the Works or any part of the Project Site; or
- (v) it is a necessary consequence of an action of any Statutory Authority.

29.5.2 A Suspension Order shall be final, conclusive and binding on the Contractor. On receipt of a Suspension Order, the Contractor shall immediately suspend any delivery or any part or all of the Works as the case may be, for such time and in such manner as the NATIS Representative may consider necessary and immediately advise the NATIS Representative of any aspects of the Works which need to be continued to maintain the safety and security of the Works.

29.5.3 Following receipt of a Suspension Order the Contractor shall during any suspension, properly protect and secure the Works and the Goods and shall not remove any Goods from the Project Site without the prior consent of the NATIS Representative and the Contractor shall take all reasonable measures to minimise the costs and losses of the suspension to NATIS and the Contractor, including meeting with the NATIS Representative on a regular basis.

29.5.4 The Contractor shall, in a reasonable time, undertake any necessary action instructed by the NATIS Representative to remedy the circumstances that led to the issue of a Suspension Notice and the Contractor shall notify the NATIS Representative immediately upon completing such action. The NATIS Representative shall within [7 (seven)] days of receipt of such notice either instruct the Contractor to resume the Works or identify by means of a further written notice the additional action which is required to be taken by the Contractor before an instruction to resume can be given.

29.5.5 The NATIS Representative may at any time instruct the Contractor to resume the Works or such part of the Works that are the subject of a Suspension Order, in which case the Contractor shall do so as soon as is reasonably practicable and in any event within [20 (twenty)] days of such instruction. Upon resumption of the Works, the Contractor shall immediately undertake an examination of the affected parts of the Works and shall make good any deterioration or defect in or loss of the Works, the Materials or any part thereof that may have occurred during the suspension.





29.5.6 In the event that the NATIS Representative issues a Suspension Order in accordance with **Clause 29.5.1 (i) to (iv)** [Suspension] the Contractor shall not be entitled to any addition to the Contract Sum or any extension of time. The Contractor shall not be entitled to any addition to the Contract Sum or to any extension of time where the necessity to issue such a Suspension Order was due in any way to the act, default, omission or breach by the Contractor (or those it is contractually responsible for) or a matter for which it is responsible or by reason of some default or breach reasonably anticipated by the NATIS Representative.

## 29.6 Audit

29.6.1 It is an agreed term of the Contract that NATIS reserves to itself the right to carry out a pre payment audit of the Final Payment including all supporting vouchers, abstracts, etc.

29.6.2 It is an agreed term of the Contract, that NATIS reserves to itself or through its nominee the right to carry out a post payment audit and / or technical examination of the Works, and the Final Payment including all supporting vouchers, abstracts, etc., and to make a claim on the Contractor for the refund of any excess amount paid to the Contractor, if as a result of such examination, any over-payment to the Contractor is discovered to have been made in respect of any Work done or alleged to have been done by the Contractor, under the Contract. Such payments or recoveries, however, shall not carry any interest.

29.6.3 Without prejudice to **Clause 29.6.1 [Audit]** and **Clause 29.6.2 [Audit]**, the Contractor shall maintain complete and accurate records in respect of the design and Execution of the Works and in connection with the Contract and all transactions related thereto during the Design and Execution Period and in accordance with the NATIS Representative instructions. The system of accounting to be employed by Contractor shall be in accordance with NATIS's practices, and Contractor's records and books of account referred to above and all supporting documents shall be maintained in such a manner as to provide an audit trail and as to facilitate any examination and audit thereof by NATIS.

29.6.4 Any of the Contractor's records offices shall be maintained in accordance with the Technical Specifications and Drawings and all such records contained therein shall be maintained for at least [5 (five)] years after the issue of the Defects Rectification Certificate ("Audit Period"). NATIS and/or its duly authorised representatives shall have, during the Audit Period, the right to audit, examine, and make photocopies of all accounts, records, correspondence, manuals, drawings and all other documents, including but not limited to all labour hours and costs, material costs, subcontract costs, rental costs and other charges pertaining to the Contract to verify the amounts and reliefs claimed and to verify compliance with the terms and conditions hereof and with the Applicable Laws.

29.6.5 The Contractor shall make the accounts, records, correspondence, manuals and drawings and all other documents referred to in **Clause 29.6.4 [Audit]** available for inspection on reasonable notice and during normal business hours to the NATIS Representative and any persons authorised by the NATIS Representative and shall furnish copies of the same, at NATIS cost, if called for.





- (i) This **Clause 29.6 [Audit]** shall extend to transactions with third parties when the transactions are deemed by NATIS to relate, actually or potentially, to performance under the Contract and compliance with Applicable Laws.
- (ii) To the extent the any accounts, records, correspondence, manuals and drawings and all other documents referred to in this **Clause 29.6 [Audit]** are to be created or maintained on a computer or other electronic storage device, the Contractor shall comply with any reasonable request of the NATIS Representative from time to time relating to procedures for the back-up and off-site storage of copies of such records.
- (iii) Upon termination of the Contractor's employment for whatever reason under the Contract, the Contractor shall make all such arrangements to deliver the records referred to in the notice to NATIS or its nominee in as complete a form as required under the Contract at such time, in such manner and at such location as the NATIS Representative shall reasonably specify

## **29.7 Illegal gratification**

- 29.7.1 Bribe, commission, gift or advantage: Any bribe, commission, gift or advantage given or offered by the Contractor directly or through its partner, agent or any officer or employee of NATIS, or to any person / institution connected with NATIS, in relation to obtaining or the execution of this or any other Contract with the NATIS Representative or NATIS, shall in addition to any criminal liability which the Contractor may incur, subject the Contractor to termination of the Contract and all other Contracts with NATIS, and liability for payment of any loss or damage to NATIS, resulting from such termination. NATIS shall be entitled to deduct the amounts so payable from any money / moneys due to the Contractor alone, or jointly under the Contract or any other contract with NATIS. The Contractor shall not be due, nor shall be paid any compensation whatsoever for any loss, alleged or actual, suffered by the Contractor when the Contract is so terminated.
- 29.7.2 Monetary dealing of Contractor with employee of NATIS or NATIS Representative: The Contractor shall not lend or borrow money from, or enter into any monetary dealings or transactions directly or indirectly, with any employee of NATIS Representative or NATIS, and if the Contractor does so, NATIS shall be entitled forth-with to terminate the Contract and all other Contracts with NATIS. The Contractor shall be liable to pay compensation for any loss or damage to NATIS resulting from such termination and NATIS shall be entitled to deduct the amounts so payable from the money(s) due to the Contractor.
- 29.7.3 Settlement of dispute as to commission of such offence: If any question or dispute as to the commission of any such offence arises under Sub-clauses (bribe, commission, gift or advantage) and (monetary dealer of Contractor with employee of NATIS or NATIS Representative), the same shall be settled by NATIS Representative, in such manner as the NATIS Representative shall consider fit and proper, and such decision shall be final and binding.





## 29.8 Avoidance of Damage to Roads and Bridges

### 29.8.1 Contractor to prevent damage to roads and bridges

29.8.1.1 The Contractor shall use every reasonable means to prevent any of the highways, railway or bridges communicating with or on the routes to the Project Site (including access and link roads) from being damaged or injured by any traffic of the Contractor or any of its Subcontractors. In particular the Contractor shall select routes, choose and use vehicles and restrict and distribute loads so that any such extraordinary traffic as will inevitably arise from the moving of plant and materials to and from the Project Site shall be limited as far as reasonably possible and so that no unnecessary damage or injury may be occasioned to such highways, railways and bridges.

29.8.1.2 Should it be found necessary for the Contractor to move one or more loads of Contractor's Equipment, machinery or pre-constructed units or part of units of works over part of a highway railway or bridge, the moving whereof is likely to damage any highway, railway or bridge unless special protection or strengthening is carried out, then the Contractor shall before moving the load on to such highway, railway or bridge give notice to the appropriate authority of the load to be moved and obtain the required approval of the said authorities for its proposals for protecting or strengthening the said highway, railway or bridge. The Contractor shall be responsible for the cost and expenses of any necessary work for the protection or strengthening the said highway, railway or bridge.

### 29.8.2 Transport of Materials and Contractor's Equipment

The Contractor shall indemnify and hold harmless NATIS from and against any claims, proceedings, damages, costs, charges or expenses in respect of damage to any highway, railway, bridges or any other traffic facilities or route for vehicular movement and/or persons that may be caused by the traffic of the Contractor or any of its Subcontractors.

### 29.8.3 Access routes

The Contractor shall be deemed to have been satisfied as to the safety, suitability and availability of access routes up to the Project Site. Without prejudice to the generality of the foregoing:

29.8.3.1 NATIS shall not be responsible for any claims which may arise from the use or otherwise of any access route to, from and over the Project Site;





29.8.3.2 NATIS does not guarantee the suitability or availability of particular access routes and all costs due to non-suitability or non-availability, for the use required by the Contractor, of access routes shall (as between the Parties) be borne by the Contractor;

29.8.3.3 the Contractor shall provide such signs or directions along access routes to, from and over the Project Site as required by the Technical Specifications and Drawings and shall obtain any permission which may be required for the provision of such signs and directions; and

29.8.3.4 without prejudice to its obligations under Clause 22.1 [Defects rectification by the Contractor] the Contractor shall (as between the Parties) be responsible for the maintenance of access routes over the Project Site until the Completion.

#### 29.8.4 Road Diversions

Where it is necessary that operations required for the Execution of the Works or any part thereof interfere with the use or occupation of or access to any public or private roads or footpaths the Contractor shall, before it commences such operations, apply for and obtain the written approval therefor from the relevant Statutory Authority or the permission of the person affected, as the case may be, and shall observe all the requirements that the same in order to be allowed to interfere with any public or private roads or footpaths. The Contractor shall give the NATIS Representative prior notice of all operations referred to in this Clause 29.8.4 [Road Diversions] and shall, as the same takes place, send copies to it of all correspondence and inform it of all discussions relating to such operations and the work undertaken.

#### 29.8.5 Contractor not to interfere

All operations necessary for the Execution of the Works or any part thereof shall, so far as compliance with the requirements of the Contract permits, be carried on so as not to interfere unnecessarily or improperly with any or with the convenience of the public, or the access to, use and occupation of public or private roads or footpaths or any properties (adjoining the Project Site or otherwise) whether in the possession of NATIS or of any other person.

#### 29.8.6 Waterborne traffic

Where the nature of the Works is such as to require the use by the Contractor of waterborne transport the forgoing provisions of this Clause 29.8 [Avoidance of damages to roads and bridges] shall be construed as though "road" included a lock, dock, sea wall or other structure related to a waterway and "vehicle" included craft, and shall have effect accordingly.

### 29.9 Care of the Works, Liability for Accidents and Damage

#### 29.9.1 Contractor to take full responsibility for care of the Works





29.9.1.1 The Contractor shall bear full risk in and take full responsibility for the care of the Works (and, without limitation for the care of any works carried out on the Project Site by other contractors) from the date of issue of the Notice to Proceed until [14 (fourteen)] days after the date of issue of the Completion Certificate, when such responsibility for the care of the Works shall pass to NATIS as instructed to the Contractor by the NATIS Representative.

Provided that the Contractor shall take full responsibility for (i) the care of any outstanding Works for incorporation therein which it undertakes to finish during the Defects Rectification Period until such outstanding Works have been completed pursuant to the Contract and for (ii) the care of the Works or any part thereof which may require repair or remedy during the Defects Rectification Period and Latent Defects Rectification Period and for any part of the Works affected thereby, for the period that such Works are under repair or remedy by the Contractor.

#### 29.9.2 Responsibility to rectify loss or damage

29.9.2.1 If any loss or damage happens or occurs to the Works or any part thereof during the period for which the Contractor is responsible for their care in accordance with Clause 29.9.1 [Contractor to take full responsibility for care of the Works], the Contractor shall rectify the loss or damage at the Contractor's risk and cost, so that the Works conform in every respect with the provisions of the Contract and are to the satisfaction of the NATIS Representative.

29.9.2.2 For the avoidance of doubt and without limiting the Contractor's liability under the remainder of the Contract, the Contractor shall also be liable for any loss or damage to the Works:

- (i) which occurs after the Completion Certificate for the Works has been issued and which arose from a previous event for which the Contractor was liable.
- (ii) occasioned by the Contractor in the course of any operations carried out by it for the purpose of complying with any of its obligations under Clause 22 [Defects Rectification Period].

#### 29.9.3 Damage to persons and property

The Contractor indemnifies and keeps indemnified NATIS against all losses and claims for death, injuries or damage to any person or any property whatsoever which may arise out of or in consequence of the design and Execution of the Works and the remedying of any defects therein and against all claims demands, proceedings, damages, costs, charges and expenses whatsoever in respect thereof or in relation thereto.



## 29.10 Clearance of the Project Site

On completion of the Works, the Contractor shall clear away and remove from the Project Site all equipments, surplus materials, rubbish and Temporary Works of every kind and leave the whole of the Project Site and the Works clean and in a workmanship condition, tidy and in an aesthetically pleasing appearance to the satisfaction of NATIS and the NATIS Representative. The Contractor shall, unless otherwise instructed in writing by NATIS Representative, remove all signs of temporary construction facilities such as haul roads, work areas, structures, foundations of Temporary Works, stockpiles of excess or waste materials and other vestiges of construction prior to the issue of the Completion Certificate

## 30. FORCE MAJEURE

### 30.1 Force Majeure - Obligations of the Parties

30.1.1 "Force Majeure" shall mean any event beyond the control of NATIS or of the Contractor, as the case may be, and which is unavoidable notwithstanding the reasonable care of the party affected, and which could not have been prevented by exercise of reasonable skill and care and good industry practices and shall include, without limitation, the following:

- (i) War, hostilities, invasion, act of foreign enemy and civil war;
- (ii) Rebellion, revolution, insurrection, mutiny, conspiracy, riot, civil commotion and terrorist acts;
- (iii) Strike, sabotage, unlawful lockout, epidemics, quarantine and plague;
- (iv) Earthquake, fire, flood or cyclone, or other natural disaster.

As soon as reasonably practicable but no more than 48 (forty-eight) hours following the date of commencement of any event of Force Majeure, an Affected Party shall notify the other Party of the event of Force Majeure setting out, inter alia, the following in reasonable detail:

30.1.2 the date of commencement of the event of Force Majeure;

30.1.3 the nature and extent of the event of Force Majeure;

30.1.4 the estimated Force Majeure Period,

30.1.5 reasonable proof of the nature of such delay or failure and its anticipated effect upon the time for performance and the nature of and the extent to which, performance of any of its obligations under the Contract is affected by the Force Majeure.





- 30.1.5 the measures which the Affected Party has taken or proposes to take to alleviate/mitigate the impact of the Force Majeure and to resume performance of such of its obligations affected thereby.
- 30.1.6 any other relevant information concerning the Force Majeure and /or the rights and obligations of the Parties under the Contract.

### 30.2 Meetings with NATIS Representative

As soon as reasonably practicable and in any case within [5 (five)] days of notification by the Affected Party in accordance with the preceding **Clause 30.1 [Force Majeure - Obligations of the Parties]**, the Parties shall along with NATIS Representative and others, meet and hold discussions and where necessary conduct physical inspection and/or survey of the Works in order to:

- 30.2.1 assess the impact of the event of Force Majeure; and
- 30.2.2 to determine the likely duration of the Force Majeure Period; and
- 30.2.3 to formulate damage mitigation measures and steps to be undertaken by the Parties for resumption of obligations the performance of which shall have been affected by the underlying Force Majeure.

### 30.3 Reporting during the Force Majeure Period

The Affected Party shall during the Force Majeure Period provide to the other Party and NATIS Representative with regular (not less than weekly) reports concerning the matters set out in **Clause 30.2 [Meetings with NATIS Representative]** in addition to any other information, details or document, which the other Party or NATIS Representative may reasonably require.

### 30.4 Performance obligations

- 30.4.1 If the Affected Party is rendered wholly or partially unable to perform any of its obligations under the Contract because of an event of Force Majeure, it shall be excused from performance of such obligations to the extent it is unable to perform the same on account of such Force Majeure, provided that in case the Affected Party is the Contractor, the Contractor shall be entitled to an extension of time under **Clause 19 [Extension of Time for Completion]**.





30.4.2 When the Affected Party is able to resume performance of its obligations under the Contract, it shall give to the other Party written notice to that effect forthwith and shall promptly resume performance of its obligations hereunder.

30.4.3 The Affected Party shall continue to perform such of its obligations which are not affected by the event of Force Majeure and which are capable of being performed in accordance with the Contract.

30.5 Liability for other losses, damages etc.

Save and except as expressly provided in this **Clause 30 [Force Majeure]** neither Party hereto shall be liable in any manner whatsoever to the other Party in respect of any loss, damage, cost, expense, claims, demands and proceedings relating to or arising out of occurrence or existence of any event of Force Majeure.

### 30.6 Exceptions to Force Majeure

None of the following events shall be construed to relieve any Party of its obligations hereunder by reason of **Clause 30 [Force Majeure]**:

- (i) any changes in market conditions including without limitation changes that affect the supply prices of the Goods;
- (ii) commercial impracticability or hardship;
- (iii) a Party's lack of funds.

## 31. DISPUTE RESOLUTION PROCEDURE

### 31.1 Amicable Resolution and Mediation

31.1.1 Save where expressly stated to the contrary in the Contract, any dispute, difference or controversy of whatever nature between the Parties, howsoever arising under, out of or in relation to the Contract including disputes, if any, with regard to any acts, decision or opinion of NATIS Representative and so notified in writing by either Party to the other (the "Dispute") shall in the first instance be attempted to be resolved amicably in accordance with the procedure set out in **Clause 31.1.2 [Amicable Resolution and Mediation]** below.

31.1.2 Either Party may require such Dispute to be referred to a person nominated by each Party, for amicable settlement. Upon such reference, the two shall meet at the earliest mutual convenience and in any event within [15 (fifteen)] days of such reference to discuss and attempt to amicably resolve the Dispute.





31.1.3 In the event that the Dispute in question is not resolved amicably within 15 (fifteen) days of such meeting between the Parties in accordance with **Clause 31.1.2** [Amicable Resolution and Mediation] either Party may refer the Dispute to arbitration in accordance with **Clause 32.2** [Arbitration Procedure].

### **31.2 Arbitration Procedure**

Save where expressly stated to the contrary in the Contract, any Dispute shall be finally settled by binding arbitration under the Arbitration and Conciliation Act 1996 Act and in accordance with the UNICTRAL rules (the "Arbitration Rules") by three arbitrators appointed in accordance with the Arbitration Rules.

### **31.3 Place of Arbitration**

The place of arbitration shall be New Delhi.

### **31.4 English Language**

The request for arbitration, the answer to the request, the terms of reference, any written submissions, any orders and awards shall be in English and, if oral hearings take place, English shall be the language to be used in the hearings.

### **31.5 Enforcement of Award**

The Parties agree that the decision or award resulting from arbitration shall be final and binding upon the Parties and shall be enforceable in accordance with the provisions of the Arbitration and Conciliation Act.

### **31.6 Performance during Arbitration**

Pending the submission of and/or decision on a Dispute and until the arbitral award is published, the Parties shall continue to perform their respective obligations under the Contract without prejudice to a final adjustment in accordance with such award.

## **32. REPRESENTATIONS AND WARRANTIES, DISCLAIMER**

### **32.1 Representations and Warranties of the Contractor**

The Contractor represents and warrants to NATIS that:





- 32.1.1 it is duly organised, validly existing and in good standing under the laws of [the country of its incorporation] ;
- 32.1.2 it has full power and authority to execute, deliver and perform its obligations under the Contract and to carry out the transactions contemplated here by;
- 32.1.3 it has taken all necessary corporate and other action under Applicable Laws and its constitutional documents to authorise the Execution, delivery and performance of the Contract;
- 32.1.4 it has the financial standing and capacity to design and Execute the Works;
- 32.1.5 the Contract constitutes its legal, valid and binding obligation enforceable against it in accordance with the terms here of;
- 32.1.6 it is subject to the Applicable Laws with respect to the Contract and it hereby expressly and irrevocably waives any immunity in any jurisdiction in respect there of;
- 32.1.7 the execution, delivery and performance of this Contract will not conflict with, result in the breach of, constitute a default under or accelerate performance required by any of the terms of the Contractor's Memorandum and Articles of Association or any Applicable Laws or any covenant, contract, understanding, decree or order to which it is a party or by which it or any of its properties or assets are bound or affected;
- 32.1.8 there are no actions, suits, proceedings or investigations pending or to the Contractor's knowledge threatened against it at law or in equity before any court or before any other judicial, quasi judicial or other authority, the outcome of which may result in a Material Adverse Effect upon the Works;
- 32.1.9 it has no knowledge of any violation or default with respect to any order, writ, injunction or any decree of any court or any legally binding order of any Statutory Authority which may result in a Material Adverse Effect upon the Works;
- 32.1.10 it has complied with all Applicable Laws and has not been subject to any fines, penalties, injunctive relief or any other civil or criminal liabilities which in the aggregate have or may have Material Adverse Effect upon the Works;
- 32.1.11 no representation or warranty by the Contractor contained herein or in any other document furnished by it to NATIS or to any Statutory Authority in relation to Applicable Clearances contains or will contain any untrue statement of material fact or omits or will omit to state a material fact necessary to make such representation or warranty not misleading; and





32.1.12 no bribe or illegal gratification has been paid or will be paid in cash or kind by or on behalf of the Contractor to any person to procure the Contract or any other benefit under the Contract to procure other Contracts in relation to which the Contractor may be a party in relation to the Project.

32.1.13 without prejudice to any express provision contained in the Contract, the Contractor acknowledges that prior to the execution of the Contract, the Contractor has after a complete and careful examination made an independent evaluation of the Project Site, the Technical Specifications and Drawings and any information provided by or on behalf of NATIS and has made an inspection of the Project Site and has determined to its satisfaction the nature and extent of risks and hazards as are likely to arise or may be faced by the Contractor in the course of performance of its obligations hereunder.

### 33. TERMINATION

#### 33.1 Termination

33.1.1 Subject to the other provisions of the Contract, NATIS shall have the right to serve a notice of termination of the Contract on the Contractor and forthwith terminate the Contract without prejudice to any of its other rights and remedies against the Contractor and without being liable to pay any loss or compensation if:

- (i) the Contractor fails to pay any amount due and payable under the Contract within [21 (twenty one)] days of receipt of notice given by NATIS of such non-payment;
- (ii) if any distress or execution is levied upon any of the assets of the Contractor;
- (iii) at any time during the currency of the Contract there is a change in the effective control of the Contractor as at the date of the Contract;
- (iv) the Contractor fails to complete, test and commission the Contractor's Works/Project Facility within the Time for Completion or commits any other violation/breach of the terms and conditions of the Contract which is not rectified within [14 (fourteen)] days of the date of receipt of notice from NATIS in this regard.
- (v) any of the following events occurs:
  - (a) the passing of a resolution by the shareholders of the Contractor for the winding up of the Contractor;





- (b) the appointment of a liquidator in a proceeding for the winding up of the Contractor or the Contractor entering into a compromise with its creditors; or
- (c) the making by the court of an order winding up the Contractor,
- (d) The Contractor either:
  - (i) Appoints a subcontractor without the prior approval of NATIS, or terminates any of the Subcontractor; or
  - (ii) having terminated any of the Subcontracts with the consent of NATIS, appoints a replacement Sub-Contractor without the prior approval of NATIS.
- (e) the Contractor without the consent of NATIS assigns or transfers all or any of its rights or obligations under the Contract;
- (f) the Contractor repudiates the Contract or otherwise evidences an intention not to be bound by the Contract; or
- (g) the expropriation, confiscation or compulsory acquisition of the Project Facility;
- (h) as a result of Force Majeure, the Contractor is unable to proceed with the Works for a period of [90(ninety)] consecutive days or [180(One Hundred and Eighty)] days in a year (whichever is less);
- (i) if the Contractor or any of its servants or agents commit or suffer to be committed or omit or suffer to be omitted any act, deed, matter or thing which in the opinion of NATIS Representative whose decision (without an obligation to give reasons therefor) in this regard will be final, is prejudicial to the interests or reputation of NATIS.
- (j) the Contractor offers, gives or promises any payment directly or indirectly to any government, political party, or official thereof, or any candidate for political office, or to NATIS in order to influence any substantive decision of, or induce any party or person to use its influence to offset any





substantive decision of any Relevant Authority or Statutory Authority or NATIS in regard to any aspect of the Contract;

- (k) the Contractor makes any warranty or representation in or in accordance with the Contract which was materially incorrect when made so as to materially affect NATIS's interests; or
- (l) in the event that the Contractor's liability for Liquidated Damages reaches the cap on such damages as set out in Special Conditions of Contract and the Completion Certificate for the whole of the Works has not been issued; or
- (m) fails to provide, maintain or renew and/or comply with its obligations in relation to the Performance Security; or
- (vi) the Contractor has, without valid reason and NATIS's consent, failed to commence the Works promptly, or fails to progress the Works regularly and/or diligently, or has suspended the progress of the Works for more than [7 (seven) days;] or
- (vii) the Contractor has failed to adhere to the Technical Specifications and Drawings and in the reasonable estimation of the NATIS Representative, such failure is likely to mean that Completion of the Works is likely to be delayed beyond the relevant Time for Completion; or
- (viii) the Contractor's personnel is/are incompetent, have acted in a manner prejudicial to NATIS's best interest or have failed to comply with NATIS's health, safety, environment or other rules or regulations and procedures; or
- (ix) the Contractor has failed to achieve two Milestones consecutively.

### 33.2 Termination Procedure

33.2.1 A notice of termination given pursuant to this **Clause 33 [Termination]** (each a "Preliminary Termination Notice") shall specify in reasonable detail the circumstances giving rise to the Preliminary Termination Notice. If, within [21 (twenty one)] days following the service by NATIS of a Preliminary Termination Notice, the Contractor pays all sums which are due and payable to NATIS or remedies the breach to the satisfaction of NATIS existing as at the date of the Preliminary Termination Notice then:-

- (i) such Preliminary Termination Notice shall be revoked and all existing rights of termination in favour of NATIS under the Contract shall terminate (but without





prejudice to any rights of NATIS in respect of any future breach of the Contract); and

- (ii) The Contractor shall continue to perform its obligations under the Contract in a diligent and proper manner.

33.2.2 Within the period of [21 (twenty one)] days following the receipt of the Preliminary Termination Notice by the Contractor and unless the Parties shall have otherwise agreed or the circumstances giving rise to the Preliminary Termination Notice shall have ceased to exist or shall have not been remedied, NATIS may terminate the Contract by giving written notice (a "Termination Notice") to the Contractor and the Contract shall terminate on the date mentioned in the Termination Notice ("Termination Date").

33.2.3 The termination of the Contract by NATIS for reasons other than breach can be made by a written notice to the Contractor and nothing herein will obligate NATIS to terminate the Contract or be liable for any exercising its right of termination and NATIS may pursue all remedies available in law instead of termination.

### 33.3 Upon Termination

33.3.1 Upon Termination for any reason whatsoever, the Contractor shall to the extent instructed by the NATIS's Representative:

- (i) cease all further work as instructed by the NATIS's Representative in the Termination Notice and the Contractor shall carry out works for the sole purpose of securing, preserving and protecting that part of the Works already Executed and any work required to leave the Project Site and the Works in a clean and safe condition;
- (ii) remove all the Contractor's Equipment and Temporary Works;
- (iii) repatriate the Contractor's and Subcontractor's personnel from any part of the Project Site and the Works;
- (iv) deliver to NATIS the Works Executed by the Contractor as at the Termination Date;
- (v) ensure that it and those it is contractually or otherwise responsible for, vacate the Project Site;
- (vi) deliver to NATIS "as built drawings" showing all work carried out since commencement of the Works; and
- (vii) promptly and in an orderly manner deliver to NATIS all documents relating to the Works which are for the time being under the control of the Contractor;

33.3.2 Without prejudice to **Clause 33.3.1** [Upon Termination] upon Termination:

- (i) NATIS may enter the Project Site and the Works thereof and expel the Contractor therefrom and NATIS may complete the Works itself or by employing any third party;





- (ii) NATIS may, to the exclusion of any right of the Contractor over the same, take over and have free use, without payment to the Contractor, of any Contractor's Equipment and Temporary Works of which have been delivered to the Project Site for such period as the NATIS's Representative considers necessary for the Execution of the Works, without being responsible to the Contractor for fair wear and tear thereof and to the exclusion of any right of the Contractor over the same.
- (iii) NATIS may at any time sell any of the said Contractor's Equipment, Temporary Works and any unused materials and apply the proceeds of sale in or towards for satisfaction of any sums due or which may become due to it from the Contractor under the Contract; and
- (iv) NATIS shall have the power and authority to prohibit the Contractor and any person claiming through or under the Contractor from entering the Project Site.

## 34. MISCELLANEOUS

### 34.1 Assignment and Charges

34.1.1 Subject to **Clauses 34.1.2 [Assignment and Charges]**, neither Party shall assign the Contract or the rights, benefits and obligations hereunder save and except with prior consent of the other Party.

34.1.2 The Contractor shall not create nor permit to subsist any Encumbrance over or otherwise transfer or dispose of all or any of its rights and benefits under the Contract except with prior consent in writing of NATIS, which consent shall not be unreasonably withheld.

### 34.2 Interest

Any sum which becomes payable under any of the provisions of the Contract by one Party to the other Party shall, if the same be not paid within the time allowed for payment thereof, shall be deemed to be a debt owed by the Party responsible for payment thereof to the Party entitled to receive the same. Such sum shall until payment thereof carry the Default Interest Rate from the due date for payment thereof until the same is paid to or otherwise realised by the Party entitled to the same.

However an interest as specified in the SCC shall be charged to the contractor towards the advance payment till such payment is fully recovered by NATIS.

### 34.3 Governing Law and Jurisdiction

The Contract shall be governed by the laws of India. In respect of all matters arising out of or relating to the Contract, the Courts at New Delhi, India.





#### 34.4 Waiver

34.4.1 Waiver by either Party of any default by the other Party in the observance and performance of any provision of or obligations under the Contract:

- (i) shall not operate or be construed as a waiver of any other or subsequent default hereof or of other provisions or obligations under the Contract;
- (ii) shall not be effective unless it is in writing and executed by a duly authorised representative of such Party; and
- (iii) shall not affect the validity or enforceability of the Contract in any manner.

34.4.2 Neither the failure by either Party to insist on any occasion upon the performance of the terms, conditions and provisions of the Contract or any obligation hereunder nor time or other indulgence granted by a Party to the other Party shall be treated or deemed as waiver/breach of any terms, conditions or provisions of the Contract.

#### 34.5 Survival

Termination or expiry of the Contract (i) shall not relieve NATIS or the Contractor of any obligations already incurred hereunder which expressly or by implication survives termination hereof, and (ii) except as otherwise provided in any provision of the Contract expressly limiting the liability of either Party, shall not relieve either Party of any obligations or liabilities for loss or damage to the other Party arising out of or caused by acts or omissions of such Party prior to the effectiveness of such termination or arising out of such termination.

#### 34.6 Amendments

The Contract constitutes a complete and exclusive understanding of the terms of the Contract between the Parties on the subject hereof and no amendment or modification hereto shall be valid and effective unless agreed to by all the Parties hereto and evidenced in writing.

#### 34.7 Severability

If for any reason whatsoever any provision of the Contract is or becomes invalid, illegal or unenforceable or is declared by any court of competent jurisdiction or any other instrumentality to be invalid, illegal or unenforceable, the validity, legality or enforceability of the remaining provisions shall not be affected in any manner, and the Parties shall negotiate in good faith with a view to agreeing upon one or more provisions which may be substituted for such invalid, unenforceable or illegal provisions, as nearly as is practicable.





Provided failure to agree upon any such provisions shall not be subject to dispute resolution under this Contract or otherwise.

#### **34.8 No Partnership**

Nothing contained in the Contract shall be construed or interpreted as constituting a partnership between the Parties. Neither Party shall have any authority to bind the other in any manner whatsoever. The Contract shall be construed to have been entered on a principal to principal basis.

#### **34.9 Exclusion of implied warranties**

This Contract expressly excludes any warranty, condition or other undertaking implied at law or by custom or otherwise arising out of any other agreement between the Parties or any representation by any Party not contained in a binding legal Contract executed by the Parties.

#### **34.10 Entire Agreement**

The Contract constitutes the entire agreement between the Parties and supersedes all prior negotiations, commitments, representations, communications and agreements relating to the Contract either oral or in writing except to the extent they are expressly incorporated herein. The Contractor confirms that it has not relied upon any representation inducing it to enter into the Contract (whether or not such representation has been incorporated as a term of the Contract) and agrees to waive any right which it might otherwise have to bring any action in respect of such representation. The Contractor further confirms that there is not in existence at the date of the Contract any collateral contract or warranty of which the Contractor is the beneficiary which might impose upon NATIS obligations which are in addition to or vary the obligations expressly contained in the Contract and which relate in any way to the subject matter of the Contract. The Contractor's only rights arising out of, or in connection with, any act, matter or thing said, written or done, or omitted to be said, written or done, by or on behalf of NATIS (or any agent, employee or subcontractor of NATIS) in negotiations leading up to the Contract or in the performance or purported performance of the Contract or otherwise in relation to the Contract are the rights to enforce the express obligations of NATIS contained in the Contract and to bring an action for breach thereof. Nothing in this **Clause 34.10 [Entire Agreement]** is intended to exclude liability of the Contractor for fraud or fraudulent misrepresentation.

#### **34.11 Liability and Indemnity**

34.11.1 The Contractor shall indemnify, defend and hold NATIS harmless against any and all proceedings, actions and third party claims arising out of a breach by the Contractor of any of its obligations under the Contract except to the extent that any such claim has arisen due to breach by NATIS of any of its obligations under the Contract.





- 34.11.2 NATIS will, indemnify, defend and hold harmless the Contractor against any and all proceedings, actions, third party claims for loss, damage and expense of whatever kind and nature arising out of breach by NATIS, its officers, servants and agents of any obligations of NATIS under the Contract except to the extent that any such claim has arisen due to breach by the Contractor of any of its obligations under the Contract.
- 34.11.3 In the event that either Party receives a claim from a third party in respect of which it is entitled to the benefit of an indemnity under the Contract (the "Indemnified Party") it shall notify the other Party ("Indemnifying Party") within [7 (seven)] days of receipt of the claim and shall not settle or pay the claim without the prior approval of the Indemnifying Party, provided that, such approval shall not be unreasonably withheld or delayed. In the event that the Indemnifying Party wishes to contest or dispute the claim it may conduct the proceedings in the name of the Indemnified Party subject to the Indemnified Party being secured against any costs involved to its reasonable satisfaction.
- 34.11.4 The Indemnified Party shall have the right, but not the obligation, to contest, defend and litigate any claim, action, suit or proceeding by any third party alleged or asserted against such party in respect of, resulting from, related to or arising out of any matter for which it is entitled to be indemnified hereunder and their reasonable costs and expenses shall be indemnified by the Indemnifying Party. If the Indemnifying Party acknowledges in writing its obligation to indemnify the person indemnified in respect of loss to the full extent provided by this **Clause 34.11.3 [Liability and Indemnity]**, the Indemnifying Party shall be entitled, at its option, to assume and control the defence of such claim, action, suit or other proceedings, liabilities, payments and obligations at its expense and through counsel of its choice provided it gives prompt notice of its intention to do so to the Indemnified Party and reimburses the Indemnified Party for the reasonable cost and expenses incurred by the Indemnified Party prior to the assumption by the Indemnifying Party of such defence. The Indemnifying Party shall not be entitled to settle or compromise any claim, action, suit or proceeding without the prior written consent of the Indemnified Party unless the Indemnifying Party provides such security to the Indemnified Party as shall be reasonably required by the Indemnified Party to secure, the loss to be indemnified hereunder to the extent so compromised or settled.
- 34.11.5 If the Indemnifying Party has exercised its rights under **Clause 34.11.3 [Liability and Indemnity]**, the Indemnified Party shall not be entitled to settle or compromise any claim, action, suit or proceeding without the prior written consent of the indemnifying Party (which consent shall not be unreasonably withheld or delayed).
- 34.11.6 If the Indemnifying Party exercises its rights under **Clause 34.11.3 [Liability and Indemnity]**, then the Indemnified Party shall nevertheless have the right to employ its own counsel and such counsel may participate in such action, but the fees and expenses of such counsel shall be at the expense of such Indemnified Party, when and as incurred, unless:

- (i) the employment of counsel by such party has been authorised in writing by the Indemnifying Party; or





- (ii) the Indemnified Party shall have reasonably concluded that there may be a conflict of interest between the Indemnifying Party and the Indemnified Party in the conduct of the defence of such action; or
- (iii) the Indemnifying Party shall not in fact have employed independent counsel reasonably satisfactory to the Indemnified Party to assume the defence of such action and shall have been so notified by the Indemnified Party; or
- (iv) the Indemnified Party shall have reasonably concluded and specifically notified the Indemnifying Party either:
  - (a) that there may be specific defences available to it which are different from or additional to those available to the Indemnifying Party; or
  - (b) that such claim, action, suit or proceeding involves or could have a Material Adverse Effect upon it beyond the scope of the Contract.

Provided that if **Clauses 34.11.6(ii) (iii) or (iv)** [Liability and Indemnity] shall be applicable, counsel for the Indemnified Party shall have the right to direct the defence of such claim, action, suit or proceeding on behalf of the Indemnified Party and the reasonable fees and disbursements of such counsel shall constitute legal or other expenses hereunder.

**35. Superstition of General Conditions of Contract**

Any clause/s contained in this General Conditions of Contract shall be superseded with the relevant clause/s in the Special Conditions of Contract.



**Section- 5 - SPECIAL CONDITIONS OF CONTRACT [SCC]**

5.1. The following clauses under this Special Conditions of Contract (SCC) complements to the corresponding clauses in the GCC. As per GCC, clause 1.5 (Priority of Documents), the SCC takes precedence over the GCC. Whenever there is a conflict, the provisions herein shall prevail over those in the GCC.

5.2. STATEMENTS TO COMPLEMENT THE GENERAL CONDITIONS OF CONTRACT

Sl. No	Conditions	Ref. to GCC	Statements
1	Amount of Recoverable advance Payments towards Mobilization of works/Materials.	1.1 & 26.11.1  26.11.2	Up to Ten (10) % of the Accepted Contract Price, with a simple interest rate of 10% per annum on the balance outstanding, against the BG of 110% of requisite advance amount, valid up to contract period/ up to recovery of full amount, whichever is earlier, shall be paid upon release of NTP and on request of the contractor.  i.e. "The mobilization advance shall not be paid in less than two instalments" as decided by NATRAX representative on specific request by the contractor. On each occasion of the release of mobilisation advance, Bank Guarantee equivalent to 110% of the advance so paid shall be furnished by the contractor for the period mentioned above.
2	The Default Interest Rate	1.1, 34.2	14% interest for the period, In case of non return of mobilization advance after stipulated due date.
3	The Defects Rectification Period, counted from the Date of completion of works (DoCW), as mentioned in the Completion certificate.	1.1	Six Months.
4	Guarantee Period for utility items (Counted from DoCW)	1.1	Deleted
5	<b>Latent Defect Rectification Period</b> , Counted from the next day after the date of Completion of Defects Rectification Period.	1.1	Deleted.

Sl. No	Conditions	Ref. to GCC	Statements
6	Liquidated Damages	1.1	0.1% of the final Contract Price per day. (Maximum up to 10 % of the Contract price)
7	Milestone Event	1.1	Deleted
8	Project site	1.1	National Automotive Test Tracks (NATRAX),NH-52, Old Agra- Mumbai Highway, Near to Pithampur Flyover, Post Khandwa (Near Pithampur) ,Dist. Dhar (M.P.)-454774
9	Provisional Sum	1.1	Nil
10	Provisional Sum Works	1.1	Nil
11	Time for Completion	1.1	<b>40 days</b> from the date of issue of Notice to Proceed for complete work.
12	Address for Communication	1.4.1 (ii)	National Automotive Test Tracks (NATRAX) NH-52, Old Agra-Mumbai Highway, Near to Pithampur Flyover, Post Khandwa (Near Pithampur, Dist. Dhar (M.P.).
13	Amount of Performance Guarantee	1.9.1	FIVE (5) % of the contract price.
14	Period of Performance Guarantee	1.9.1	Valid for 09 Months from the date of Issue of NTP
15	Date of return of the Performance Guarantee	1.9.6	The date within 30 days, after the date of issue of "Defect Rectification Certificate"
16	Percentage to be retained as Retention Amount	1.9.5	Ten (10) % of each Interim Payment Certificate (gross) limiting to five (5) % of the Gross certifiable amount. Retention Amount can be released on submission of equivalent amount of Bank Guarantee valid up to the period of settlement as per clause 1.9.5 of GCC.
17	Date of release of the Retention Amount	1.9.5 (ii)	The date 15 days after the date of issue of the completion certificate for the works.
18	Property in excavated material	5.5, 13.7& 29.2	Works shall be as directed by the Engineer In-charge/NATRAX. Any damage caused to the installations shall be repaired at contractor's cost.
19	Applicable Clearances that are NATRAX Responsibility	6.1.3 (iii)	<i>Only the statutory approvals in respect of NATRAX</i>



Sl. No	Conditions	Ref. to GCC	Statements
20	Claims	19A.1	No claims, including price variation etc. are permitted during the execution of works within the fixed completion period as mentioned in the Notice to proceed and also in the extended period in case the extension is granted.
22	Maximum Damages Liquidated	20.1	Maximum 10% of the final Contract Price.
23	Payment of Bonus	20.4	Nil
24	Variation of quantities	22.2.2 (ii) 23.4	<p>This tender is based upon the drawings enclosed with technical specifications and BOQ. NATRAX reserves the right to vary any individual item to any extent either positive or negative within the scope of work as defined. The decision as to items are within the scope of work shall be of NATRAX which is final &amp; binding.</p> <p>Therefore, in case of variation in quantity as given in BOQ either positive or negative no rate revision is applicable.</p>
25	Contractor's Changes	23.3.3	Nil
26	Valuation of Changes	23.5.1 (1)	New Rate or Price shall be derived from any relevant rates or prices in the Contract.
		23.5.1 (2)	<p>New rate or price shall be derived from the MP SOR for building work 2024 &amp; latest MPSOR for Road &amp; Bridges rates and MPSOR 2022 for Electrical Works(E&amp;M) which ever applicable. In case the rates are not available in MP SOR for building work 2024 &amp; latest MPSOR for Road &amp; Bridges rates and MPSOR 2022 for Electrical Works(E&amp;M) rates, the same shall be derived from the competitive market quotes, obtained by NATRAX representative.</p> <p>The contractor's profit and overheads together shall be taken as 10% only.</p>
		23.5.1 (3)	Rates or prices shall be those in the Contract of that particular omitted item of work.
27	Payment against materials stored at site.	26.3.3(ii)	Can be considered only against the actual cost of material as per invoice.
28	Mode of Payment	26.7	Through RTGS/NEFT
29	Currency of Payment	26.9	Indian Rupees Only.



Sl. No	Conditions	Ref. to GCC	Statements
30	Repayment of Recoverable advance amount towards Mobilization of works.	26.11.6	Repayment of Advance amount towards mobilization shall be made in 3 equal instalments, by way of A/c. Payee cheque/DD, payable at Pithampur, in favour of 'National Automotive Test Tracks' or by way of deduction from IPC as opted by contractor.
31	Taxes	27.1	The rates quoted by the contractor shall be deemed to be inclusive of the Goods and Service Tax (GST) and other levies, duties, royalties, cess, tax, toll taxes of central and state governments, local bodies and authorities that the contractor will have to pay for the performance of this contract. NATRAX will perform such duties in regard to the deduction of such taxes at source as per applicable law. The tax if any paid by the contractor shall not be reimbursed by NATRAX. And change in legislation will not applicable for reimbursement of tax.

#### SECTION-5.1-Milestones

*Deleted*

#### Section- 6.1- FORMAT OF ARTICLES OF AGREEMENT

CONTRACT AGREEMENT No.: Tender No. \_\_\_\_\_ , Dated-----  
.....the ..... 2026

THIS AGREEMENT is made on ..... between **National Automotive Test Tracks (NATRAX)**, a Unit of **National Automotive Board Society** having its registered office at 124, Udyog Bhawan, New Delhi - 110001 (hereinafter referred to as "the Employer" which expression shall include its successors and assigns), and whose principal place of business is at National Automotive Test Tracks (NATRAX), NH-52, Old Agra-Mumbai Highway, Near to Pithampur Flyover, Post Khandwa (Near Pithampur), Dist. Dhar (M.P.)-454774 , of the One Part,

AND

M/s. ...., having its registered office at ....., (Hereinafter referred to as "the Contractor"), of the Other Part:





**WHEREAS** the Employer invited bids through open tender, vide Invitation for Bids dated, 28<sup>th</sup> January 2026 “Providing/Casting RCC Dead Load Block(DLB) for testing Laden Vehicle(LCV&HCV)” at NATRAX- Pithampur- **Tender No.- NATRAX/PROC/PG-C&M/26/135**

**AND WHEREAS** the Employer has selected ....., as the successful bidder (“the Contractor”) pursuant to the bidding process and negotiation of contract prices, awarded the **Letter of Acceptance (LoA) No. ....**, to the Contractor on ..... for a total sum of ..... [Rupees ..... Only].

- I. **AND WHEREAS** the Employer desires that the Works (as defined in the Bidding Document) be implemented, performed, executed and completed by the Contractor, including the remedying of any defects therein and wishes to appoint the Contractor for carrying out such Works.
- II. **AND WHEREAS** the Contractor acknowledges that the Employer has entered into or will enter into other contracts with other contractors and/or parties for elements of the Project (as defined in the General Conditions of Contract) (and not comprised in the Works) and that the Employer will have Related Works performed and that it is of paramount importance that the Works are fully and completely co-ordinated by the contractor with the Related Works in view of their concurrent and sequential nature.
- III. **AND WHEREAS** the terms and conditions of this Contract have been fully negotiated between the Employer and the Contractor as parties of competent capacity and equal standing.

IV. The Employer and the Contractor agree as follows:

1. In this Agreement (including the recitals) capitalized words and expressions shall have the same meanings as are respectively assigned to them in the Contract documents referred to.

2. The following documents shall be deemed to form and be read and construed as part of this Agreement. This Agreement shall prevail over all other Contract documents.

The Letter of Acceptance (LoA) issued by NATRAX.

The complete Bid as submitted by the Contractor.

The Addenda issued by NATRAX.

Any other documents forming part of this Contract Agreement till date. (PBG, BGs, PoA etc.)

The negotiated Bill of Quantities.

Supplementary Agreements executed from time to time.

3. Any changes/modifications/amendments required to be incorporated in the Contract Agreement at a later stage shall be discussed and mutually agreed by both the parties and such supplementary agreements shall be binding on both the parties and shall form the part of this contract agreement.

4. The key personnel earmarked for this Project from NATRAX and Project Management Consultants shall be intimated to the contractor from time to time. The key personnel to be deployed for the project from the Contractor’s side shall be decided and mutually agreed from time to time.







## Section 6.2- Form of Sub contractor's Warranty

**THIS AGREEMENT** is made as a deed the                      day of                      2020.

### **BETWEEN**

[ •Insert name and address of Subcontractor ] (the "Subcontractor"); and

[ •NATRAXInsert address ] (the "Employer")

[•Insert name and address of Contractor under the Subcontract] (the "Contractor")

### **WHEREAS**

- A. By an agreement in writing dated [                      ] (the "**Contract**") the Contractor has entered into a contract with the Employer for the Works (as defined in the Contract.)
- B. Pursuant to the Contract, the Contractor has undertaken to procure a warranty from the Subcontractor, in favour of the Employer [and the Lenders].
- C. By agreement in writing made [•Insert date of Subcontract] (the "**Subcontract**") the Subcontractor agreed with the Contractor to construct the [Insert details of part of the Works for the subcontractor] (the "**Subcontract Works**").
- D. Pursuant to Clause [                      ] of the Subcontract, the Subcontractor is obliged to provide the Employer with a deed of warranty in the terms of this Agreement.

**NOW IN CONSIDERATION OF THE PAYMENT OF [INSERT NOMINAL FIGURE AND CURRENCY] BY THE EMPLOYER TO THE SUBCONTRACTOR** (receipt of which the Subcontractor hereby acknowledges) **IT IS HEREBY AGREED** as follows:

### **1. DEFINITIONS AND INTERPRETATION**

Capitalised terms where not defined in this Agreement shall have the meanings set out in the Contract or the Subcontract as appropriate.

The interpretation provisions of the Contract or the Subcontract (as appropriate) shall apply hereto as if expressly set out herein (mutatis mutandis).

Where the Subcontractor comprises a firm or partnership, the liability of the proprietors or partners of such firm or partnership shall be joint and several.

### **SUBCONTRACTOR'S WARRANTY**

The Subcontractor warrants and undertakes to the Employer that he has carried out and completed or will carry out and complete the Subcontract Works with due diligence, in accordance with and subject to the terms of the Subcontract, and has observed and performed and will observe and perform all of its duties and obligations expressed in or arising out of the Subcontract and has exercised and will exercise the standards of skill and care reasonably to be expected of a Subcontractor experienced in carrying out works of a similar size, scale and value to the Subcontract Works.

Without prejudice to or derogation from Clause 2.1 the Subcontractor warrants to the Employer that:





to the extent that under the Subcontract, the Subcontractor takes responsibility for the design/ execution of the Subcontract Works or part or parts thereof the Subcontractor warrants to the Employer that the same have been or will be designed or selected exercising the standard of skill and care reasonably to be expected of a Subcontractor experienced in carrying out works of a similar size, scale and value to the Subcontract Works;

to the extent that under the Subcontract, the Subcontractor takes any responsibility for the design/ execution of the Subcontract Works, the Subcontract Works have been and will continue to be designed and specified with due regard to the Background Information and will when completed, comply and be consistent with all legal, technical, performance, operational and health and safety requirements referred to in or to be reasonably inferred from the Technical Specifications and Drawings and the Contractor's bids or are reasonably foreseeable to be likely to come into force before Completion of the whole of the Works; and

materials which would reasonably be considered within the construction industry as deleterious and not to be used when adopting best industry practice will not be specified for use and will not be used and have not been specified or used in the Subcontract Works.

The Subcontractor acknowledges and agrees that the Employer shall be deemed to have relied and is entitled to rely upon the Subcontractor's skill and judgment in the design (to the extent undertaken by the Subcontractor) and the execution of the Subcontract Works.

## LIABILITY

The obligations of the Subcontractor under or in connection with this Agreement shall be in addition to and without prejudice to any other present or future liability of the Subcontractor to the Employer and the liability of the Subcontractor to the Employer shall not be released, diminished or in any other way affected by any act, either by or on behalf of the Employer.

No allowance of time by the Employer hereunder or by the Contractor under the Subcontract nor any forbearance of forgiveness in or in respect of any matter or thing concerning this Agreement or the Subcontract on the part of the Employer or the Contractor, nor anything that the Employer or the Contractor may do or omit or neglect to do, shall in any way release the Subcontractor from any liability under this Agreement.

The Subcontractor shall have no duties and obligations to the Employer which are greater than those it owes to the Contractor under the Subcontract.

## EXPIRY OF WARRANTY

No proceedings shall be commenced against the Subcontractor under this Agreement more than [*insert period from Subcontract*] after Completion of the Works under the Contract (or, if earlier, more than [*insert period from Subcontract*] after the employment of the Subcontractor under the Subcontract is terminated).

## "STEP-IN" PROVISIONS

The Subcontractor warrants to the Employer that it shall not exercise or seek to exercise any right which may be or becomes available to it to terminate its employment under the





Subcontract and shall not repudiate or abandon the Subcontract nor discontinue or suspend the performance of any duties or obligations thereunder, without first giving to the Employer not less than twenty-eight (28) days prior written notice of the Subcontractor's intention so to do, specifying the grounds for so doing.

If the Employer serves on the Subcontractor a notice in accordance with Clause 5.3, the Subcontractor shall not terminate its employment under the Subcontract nor treat the Subcontract as terminated, repudiated nor abandoned nor discontinue or suspend the performance of its duties thereunder.

Unless the employment of the Subcontractor under the Subcontract shall have been terminated previously (and whether or not the Subcontractor shall have served notice on the Employer pursuant to Clause 5.1), if the Employer serves upon the Subcontractor a notice so to do, the Subcontractor shall thereafter accept the instructions of the Employer or his Lenders to the exclusion of the Contractor under and in connection with the Subcontract.

As against the Contractor and the Employer, the Subcontractor shall be obliged and entitled to comply with and to rely upon any notice served by the Employer under relevant clauses, and shall not be obliged to make any enquiry as to the entitlement of the Employer to serve such notice as against the Contractor.

As from the date of service of notice under relevant clauses, the Employer or its nominee shall assume all the rights and perform all the obligations of the Contractor under the Subcontract, provided that this shall not affect or derogate from any right of action the Contractor may have against the Subcontractor in respect of any breach of duty of the Subcontractor under or in connection with the Subcontract occurring prior to the date of service of the notice by the Employer under relevant clauses.

Within twenty-one (21) days after serving notice under relevant clauses, the Employer shall pay to the Subcontractor an amount equal to all sums which are properly due and owing to the Subcontractor under the Subcontract provided that, in respect of sums due and payable up to and including the date on which the Subcontractor gives notice under relevant clauses /Clause 5.1, the liability of the Employer shall be limited to the sums so notified by the Subcontractor as at the date of such notice and the Subcontractor shall have no right of termination, repudiation, abandonment, suspension, set-off, withholding, counterclaim or claim in debt or of damages in respect of any sums due and payable as at the date of the Subcontractor's notice under relevant clauses /Clause 5.1, which were not notified thereunder. The Contractor acknowledges and agrees that any sum paid by the Employer to the Subcontractor under this relevant clauses /Clause 5.6 shall be recoverable from the Contractor.

If the employment of the Subcontractor under the Subcontract is terminated before service of any notice under relevant clauses /Clause 5.3, then if required so to do by notice served by the Employer not later than 2 (two) weeks after the date of such termination, the Subcontractor shall enter into a new contract with the Employer or its nominee on the same terms as the Subcontract but with such revisions as the Employer may reasonably require to reflect the altered circumstances. Forthwith upon the execution of such new contract, the Employer shall pay to the Subcontractor an amount equal to the sum (excluding cancellation costs) which, immediately before termination of the Subcontractor's employment, was properly owing to the Subcontractor by the Contractor under the





Subcontract and which remains unpaid provided that in respect of sums due and payable up to and including the date on which the Subcontractor gives notice pursuant to Clause 5.1, the liability of the Employer or its nominee shall be limited to the sums so notified by the Contractor as at the date of such notice and the Subcontractor shall have no right of termination, repudiation, abandonment, suspension, set-off, withholding, counterclaim or claim in debt or of damages in respect of any sums due and payable as at the date of the Subcontractor's notice under Clause 5.1, which were not notified thereunder. The Contractor acknowledges and agrees that any sum paid by the Employer to the Subcontractor under this Clause 5.7 shall be recoverable from the Contractor.

Upon payment by the Employer or its nominee in accordance with relevant clauses /Clause 5.6 or Clause 5.7 of an amount equal to the relevant sum owing from the Contractor, the Subcontractor shall assign and/or hereby assigns by way of future assignment to the Employer or its nominee all the Subcontractor's rights against the Contractor in respect of such unpaid sum, and shall account to the Employer or its nominee for any of the same subsequently received by it from the Contractor.

The Subcontractor hereby permits the Employer or its Lender to step into the Contract in place and substitution of the Contractor if the Contract is terminated in accordance with its terms.

The Employer guarantees to the Subcontractor the performance of the obligations of the Lenders of the Employer nominated under relevant clauses /Clause 5.3, Clause 5.7 or Clause 5.9.

The Contractor agrees to the foregoing provisions of this relevant clauses /Clause 5 and agrees to be bound by them.

#### **PROVISION OF FURTHER WARRANTIES**

The Subcontractor shall, as and when the Employer from time to time requires, promptly execute and deliver a deed or deeds of warranty in favour of any and all parties providing finance to the Employer for the Project in a form no more onerous than this Agreement as directed by the Employer.

If the Subcontractor fails to execute and deliver any such deed or deeds pursuant to Clause 6.1 within fourteen (14) days of the Employer's written request the Employer may execute such deed on the Subcontractor's behalf and the Subcontractor hereby appoints the Employer as the Subcontractor's attorney for the purposes of executing any such deed. The Subcontractor agrees to rectify and confirm any act done by the Employer pursuant to this power of attorney and agrees that this power is irrevocable.

#### **PROFESSIONAL INDEMNITY INSURANCE**

Any professional indemnity insurance in relation to the Subcontract Works shall be as provided in the Contract.

As and when reasonably required so to do, the Subcontractor shall provide the Employer with documentary evidence that the insurance required hereunder is in force and is being maintained.





## DESIGN PROGRAMME

The Subcontractor warrants to the Employer that it has supplied and shall supply any designs in accordance with any programme agreed or accepted by the Contractor or at such times as may reasonably be required so as not to delay or disrupt the Execution and completion of the Works.

## DESIGN LIFE

In relation to the Subcontract Works, the Subcontractor guarantees parts of the Subcontract Works each for the respective period set out in (Appendix ...) (the "Guarantee Period") in accordance with this relevant clauses /Clause 9. If during the Guarantee Period any defect, inadequacy or unsuitability of {design, manufacture, workmanship or materials – delete as applicable} or failure to meet in any or all respects the requirements of the Subcontract, shall arise or become apparent in the building works at Chennai or the rest of the Subcontract Works or any part thereof, written notice of such defect inadequacy or unsuitability, or failure shall be given by the Employer to the Subcontractor who shall promptly submit to the Employer for its approval its written proposals for the remedying of the same at no cost to the Employer. Upon receipt of the written approval of the Employer to the Subcontractor's proposal or any amendment thereof, the Subcontractor shall promptly, at a time convenient to the Employer implement its proposal as approved or amended with all due speed. If the Subcontractor shall fail to submit its written proposals within a time considered reasonable by the Employer or if such proposals are not, in the Employer's opinion satisfactory, the Employer may employ and pay other persons to carry out the necessary remedial work or carry out such work itself and the Subcontractor shall be liable for all costs in connection with such remedial work, for which the Employer may recover from the Subcontractor on demand.

The Employer's rights under this Clause 9 are without prejudice to any other right which it may have whether at law or otherwise.

## INTELLECTUAL PROPERTY

To the extent that the Subcontractor is the beneficial owner of rights in the Intellectual Property in the Subcontractor's Documents, the Subcontractor grants to the Employer an irrevocable, non-exclusive, royalty-free licence (including the right to sub-licence) to copy, use and communicate the Subcontractor's Documents and Intellectual Property contained therein in connection with or relating to the Subcontract Works or the Works and any Subcontractor Documents for any purpose whatsoever in connection with the Project and the development of the Works. The licence hereby granted may be transferred and/or sub-licensed by the Employer (and any transferee and/or sub-licensee of the Employer) to third parties on the same terms as here written.

Where the Subcontractor is not the beneficial owner of the rights to the Intellectual Property in the Subcontractor Documents to be licensed pursuant to relevant clauses /Clause 10.1 and in particular but without limitation the copyright in the source code in any system or software in the Subcontractor Documents designed and/or specified or prepared or created or utilised by the Subcontractor as part of the Subcontract Works or in connection with the Project the Subcontractor will procure a licence of such Intellectual Property for the benefit of the Employer on the same terms as set out in relevant clauses /Clause 10.1.





The Subcontractor warrants that there is and will be no infringement of any rights to Intellectual Property, in respect of the rights granted, assigned and/or transferred to the Employer pursuant to this relevant clauses /Clause 10. In the event that a third party infringes the Subcontractor's rights in relation to the Subcontractor Documents the Subcontractor hereby undertakes, if the Employer so requests, to take such action and institute such proceedings as may be appropriate to ensure that the Employer's rights are upheld and respected and the Employer's interests therein are not in any way prejudiced.

The Subcontractor shall be liable for and shall indemnify the Employer against any and all expenses, liabilities, losses, claims or proceedings the Employer may incur in the event:

that any of the rights granted by the Subcontractor pursuant to this relevant clauses /Clause 10 are found to be invalid, ineffective or impaired in any way; and/or

of any claim by any third party (whether upheld or not) that the exercise of the rights granted by the Subcontractor pursuant to this relevant clauses /Clause 10 infringe the rights of such third party.

**ASSIGNMENT**

The Employer shall be permitted to assign the entire benefit of this Agreement to the Lenders and the Lenders shall have the right to further assign such benefit of this Agreement without the prior written consent of the Subcontractor.

The Subcontractor shall not assign or purport to assign the benefit of this Agreement without the prior written consent of the Employer.

**EXTRANEOUS RIGHTS**

This Agreement shall not negate nor diminish any duty, obligation or liability otherwise than owed by the Subcontractor to the Employer or (save by operation of relevant clauses /Clause 5) to the Contractor.

**PRIVITY OF CONTRACT**

This Agreement is intended to be for the sole benefit of the Parties. The terms, conditions and/or other provisions of this Agreement which make reference to third parties are not intended to confer benefits and are not to be construed as conferring benefits upon such third parties. It is not the intention of the Parties that any term or condition of this Agreement should be enforceable by any person other than the Parties.

**NOTICES**

Save as otherwise agreed, all notices and other communications required in connection with this Agreement shall be in writing and sent by hand, by first class pre-paid post or by facsimile transmission to the designated persons at the addresses and/or facsimile numbers set out in this Clause 14.1 or to such other persons at such addresses and/or facsimile numbers as either Party may notify to the other in writing:



<b>Employer</b>	.....
-----------------	-------



[Address]	.....
	.....
[Fax]:	.....
[Attention]:	.....
<b>Subcontractor</b>	.....
[Address]:	.....
	.....
[Fax]:	.....
[Attention]:	.....
<b>Contractor</b>	.....
[Address]:	.....
	.....
[Fax]:	.....
[Attention]:	.....





Subject to Clause 14.3:

a notice or other communication delivered by hand shall be deemed to have been served on the date on which it is delivered to the designated addressee;

a notice or other communication sent by first class pre-paid post shall be deemed to have been served on the second Business Day after it has been put in the post to the designated addressee: and

a notice or other communication sent by facsimile transmission shall be deemed to have been served on the date on which the transmission was completed to the designated addressee.

A notice or other communication which is received by the designated addressee on a day which is not a Business Day or after 5 p.m. on a Business Day shall be deemed to have been served on the next Business Day.

#### **WAIVER**

Failure by a Party at any time to enforce any provision of this Agreement against the others shall not be construed as a waiver of such entitlement and shall not affect the validity of this Agreement or any part or parts hereof or the right of the relevant Party to enforce any provision in accordance of its terms. The rights and/or remedies of a Party may only be waived by formal written waiver which is signed by duly authorised representative of the Party waiving its rights and which makes express and unequivocal reference to the waiver being made pursuant to this Clause 15.

#### **COUNTERPARTS**

This Agreement may be executed in one or more counterparts. Any single counterpart or set of counterparts executed by the Parties shall constitute the full and original Agreement for all purposes.

#### **SEVERABILITY**

If any term or condition of this Agreement is for any reason held to be illegal, invalid, ineffective, inoperable or otherwise unenforceable, it shall be severed and deemed to be deleted from this Agreement and the validity and enforceability of the remainder of this Agreement shall not be affected or impaired thereby.

#### **GOVERNING LAW AND JURISDICTION**

This Agreement shall be governed by and construed in accordance with the laws of the India.

Save where expressly stated to the contrary in the Contract, any dispute shall be finally settled by binding arbitration under the Arbitration and Conciliation Act 1996 Act and in accordance with the UNCITRAL arbitration rules.

**IN WITNESS** whereof the Parties have executed and delivered this Agreement as a Deed the day and year first before written.





**Execution by the Subcontractor**

Executed and delivered as )  
a Deed by [● *the Subcontractor* ] )  
acting by two directors or by a )  
director and the company ) .....

Director

.....  
Director/Company Secretary

**Execution by the Employer**

Executed and delivered as )  
a Deed by [● *the Employer* ] )  
acting by two directors or by a )  
director and the company )  
secretary in the presence of: ) .....

Director

.....  
Director/Company Secretary

**Execution by the Contractor**

Executed and delivered as )  
a Deed by [● *the Contractor* ] acting )  
by two directors or by a director )  
and the company secretary )  
in the presence of: ) .....

Director





.....  
Director/Company Secretary

**SECTION 6.3- PERFORMANCE BANK GUARANTEE**

**(TO BE EXECUTED ON NON-JUDICIAL STAMPED PAPER OF AN APPROPRIATE VALUE)**

National Automotive Test Tracks (NATRAX),  
NH-52, Old Agra- Mumbai Highway,  
Near to Pithampur Flyover,  
Post Khandwa (Near Pithampur),  
Dist. Dhar (M.P.)-454774

Date : .....

Bank Guarantee No : .....  
Amount of Guarantee : .....  
Guarantee Period : From ..... to.....  
Guarantee Expiry Date : .....  
Last date of Lodgement : .....

**WHEREAS** National Automotive Test Tracks (NATRAX), having its corporate office at NBCC Place, 3<sup>rd</sup> Floor, South Tower, Bhishma Pitamah Marg, Pragati Vihar, Lodhi Road, New Delhi-110003 and site office at NH-52, Old Agra- Mumbai Highway, Near to Pithampur Flyover, Post Khandwa (Near Pithampur), Dist. Dhar (M.P.)-454774. "**The Owner**" which expression shall unless repugnant to the context includes their legal representatives, successors and assigns) and having their registered office at 124, Udyog Bhawan, New Delhi - 110011, has executed a binding to the contract on [Please insert date of acceptance of the letter of acceptance(LoA)] ("**Contract**") with [insert name of the Successful Bidder] .....(hereinafter referred to as the "**Contractor**" which expression shall unless repugnant to the context include its legal representatives, successors and permitted assigns) for the performance, execution and implementation of the Works ("**Works**" shall have the meaning ascribed to it in the Contract] based on the terms & conditions set out in the Tender Documents number [insert reference number of the Tender Documents] dated [insert date of issue of Tender Documents].....and various other documents forming part thereof.

**AND WHEREAS** one of the conditions of the Contract is that the Contractor shall furnish to the Owner a Bank Guarantee from a scheduled bank in India having a branch at Pithampur for an amount equal to 5% (five percent) of the total Contract Sum (the amount guaranteed under this bank guarantee shall hereinafter be referred to as the "**Guaranteed Amount**") against due and faithful performance of the Contract from the post-commissioning stage of the Works under the Contract, including the performance bank guarantee obligation and other obligations of the Contractor for the supplies made and the Works being performed and executed by under the Contract. This bank guarantee shall be valid from the date hereof up to the expiry of the Warranty Period including any extension thereof.

**AND WHEREAS** the Contractor has approached [insert the name of the scheduled bank] (here in after referred to as the "**Bank**") having its registered office at [insert the address].....and at the request of the





Contractor and in consideration of the promises made by the Contractor, the Bank has agreed to give such guarantee as hereunder:-

- (i) The Bank hereby undertakes to pay under this guarantee, the Guaranteed Amount claimed by the Owner without any further proof or conditions and without demur, reservation, contest, recourse or protest and without any enquiry or notification to the Contractor merely on a demand in the form set out in Appendix I ("Demand") from the Owner stating that the amount claimed is due to the Owner under the Contract. Any such demand made on the Bank by the Owner shall be conclusive as regards the amount due and payable by the Bank under this bank guarantee and the Bank shall pay without any deductions or set-offs or counterclaims whatsoever, the total sum claimed by the Owner in such Demand. The Owner shall have the right to make an unlimited number of Demands under this bank guarantee provided that the aggregate of all sums paid to the Owner by the Bank under this bank guarantee shall not exceed the Guaranteed Amount. In each case of demand, resulting to change of PGB values, the Owner shall surrender the current PGB to the bank for amendment in price.
- (ii) However, the Bank's liability under this bank guarantee shall be restricted to an amount not exceeding [figure of Guaranteed Amount to be inserted here].....  
...only).
- (iii) The Owner will have the full liberty without reference to the Bank and without affecting the bank guarantee to postpone for any time or from time to time the exercise of any powers and rights conferred on the Owner under the Contract and to enforce or to forbear endorsing any powers or rights or by reasons of time being given to the Contractor which under law relating the Surety would but for the provisions have the effect of releasing the surety.
- (iv) The rights of the Owner to recover the Guaranteed Amount from the Bank in the manner aforesaid will not be affected or suspended by reasons of the fact that any dispute or disputes have been raised by the Contractor and / or that any dispute(s) are pending before any office, tribunal or court in respect of such Guaranteed Amount and/ or the Contract.
- (v) The guarantee herein contained shall not be affected by the liquidation or winding up, dissolution, change of constitution or insolvency of the Contractor but shall in all respects and for all purposes be binding and operative until payment of all money due to the Owner in respect of such liability or liabilities is effected.
- (vi) This bank guarantee shall be governed by and construed in accordance with the laws of the Republic of India and the parties to this bank guarantee hereby submit to the jurisdiction of the Courts of Madhya Pradesh for the purposes of settling any disputes or differences which may arise out of or in connection with this bank guarantee and for the purposes of enforcement under this bank guarantee.
- (vii) All capitalized words used but not defined herein shall have the meanings assigned to them under the Contract.





**(VIII) NOTWITHSTANDING ANYTHING STATED ABOVE, THE LIABILITY OF THE BANK UNDER THIS BANK GUARANTEE IS RESTRICTED TO THE GUARANTEED AMOUNT AND THIS BANK GUARANTEE SHALL EXPIRE ON THE EXPIRY OF THE WARRANTY PERIOD UNDER THE CONTRACT.**

- (ix) Unless a Demand under this bank guarantee is filed against the Bank within six (6) months from the date of expiry of this bank guarantee all the rights of the Owner under this bank guarantee shall be forfeited and the Bank shall be relieved and discharged from all liabilities hereunder.
- (x) However, in the opinion of NATRAX, if the Contractor's obligations against which this bank guarantee is given are not completed or fully performed by the Contractor within the period prescribed under the Contract, on request of the Contractor, the Bank hereby agrees to further extend the bank guarantee, till the Contractor fulfils its obligations under the Contract.
- (xi) We have the power to issue this bank guarantee in your favour under Memorandum and Article of Association and the Undersigned has full power to do so under the Power of Attorney dated [*date of power of attorney to be inserted*].....granted to him by the Bank.

Date:

Bank

Corporate Seal of the Bank

By its constituted Attorney Signature of a person duly authorized to sign on behalf of the Bank.



Appendix-I



**FORM OF DEMAND**

[To the issuing Bank]

Dear Sirs

The Contract between National Automotive Test Tracks (NATRAX) and [*Please insert the name of the Successful Bidder*]

Bank Guarantee No. \*\*\*\*\* (“the Bank Guarantee”)

We refer to the above Contract and Bank Guarantee. Terms defined in the Bank Guarantee shall have the same meaning when used herein.

In accordance with the terms of the Bank Guarantee, we require payment by you of the sum of Rs. [\*\*\*\*\*] (\*\*\* Rupees) to the following account:

Account Number: [ ] with [ ] Bank, [ ] Branch, Sort Code [ ].

Yours sincerely,

[Signed by
[ ]
for and on behalf of
NATRAX



**Section 7.1- FORM FOR FINANCIAL CAPACITY**



**FINANCIAL DATA IN INR**

*Financial Capacity: Should have the Average Annual Financial turnover of at least Rs.25 Lakhs. in the last 3 financial years ((2022-23, 2023-24, 2024-25), ). Relevant proof for supporting the above shall be submitted or certificate from CA will be require..*

Financial Years	2022-2023	2023-2024	2024-2025
cumulative Construction Turnover			
Net Worth			
Current Assets			
Current Liabilities			
Total Revenues			
Profits Before Taxes			
Profits After Taxes			

- Bidder shall fill the financial data and attach copies of financial statements (balance sheets including all related notes, and income statements) for the last three years and current financial year, as indicated above, complying with the following conditions.
  - o All such documents reflect the financial situation of the Bidder and not sister or parent companies.
  - o Historic financial statements must be audited by a chartered accountant.  
Historic financial statements for the last F.Y is not computed; unaudited figures may be furnished. In case of becoming successful bidder, they may submit the audited statements before award of works.



**Section 7.2- List of Equipment (Minimum Requirement as and when required)**



1) Whereas it is entirely the responsibility of the Contractor to deploy sufficient machineries and mechanical equipment to ensure compliance with his obligations under the Contract, the list hereunder is included for information. This list constitutes the Employer's estimate of the minimum essential basic holding of plant and mechanical equipment which the Contractor will require in order to meet all of his performance obligations under this Contract.

Sr. No.	Name/Type of Equipment	Max. age (in Years)	Nos.
1	Manual Weigh Batcher	7-8	01
2	Mixer machine	7-8	01
3	Tractor	7-8	01
4	Tractor mounted Pile drilling Machine	5-7	01
5	Welding/ drilling machine	5-7	01
6	Tools & Tackles for fitting of accessory	5-7	01



**Section 7.3- Personnel Capabilities**



1) The Bidder shall supply general information on the management structure of the firm and shall make provision for suitably qualified personnel to fill the key positions as required during contract implementation and as suggested in Section.

#### MINIMUM KEY PERSONNEL FOR THE PROJECT

Whereas it is entirely the responsibility of the contractor to deploy sufficient Key Personnel at his office and at the site to ensure compliance with his obligations under the Contract. The list hereunder constitutes the Employer's assessment of minimum key site personnel requirements and is issued for information only.

Sr. No.	Personnel	Qualification/ Experience	Nos.
1	Site Engineer	Diploma in Civil Engineering 5 years Exp.	01
2	Site Supervisor	Experience in Civil Engineering work with + 3 years Exp.	01





#### Section 7.4- FORM FOR TECHNICAL CAPABILITY

(Refer the Minimum Eligibility Criteria at 2 (iii) of the ITB)

Here the Bidder shall fill the details of the "Providing/Casting RCC Dead Load Block(DLB) for Testing Laden Vehicle(LCV&HCV)"at Natrax-Pithampur" in the last 7 years meeting the following criteria.

- (a) Three similar completed works, costing not less than the amount equal to 40% of the estimated cost of each work.  
(OR)
- (b) Two similar completed works, costing not less than the amount equal to 50% of the estimated cost of each work.  
(OR)
- (c) One similar completed works costing, not less than the amount equal to 80% of the estimated cost.

For the purpose of assessment of technical capability, the latest cutoff date of work is 30 days prior to last date of submission of Bid Document.

**\*Similar work:** *Successful completion of Civil Engineering works for buildings/roads/test tracks/fencing works/fabrication works/RCC road and allied work for testing building/track/Road for any Government Department/Reputed firm/Private Institute/Academic Institute etc.*





**Section 8- CONTACT DETAILS FORM**

**BIDDERS ARE REQUESTED TO SUBMIT THE FOLLOWING DETAILS WITHIN 7 DAYS FROM THE DATE OF PURCHASE OF TENDER DOCUMENTS**

the "Providing/Casting RCC Dead Load Block(DLB) for Testing Laden Vehicle(LCV&HCV)"at Natrax-Pithampur" at Natrax-Pithampur".

**Tender No:NATRAX/PROC/PG-C&M/26/135**

**GENERAL DETAILS OF BIDDER**

- 1. NAME OF THE COMPANY : .....
- 2. COMMUNICATION ADDRESS : .....
- 3. PHONE NO. : .....
- 4. FAX NO. : .....
- 5. E-Mail ID. : .....

**PARTICULAR DETAILS OF THE BIDDER'S REPRESENTATIVE**

- 6. NAME OF THE CONTACT PERSON .....
- 7. DESIGNATION : .....
- 8. PHONE NO. (DIRECT) : .....
- 9. MOBILE NO. : .....
- 10. E-MAIL ID : .....
- 11. NAME OF THE ALTERNATE  
CONTACT PERSON : .....
- 12. E-MAIL ID : .....

Signature of the  
Authorized Signatory

**NOTE: You are requested to check the E-mail IDs given by you regularly for the incoming mails form NATIS.**





**Section-9- Checklist**

Sl. No	GENERAL	YES/NO
1	Have you send the contact details form to NATRAX?	
2	Have you read and understood various conditions of contracts like ITB,GCC, SCC,TCC (Technical specifications, drawings) and all other contractual requirements ?	
	<b>TECHNICAL BID</b>	
3	Have you enclosed the EMD for Rs. 18,000/- in the technical Bid?	
4	Have you taken prints of all the sections of tender, including addenda, in the prescribed paper size and signed on all the pages of the tender documents?	
5	Have you attached proof for having met the following minimum eligibility criteria?	
5.1	<i>legally valid entity: Certificates issued by registrar of firms/companies</i>	
5.2	<i>Financial Capacity of last 3 financial years</i>	
5.3	<i>Technical Capability: Certificates issued by govt. Depts/ Autonomous bodies/ PSUs/Reputed Private Firms (only). TDS certificate/C.A's certificate incase required</i>	
6	Have you attached the proof of authorisation to sign on behalf of the bidder in the technical Bid?	
7	Have your technical bid been prepared for packing as per Tender?	
	<b>FINANCIAL BID</b>	
8	Have your financial Bid proposal is duly filled, sealed and signed on all pages?	
9	Have you filled your quotes against all items?	
10	Have you verified the calculation of prices?	
11	Have your financial bid been properly packed as per Tender?	





**NATIONAL AUTOMOTIVE TEST TRACKS**

**TENDER DOCUMENTS**

"Providing/Casting RCC Dead Load Block(DLB) for Testing Laden Vehicle(LCV&HCV)" at Natrax-Pithampur

**Tender No: NATRAX/PROC/PG-C&M/26/135**

**Cover Page- Technical Conditions of Contract (TCC)**

The Technical Conditions of Contract contains the following Sections:

Section 10.1	-	Technical Specifications Civil Works
Section 10.2	-	Technical Specifications Electrical Works
Section 10.3	-	Technical Specifications Plumbing Works
Section 11	-	Drawings
Section 12	-	Forms for Technical & Commercial Queries

**National Automotive Test Tracks (NATRAX)**

NH-52, Old Agra- Mumbai Highway, Near to Pithampur Flyover, Post Khandwa (Near Pithampur)

Dhar District, Madhya Pradesh-454774

Phone: +919893892310, Fax – 07292-256101





## Section 10.1 - Technical Specifications [Civil Works]

Name of work: - Providing/Casting RCC Dead Load Block(DLB) for testing Laden vehicle(LCV&HCV) at NATRAX, Pithampur, Dhar (MP)

### 1. Minimum Evaluation Criteria:

i. **Legal Valid Entity:** the bidder should be a legal valid entity, in support the documentary evidence should be uploaded in technical bid.

ii. **Financial capability:** bidder should have minimum 25 Lakhs average annual turnover during the last 3 fy (22-23,2023-24&2024-25) in support copy of audited balance sheet OR CA certificate ate with UDIN Number in both cases, in technical bid.

### 2. Minimum eligibility Criteria (MEC) technical parameters: Technical Capability.

**Experience:** it should have minimum 7 years' experience in Similar works\* - successfully completed Works pertaining any of following:

a. Three similar completed works costing not less than the amount equal to 40 (forty) percent of the estimated cost.

b. Two similar completed works costing not less than the amount equal to 50 (fifty) percent of the estimated cost.

c. One similar completed work costing not less than the amount equal to 80 (eighty) percent of the estimated cost.

**Similar Works\*:** successful completion Civil Engineering works for buildings/roads/test tracks/fencing works/fabrication works/RCC road and allied work for testing Building/Track/Road for any Govt Dept., /Reputed firm/Private Institution/Academic Institutions/etc.

-Completion certificate along with PO/ work order, with value of works, etc., or

-In-case completion certificate/Purchase order (PO) does not clearly mention the value of work executed, then the Bidder shall submit the fresh summary & proof as TDS, CA certificate, Excise, GST returns etc.,

-Incase PO/Work order/completion certificate issued by any private employer, then form 26AS should be submitted to support the genuineness of the same

vii. **Warranty period:** 1 year from the date of installation at site and acceptance by NATRAX

viii. **Vender should be taking approval of drawing and specific size of weight.**

### Scope Of work: (For RCC Dead Weight Block)

**Items Details- "RCC Weight Block":** - Manufactured box frame with steel structure & GI sheet outer wall, Reinforcement 10mm to 12mm Dia bar Jali top bottom, concrete mix M-40 mixing with steel fiver 8Kg/cum, two 19mm dia SS bar U-shape for hinging of RCC block All size should be as per given size & drawing.



## **10.20 TECHNICAL SPECIFICATIONS UTILITY WORKS**

### **1.EARTH WORKS**

#### **SITE PREPARATION**

##### **1.1 Site Investigation**

The contractor shall carefully examine the site and make all inspections necessary in order to determine the full extent of the work required making the completed work conform to the drawings and specifications. The contractor shall satisfy himself as to the nature and location of the work, conditions, the conformation and condition of the existing ground surface, and the character of the existing ground surface.

##### **1.2 Site Clearance**

The site shall be cleared of rubbish / debris of all kinds, loose rocks, small trees, not exceeding 30 cm in girth (measured at one meter above ground level), shrubs, stumps, grass, brush wood, undergrowth and any other vegetation, superficial earth etc.as directed by the Engineer-in-Charge. The site clearance shall be done twenty meters around the periphery of the proposed construction. Such site clearance shall be done in advance of the earth work and excavation operations and shall not be paid for. All materials arising from site clearance shall be the property of the Corporation and shall be disposed off by the Contractor at his own cost, as herein provided. All serviceable materials shall be temporarily stacked in separate lots at the site, at places as directed by the Engineer-in-Charge.

##### **1.3 Site Grading**

The levels and measurement of the existing site, as shown on the drawings are believed to be correct but the contractor shall verify them and also examine the nature of the ground as no claim or allowance whatever will be entertained thereafter on account of any errors or omissions in the levels of the description of the ground turning out different from that expected or shown on the drawings. Existing surface, after removal of all unwanted and unsuitable material shall be graded to the levels and slopes indicated in the contract drawings. Such grades and levels shall facilitate the intent of design

##### **1.4 Existing utilities**

Where existing utilities are encountered and found to interfere with the construction activity in this contract, they shall be removed if not required to be maintained or relocated to avoid interference or protected, supported and maintained during the construction phase, the exact dependent on the instruction of the Engineer.

##### **1.5 Disposal**

All rubbish and unwanted materials including unusable soil as they accumulate from time to time during the progress of the works and at completion including that of subcontractors shall be cleared and carted away and all materials condemned by the Engineer are to be removed from the works, within forty eight hours.

##### **1.6 Classification of soils**

All materials encountered in excavation will be classified in the following groups irrespective of mode of excavating the materials and the decisions of the Engineer-in-Charge in this regard shall be final and binding to the contractor.

###### **Classification of Soils**

**1.6.1 Ordinary Soil** - Generally any material which yields to the ordinary application of shovel like turf, sand, loam, soft shale, mixture of sand & clay or any mixture of these soils.

**1.6.2 Hard Soil** - Material requiring the application of pick such as stiff clays mixed with moorum etc.

**Soil Mixed with Boulders** - This shall consists of moorum, gravel or hard clay intercepted with boulders not larger than 30 cm cube which in the opinion of Engineer-in-charge do not require blasting and which shall be removed by iron, bars and shovel.

**1.6.7 Black Cotton Soil**- Black Cotton Soil is dangerous for buildings on accounts of its volumetric changes with the change of atmospheric conditions. It swells excessively when wet and shrinks excessively when dry. This soil has a great affinity for water. The differential settlement of the





structure, caused by the moment of ground on account of alternate swelling and shrinkage, results in formation of cracks. The cracks thus formed are some times 15 to 20 cm. wide and 2.5 to 4 m deep.

## **1.2. EXCAVATION**

The contractor shall notify the Engineer-in-charge before starting excavation and before the ground is disturbed, to enable him to take existing level for the purpose of measurements. The ground levels shall be taken at 5 to 15 metres intervals in uniformly sloping ground/Natural Ground and at distance where local mounds, pits, or undulations are met with, as directed by the Engineer-in-charge. The ground levels shall be recorded in field books and plotted on plans, which shall be signed by the Contractor and the Engineer-in-charge, before the earthwork is actually started and a copy of the same shall be submitted to NATRAX. be described as excavation over areas. Excavation exceeding 1.5m in width as well as 10sqm. on plan but not exceeding 30cm. in depth shall be described as surface Excavation.

### **1.2.1 Execution**

The excavation for basements, foundations, footings, trenches, pavings, walkways, etc shall be carefully got out to net width and depth as shown on the drawings. "Battering" or "Benching" to the sides of excavation shall have the prior approval of the Engineer. Extra excavation (i.e. excavation beyond the limits required by the drawings), carried out without prior approval of the Engineer will not be measured and such extra excavation will be filled in at the contractor's expenses with concrete (mix specified by the Engineer) well rammed in position and brought upto the required level. Any water that may accumulate in the excavation, due to any cause, is to be bailed or pumped out. Adequate pumping or other facilities shall be employed to keep all the excavations clear of water constantly, glare any damage to buildings or other property or cause inconvenience in the property. The contractor shall take care to avoid damage to water mains or other underground utilities pipes cables, etc. during excavation work; when met with during excavation, they should be properly supported. level.

### **1.2.2 Excavation in all sorts of soils & murrum**

The item shall include dry or wet excavation and removal of excavated material and its stacking and disposal in a manner hereinafter specified. The water met with if any shall be bailed or pumped out by the contractor as necessary at his own cost. The contractor shall provide all materials and all labour necessary for the excavation and completion of the works in accordance with the drawings and specifications and the intent there of. The contractor shall provide necessary protection to labour, materials equipment etc. to ensure safety against risk and accident. The ISI standard in this regard shall be followed (IS : 3764-1966). The contractor shall be liable to pay compensation for injury to life, and damage to property, if any,

### **1.2.9 Surplus Excavated Material**

The Contractor shall be responsible for making all arrangements for the disposal of surplus excavated material arising on any part of the Site to the place as directed by the EIC

### **1.2.10 Fencing / lighting**

The contractor shall make all proper provisions for protecting the work by fencing and by watching and lighting at night, or otherwise as may be directed by the Engineer-in-Charge. In the event of contractor not fully complying with the provisions of fencing, lighting, watching the Engineer may with or without notice to the contractor put up a fence, improve the lighting and adopt such other measures as he may deem necessary for the safety and all costs of such works including penalty to the contractor. The contractor shall also provide and display special boards painted with fluorescent paints indicating the progress of the work.

all be reinforced on concealed faces as necessary to support the service loads required. Aluminium shall be isolated from dissimilar metals, concrete, masonry and plaster to prevent electrolytic deterioration.

## **5.3 Common Bolts**

Bolts and nuts shall conform to IS:1363-1967. The bolts exposed to liquid surfaces shall be of Stainless Steel or Brass.

## **5.4 Welding Electrodes**

The electrodes shall conform to the requirements of IS:814 latest edition.

## **16 FENCING WORK WITH BARBED WIRE, CHAIN LINK ETC.**



The work shall generally be carried out as per these specifications, relevant drawings and as directed by the Engineer-in-charge.

**16.1 M.S. Posts and Struts :**

All the M.S. posts / struts shall be free from rust, scale, cracks, twists and other defects and shall be fabricated to the required shape and size out of the specified sections. The posts and struts shall be conforming to relevant specifications stipulated hereinbefore under relevant sections. All the posts and struts shall be of sizes and lengths as specified in the tender schedule. The exposed surfaces of the posts and struts shall be painted with two coats of approved primer.

**16.2 R.C.C Posts and Struts :**

All the posts and struts shall be of standard size as specified in schedule. These shall be coated on suitable places/platforms in cement concrete 1:2:4 (1 cement : 2 coarse sand : 4 graded stone aggregate 12.5 mm. nominal size) as per relevant specifications stipulated hereinbefore. The reinforcement shall be provided as hereinbefore under relevant sections. To posts and struts shall be free from honeycombing, cracks and other defects. After casting, the posts / struts shall be left at the same place and cured for a minimum period of 7 days. After 7 days curing the same shall be shifted to a leveled ground and stacked for further curing for 14 days. After 21 days of curing only, the posts/ struts shall be transported to work site without any damage, for fixing in position.

**16.3 Spacing of the Posts and Struts :**

The spacing of posts shall be as directed by the Engineer-in-charge, to suit the dimensions of the area to be fenced. Every 10<sup>th</sup> posts, last but one end posts, corner posts, and posts where the level of fencing changes in steps and end post when the fencing changes its direction shall be strutted on both sides or as directed by the Engineer-in-charges. End posts where barbed wire fencing is discontinued shall be strutted on one side only.

**18.4 Fixing of M.S. / R.C.C. Posts and Struts :**

Pits of size mentioned in the drawings, shall first be excavated centrally in the direction of proposed fencing work, true to line and level to receive the posts. In case of struts, the pits shall be so excavated, as to receive minimum 15cm. concrete cover at any point of the struts to suit its inclination or as shown in the drawing. The pits shall be filled with a layer of 15cm. thick cement concrete of specified mix. The posts and struts shall then be placed in the pits, the posts projecting to the specified height above ground level, true to line, plumb and position, by providing adequate supports temporarily, and cement concrete of specified mix, shall then be filled in so that the posts are embedded in cement concrete blocks of specified sizes. The concrete in foundation shall be watered for at least 7 days to ensure proper curing.

**List of makes/vendors:**

The list of vendors is given below for reference purpose only and the bidder may choose any other vendor as appropriate. In all the cases, the successful bidder shall have to take prior approval of NATRAX for such items listed below and its vendors.

Sl. No.	Description of Items	Name of Vendor
1	Cement: OPC 43 Grade:	ACC, Birla, Ultratech, Dalmia, Ambuja, Birla, JK Cement
2	Reinforcement Steel: Fe-500, TMT/HYSD	SAIL, TISCO, RINL, ISSCO, MOIRA
3	Structural Steel: IS-226, 2062 Grade-A/B	SAIL, TISCO, RINL, ISSCO, ZINDAL, Madhanchal steel



Section 11-Drawings

**RCC CONCRETE WEIGHT BLOCK**

SPECIFICATION OF BLOCK;

- CONCRETE M-40 MIX
- REINFORCEMENT STEEL FIBER
- STRUCTURAL STEEL OUTER FRAM

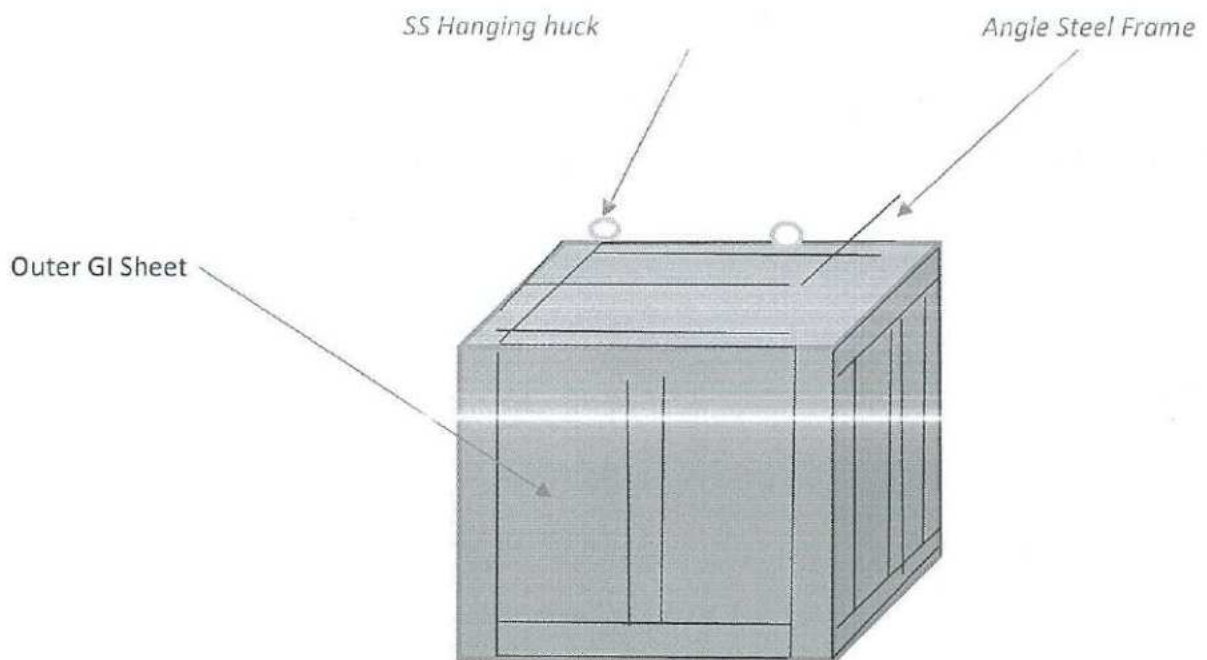



Section 12 -Forms for Technical & Commercial Queries

TECHNICAL QUERIES				
Pertaining to Tender No. -----				
Sr. No.	Reference to the Tender Document	Subject	Query	Clarifications of NATRAX

COMMERCIAL				QUERIES
Pertaining to Tender No. -----				
Sr. No.	Reference to the Tender Document	Subject	Query	Clarifications of NATRAX





**SECTION 13- FINANCIAL PROPOSAL SUBMISSION FORM**

(To be Executed on Letterhead of the Bidder)

*FINANCIAL PROPOSAL SUBMISSION FORM*

[Location, Date]

To: The Head- Procurement & stores  
National Automotive Test Tracks (NATRAX),  
NH-52, Old Agra- Mumbai Highway.  
Near to Pithampur Flyover,  
Post Khandwa (Near Pithampur),  
Dist. Dhar (M.P.)-454774

Dear Sir,

We, the undersigned, offer to provide the contract services in accordance with your Tender No. -----  
----- and our Technical Bid, dated.....

Our attached Financial Bid includes the price in the format for financial bid provided (BOQ) as part  
of tender documents. The total price of our offer is INR \_\_\_\_\_ (in  
figures and words) and includes all the deliverables under this tender as per our Technical Bid.

The above total bid price includes a price discount/rebate (if any) of .....% (in figures and words)  
OR INR.....(in figures and words).

We hereby declare that all the information and statements made in this Bid is true and complete in  
all respects and is as per the guidelines and terms & conditions laid down in the tender document.  
We further understand that our financial bid is subject to scrutiny/arithmetical checks and any  
information which is found false or is not as per the guidelines and terms & conditions of the tender  
document may lead to our disqualification.

Our Financial Bid shall be binding upon us subject to the modifications resulting from Contract  
negotiations, up to expiration of the validity period of the Bid.

We understand NATIS has right to accept or reject our Bid or split the works among the bidders for  
the purpose of award, as per its discretion.

Yours sincerely,

Authorized Signature [In full]: \_\_\_\_\_

Authorized Signature [In initials]: \_\_\_\_\_

Name and Title of Signatory: \_\_\_\_\_

Name of Firm: \_\_\_\_\_

Address: \_\_\_\_\_

[Note : To be signed in blue ink]



### Section 14 Bill of Quantities (BOQ)

S.No.	SOR ref	Description of Item	Unit	Quantity	Rate incl GST in Rs	Amount incl GST (In Rs.)
1	5.28.4	<p>Providing and laying in position machine batched and machine mixed design mix M-40 grade cement concrete for reinforced cement concrete work, using cement content as per approved design mix, including pumping of concrete to site of laying but excluding the cost of centering shuttering, finishing and reinforcement, including admixtures in recommended proportions as per IS: 9103 to accelerate, retard setting of concrete, improve workability without impairing strength and durability as per direction of Engineer-in-charge. (Note :- Cement content considered in this item is @ 340 kg/cum. Excess/ less cement used as per design mix is payable/recoverable separately).</p> <p>All works upto plinth level</p>	Cu.m	40.00		
2	5.9.2.1	<p>Centering and shuttering including strutting propping etc and removal of form for</p> <p>Foundation footing bases of columns etc for mass concrete</p>	Sqm	25		
3	10.1	<p>Steel work welded in built up sections/ framed work, including cutting, hoisting, fixing in position and applying a priming coat of approved steel primer using structural steel etc. as required</p> <p>In gratings, frames, guard bar, ladder, railings, brackets, gates and similar works</p>	Kg	2100		
4	5.16.6	<p>Steel reinforcement for R.C.C. work including traightening, cutting, bending, placing in position and binding all complete upto plinth level. Thermo-Mechanically Treated bars (DSR-18, Item 5.22 P-98)</p>	Kg	0.89		





S.No.	SOR ref	Description of Item	Unit	Quantity	Rate incl GST in Rs	Amount incl GST (In Rs.)
5		Supplying of steel fibers for concrete work of specified dia. & length @ 8Kg./cum complete as per drawing and Technical specification .	Kg	113.48		
6		Providing and fixing 1mm thick GI Sheet for RCC block shuttering welded with MS angle frame of required size,	Kg	1400.00		
7		Providing, bending and fixing of 19mm round SS bar in RCC weighth block for handling (1.0 meter long).	Each	112.00		
Total Amount (incl. GST) Rs. in figures						





ANNEXURE -V

NATRAX Bank details to be used for submission of EMD/Tender Fee (if any) & procedure for password protection

The image shows a cancelled cheque from Bank of Baroda. The cheque is dated 07/07/18 and is payable to the order of the bearer. The amount is written as ₹ 000000. The MICR line at the bottom reads: \*000001# 4520120264 011758# 51. The cheque is marked with a large handwritten 'CANCELLED' and a signature. The bank details are: Bank of Baroda, Baroda, PIN 454775, RTGS/NEFT ID CODE: BARB00THAM. The cheque is for the National Automotive Test Tracks (NATRAX) Division.

Steps for loading passwords in PDF Files-Method I

Step 1- please open PDF file and click on "Advance" tab.



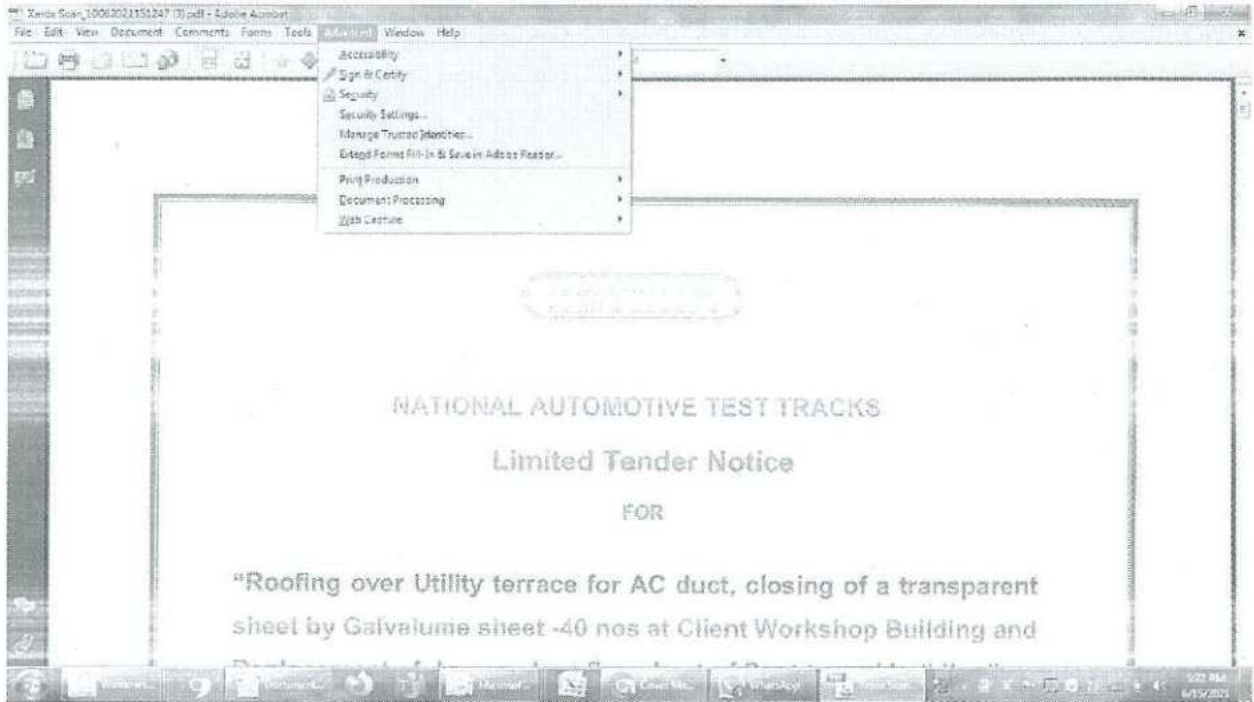
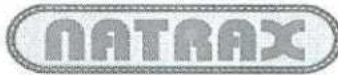

Step 2- in the advance tab, please click on the "Security" tab.

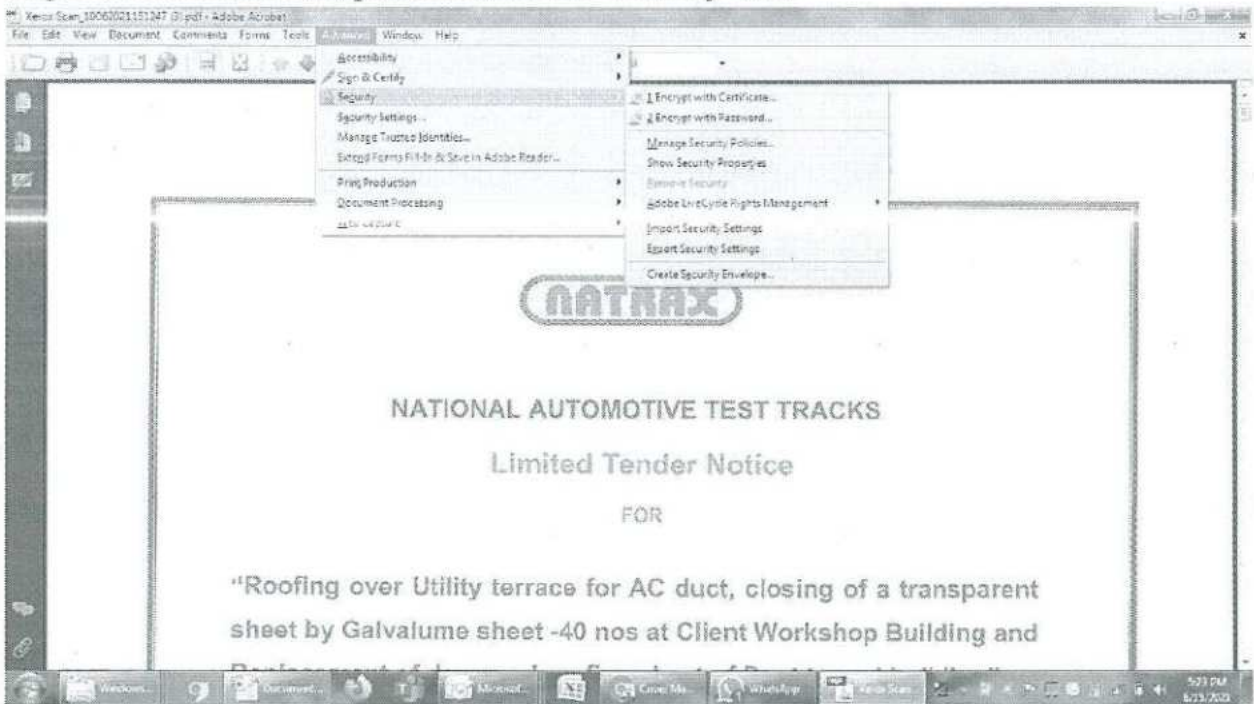

Step 3- in security tab, please click on "2 Encrypt with Password".



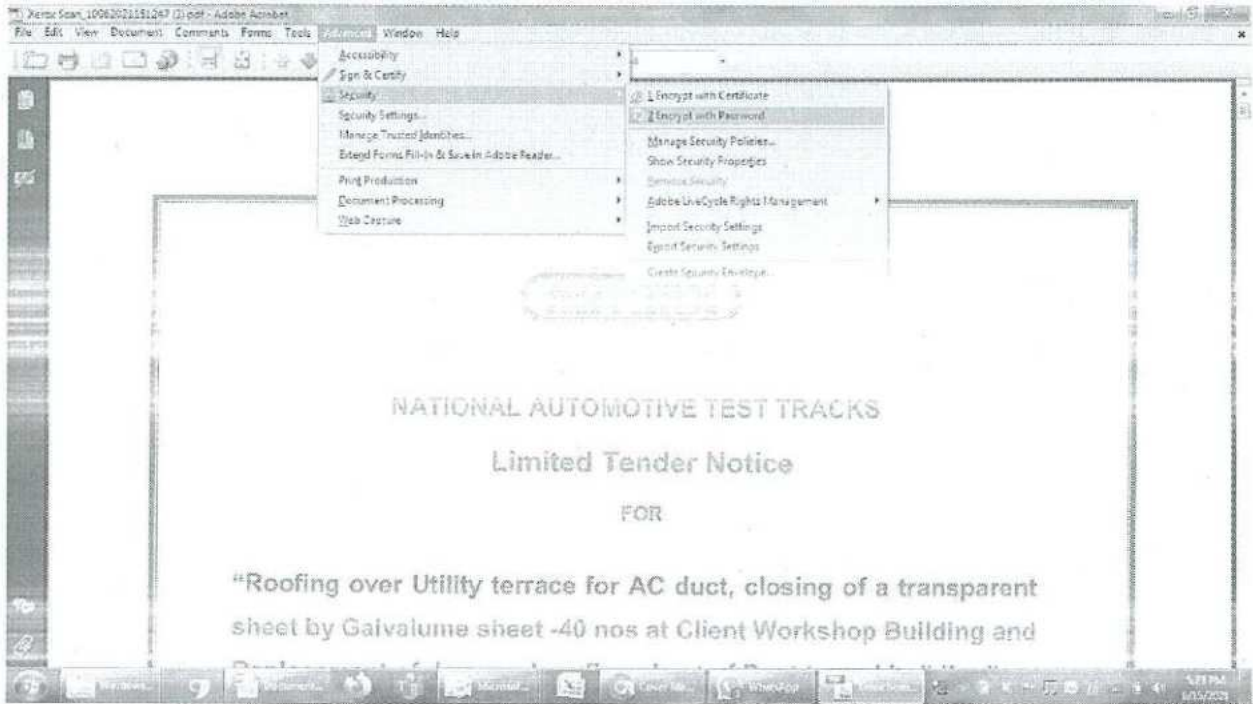

Step 4- after that below window will open, please check in option "Required a password to open the document". Then please fill password and click "ok".

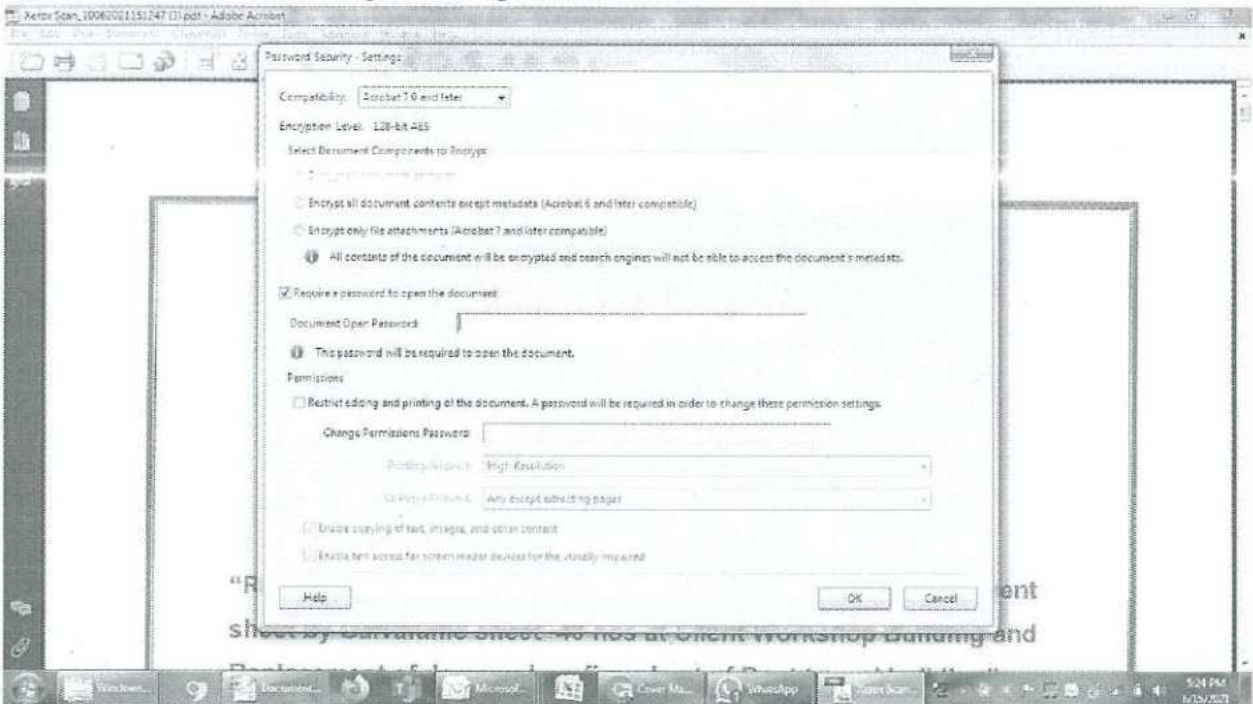

Step 5- after that below window will be open, please fill same password again, and click "ok".

